

Disassembly Analysis of Slates: Design for Repair and Recycling Evaluation

Final Report

Version July 2014

Karsten Schischke
Dr. Lutz Stobbe
Gergana Dimitrova
Sascha Scheiber
Markus Oerter
Torsten Nowak
Alexander Schlösser
Hannes Riedel
Dr. Nils F. Nissen

Berlin, July 31, 2014

Fraunhofer IZM
Dept. Environmental & Reliability Engineering
Gustav-Meyer-Allee 25
13355 Berlin
Germany
Tel.: +49.30.46403-156
Fax: +49.30.46403-211
Email: karsten.schischke@izm.fraunhofer.de



This analysis has been performed independently by Fraunhofer IZM. Green Electronics Council (GEC) cordially supported this project through financial support to acquire the devices under test. Green Electronics Council staff commented on interim findings but did not influence in any way the outcomes of the study.

Content

1	Introduction and Objectives	5
2	Devices under test	7
3	Description of tasks	9
3.1	Thermography	9
3.2	Disassembly test and analysis	9
4	Thermography and thermal assessment	13
4.1	Preparation of performance benchmark and thermography	13
4.2	Thermography procedure	14
4.3	Thermography results	15
4.4	Thermography assessment	17
5	Disassembly test and data collection	19
5.1	Documentation of the disassembly process	19
5.2	Data collection and evaluation metric	19
5.3	Knowledge of disassembly procedure in advance	21
5.4	Number of used tools and need of specialized tools	22
5.5	Fasteners (screws, clips, connectors, and adhesives)	23
5.6	Number of steps	24
5.7	Disassembly data results all DUTs	25
6	Individual analysis: Opening of DUTs	27
6.1	Disassembly data	27
6.2	Analysis of individual product designs	29
7	Individual analysis: Removal of battery	41
7.1	Disassembly data	41
7.2	Analysis of individual product designs	43
8	Individual analysis: Dismantling of mainboard	53
8.1	Disassembly data	53
8.2	Analysis of individual product designs	54
9	Individual analysis: Dismantling of remaining parts	64
9.1	Disassembly of the display module	64
9.2	Dismantling of inner frame	72
10	Repair perspective	73
11	Recycler perspective	76

11.1	Recycling perspective	76
12	Summary	80
12.1	Thermal issues	80
12.2	Design considerations for the first scenario – repair and refurbishment	80
12.2.1	Opening of the device	80
12.2.2	Removal of battery	81
12.2.3	Dismantling of mainboard	82
12.2.4	Dismantling of display unit	82
12.3	Design considerations for the second scenario – commercial recycling for optimal material recovery	83
12.3.1	Opening of the device	83
12.3.2	Dismantling of housing or frame	84
12.3.3	Removal of battery	84
12.3.4	Dismantling of mainboard	84
12.3.5	Dismantling of display unit	85
12.4	Repair perspective	85
12.5	Recycling perspective	86
12.6	Additional Observations and Outlook	87

1 Introduction and Objectives

This project was initiated by Fraunhofer IZM, Berlin, to investigate the current status of slate designs with respect to repair and recycling.

The first report was published in August 2013. In the following months, interviews with German recycling companies were conducted in order to track the recycling practices at present time as well as the future proceedings. Additionally, American and German experts with vast experience in repair of electronics were interviewed. The findings are commented in chapter 10 and 11.

Following the Energy Star definition, slate computing devices are defined “as a type of computer lacking a physical keyboard, relying solely on touchscreen input, having solely a wireless network connection (e.g., Wi-Fi, 3G), and primarily powered from an internal battery (with connection to the mains for charging, not primary powering of the device).”¹ Green Electronics Council supported this project. An overarching objective upon request by GEC is to create an independent evidence base for future stakeholder discussions on EPEAT criteria for slates. It is not the objective of this study to propose such criteria, nor did the study take into account all facets to define such criteria. Definitely, additional aspects and arguments need to be considered thoroughly in the course of the upcoming stakeholder process.

The projects aims to assess the ease of dismantling slates by experimental teardowns of various devices under test (DUTs), including

- disassembly processes (based on laboratory findings, no disassembly under real recycling conditions)
- difficulty and need for special tools
- methodologies for depollution – battery, circuit board, etc. removal
- identification and discussion of good D4R examples (design for repair, refurbishment, reuse, and recycling)
- reflection on best end-of-life practices for repair, life extension, refurbishment, and upgradability

¹ In Europe the term tablet, tablet PC or tablet computer is much more frequently used as a synonym for what is defined as slates in the Energy Star specification 5.2 for computers.

- reflection on suitable product information from manufacturers that would be of value to repairers, refurbishers and recyclers

2 Devices under test

The selection of the devices under test (DUT) includes the following criteria:

- Display size (7" and 10" class)
- Performance (CPU, RAM, storage, battery, operation system)
- Price category (120€ to 600€)
- Market relevance (sales rankings, reviews, novelty)

In January 2013 a total of ten different slates have been purchased and another ten in April 2013. A further slate was provided by Dell which features as the only product a direct option to change the battery without otherwise opening the device.

Table 1 shows the 21 products and their technical parameters that comprise the DUTs in the disassembly test (order of product names in this table is not correlated with the DUT numbers used later on).

Product Name	Display Size in Inc	Processor	RAM in GB	Storage in GB	Battery Capacity in mAh	Battery Energy in Wh
Odys Neo X7	7,0	1 x 1,2 GHz, ARM Cortex-A8	0,5	4	3000	11,1
Asus Google Nexus 7	7,0	4 x 1,3 GHz, Nvidia Tegra 3 (A9)	1,0	32	4270	16,0
Lenovo IdeaTab A2107A	7,0	1 x 1 GHz, MediaTek 6575 (A9)	1,0	16	3700	13,7
Kindle Fire HD	7,0	2 x 1,2 GHz, OMAP 4460 (A9)	1,0	16	4440	16,4
Huawei Media Pad 7	7,0	2 x 1,2 GHz, Qualcomm MSM8260	1,0	8	4100	15,0
Intenso TAB714	7,0	1 x 1 GHz, ARM Cortex-A8	0,5	4	2400	8,8
Samsung Galaxy Tab 2	7,0	2 x 1 GHz, Samsung Exynos	1,0	8	4000	14,8
Toshiba AT270	7,7	4 x 1,3 GHz, Nvidia Tegra 3	1,0	32	3940	14,6
Apple iPad mini	7,9	2 x 1 GHz, Apple A5 (A9)	0,5	16	4440	16,5
Sony Xperia Tablet S SGPT121DE/S	9,4	4 x 1,3 GHz, Nvidia Tegra 3 (A9)	1,0	32	6000	22,2
Blaupunkt Discovery	9,7	2 x 1 GHz, Nvidia Tegra 2 (A9)	1,0	16	7600	28,0
Apple iPad 4	9,7	2 x 1,4 GHz, Apple A6x	1,0	16	11560	43,0
Odys Noon	9,7	2 x 1,6 GHz, ARM Cortex-A9	1,0	16	7800	28,8
Samsung Galaxy Note 10.1	10,1	4 x 1,4 GHz, Exynos 4412 (A9)	2,0	16	7000	25,9
Acer Iconia A510	10,1	4 x 1,3 GHz, Nvidia Tegra 3 (A9)	1,0	32	9800	36,0
Asus Transformer TF300TG	10,1	4 x 1,3 GHz, Nvidia Tegra 3 (A9)	1,0	32	2940	22,0
Asus MeMo Pad Smart ME301T	10,1	4 x 1,2 GHz, Nvidia Tegra 3	1,0	16	5070	18,4
Dell Latitude 10	10,1	2 x 1,8 GHz, Intel Atom Z2760	2,0	64	3880	30,0
Samsung Google Nexus 10 GT-P8110	10,1	2 x 1,7 GHz, ARM Cortex-A15	2,0	16	9000	33,8
Dell Latitude 10 ST2	10,1	2 x 1,8 GHz, Intel Atom Z2760	2,0	64	3880	30,0
Acer Iconia W700	11,6	2 x 1,5 GHz, Intel Core i3-2375m	4,0	64	4850	54,0

Table 1: Devices under test (DUTs)

In the following analysis no brand names are mentioned as it is explicitly not intended to compare or rank individual products, but to analyse design

principles as such. For the same reason any brand names have been masked in the photo documentation.

3 Description of tasks

3.1 Thermography

Preceding the disassembly analysis the DUTs underwent a performance benchmark test during which the thermal behavior (heat distribution) was documented by multiple thermography images.

The thermography is part of this analysis as some thermal management design issues might affect the disassembly and material composition. Reflecting on thermal issues first helps to consider later on, whether certain design measures might be due to thermal considerations.

The **thermal analysis** includes the following tasks:

- Thermal images of DUT backside (performance benchmark test running with and without external power supply)
- Thermal images of DUT open/without back-cover (performance benchmark test running with and without external power supply)
- Analyzing the thermal characteristic in correlation to:
 - Overall thermal behavior (peak temperatures, hot spots, heat distribution, etc.)
 - Respective design decisions (material selection, component positioning, form factor, means of heat management, etc.)
 - Specific interest in the thermal impact on the battery pack (possible reason for aging or reduced lifetime of the battery)

3.2 Disassembly test and analysis

The data foundation for the disassembly analysis results from the following **disassembly steps**:

- First step: **Opening of the DUTs** with the least amount of damage as possible (non-destructive). The objective of this test phase is to document the opening process and to obtain quantitative data with respect to the complexity and difficulty of this disassembly process.
- Second step: **Removal of the battery** with the least amount of damage as possible (non-destructive). The objective of this test phase is

to document the battery removal and to obtain quantitative data with respect to the complexity and difficulty of this disassembly process.

- Third step: **Dismantling of the mainboard** with the least amount of damage as possible (non-destructive). The objective of this test phase is again to obtain quantitative data with respect to the complexity and difficulty of this disassembly process.
- Fourth step: **Dismantling of remaining parts** including the display unit and inner frame with the least amount of damage as possible (non-destructive). The objective of this test phase is again to obtain quantitative data with respect to the complexity and difficulty of this disassembly process.

The **disassembly analysis** will be based on the data obtained from the disassembly exercise. The analysis will distinguish following **two scenarios**:

- First scenario – **repair and refurbishment**: The objective this first scenario is the non-destructive removal and possible replacement of main subassemblies with the aim to repair and refurbish the product for an extended lifetime.
- Second scenario – **commercial recycling**: The objective of this second scenario is a fast and economical disassembly with the aim to remove the battery (WEEE compliance) and to separate valuable material fractions for effective recycling.

With respect to the first scenario the focus of the analysis is placed on the reversibility (damage-free) of the fastening mechanisms and the complexity of the dismantling process.

On the contrary, for the second scenario the simplicity and speed of the dismantling process will be the dominant factor and therefore the focus of the assessment. An inherent assumption of this work is that, in order to achieve optimal recovery of embodied resources, these products will not be shredded whole, even after depollution. In order to achieve optimal resource recovery a level of manual disassembly will be desirable before shredding.

It is expected that the disassembly assessment for the two scenarios create different results for individual products (DUTs). Against that background the disassembly test and subsequent analysis will aim primarily on the collection of data (quantification) and accurate documentation of the test results. The data collection and analysis has the following general objectives:

- The identification, comparison, and evaluation of the individual opening mechanisms and the resulting access to the components.

- The evaluation of the complexity of the disassembly of battery, mainboard, display or other subassemblies. This includes assessing the number of steps, fastening mechanisms, ease of separation and occurring damages.
- The identification of good practice designs with respect to the first and second disassembly scenario. Discussion (but not a comprehensive analysis) of related design aspects including product stability, form factor, thermal management, etc.

Note (disclaimer):

- Although the first disassembly scenario addresses the replacement of the battery or other subassemblies, this study does not include the task to answer the question whether a replacement of the battery is required. A testing and assessment of the batteries as well as the lifetime characteristics of other subassemblies are not part of this study. We strongly recommend however to consider these aspects, when discussing the design for repair, refurbishment and recycling of products and the aspect of battery replacement in particular.
- In this study all findings are based on a non-destructive product disassembly. The analysis does not include any physical tests regarding material separation through explicitly destructive approaches (breaking apart components, other kind of mechanical stress, crushing or shredding processes).
- This study has also not the objective to rank individual product designs with respect to a best design for recycling¹. The disassembly analysis nevertheless provides quantitative data and information that indicates easy of disassembly. When evaluating this “easy of disassembly” we strongly suggest keeping in mind the whole product life cycle including a demanding use phase that requires stability and robustness.
- The disassembly analysis has not the objective to determine exact dismantling times. Depending on available information, training and tools, the dismantling time (and quality) might differ significantly in comparison to the one-time test conducted in this project.

Initially it was intended to quantify process times for recycling or repair, but despite a comprehensive research for suitable metrics it turned out, that none of these available metrics (which are typically rather for larger products, such as white goods, but not mobile IT devices) is applicable unambiguously for slates. In particular the approach for non-destructive disassembly for repair, deep level

¹ For this reason the DUTs in the following analysis are not named by their model and manufacturer name, but by number from DUT_1 to DUT_21. The order of numbering does not correspond with the listed order in [Table 1](#).

(destructive) dismantling for recycling and shredder-based recycling is so different, that by now, no metrics can address properly the design specifics of slates. Applying any such metric would give the impression of a level of accurateness, which is not justified. Therefore we abstained from stating any disassembly times and focus on the design facts and differences we faced when going through the disassembly exercise.

4 Thermography and thermal assessment

4.1 Preparation of performance benchmark and thermography

For the thermal analysis the configuration of all DUTs was standardized incl. maximum display brightness and disabling of power management features. A system monitoring tool was installed as well.

The *Relative Engine 3* Benchmark (app) was installed on eight DUTs of the first batch (Figure 1). This benchmark proved to create the most significant workload on the devices in comparison to other benchmark programs and methods. The performance benchmark app required that the network interfaces (WLAN / cellular) are activated.



Figure 1: First batch DUTs performance benchmark

For DUT_10 the benchmark app was not available. No performance test was conducted. The DUT_06 did not support the app and the devices crashed multiple times. No performance test was conducted. In the case of DUT_07 the display (front side) instead of the backside had to be removed.

For the first set of thermography (image of closed DUT), a layer of black varnish was applied to outer cover of the DUTs in order to reduce reflections which would cause false results (see Figure 2).



Figure 2: DUTs coated for thermography

For the second set of thermography (image of opened DUT), the black varnish had been considered as well, but it was decided not to apply any coating, due

to the fact that that the coating is difficult to be removed e.g. from the populated printed circuit board (which would have hindered consecutive disassembly and material identification). The resulting thermal images show therefore some reflections. They are nevertheless viable for the intended purpose.

4.2 Thermography procedure

The thermal images were taken with the FLIR camera Termo Vision 6000 applying a 22mm lens without distance ring. The warm-up period for the camera was one hour. The data were processed with the software IR Control v.4.5.9.

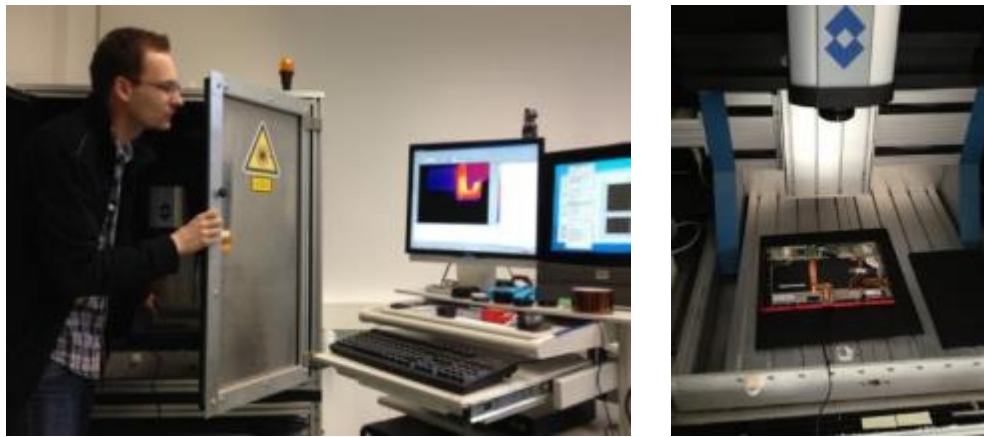

Figure 3: Thermography set-up

A total of eight DUTs (1st batch) were tested on January 29th 2013 (closed state) and on January 31st 2013 (opened state). The thermography was conducted in the same room and under the same temperature conditions (20°C). The camera and DUTs were placed in a specialized chamber, with the camera fixed in order to control its position.

Each DUT went through a preheating phase of two hours to reach stable conditions. For each DUT a total of four thermography images were taken including all DUTs closed and opened as well as with and without external power supply (EPS) connected. The thermography results (all images) have been calibrated to 50°C maximum temperature allowing a comparative analysis.

Running the benchmark app for an extended time while having the unit connected to the grid has to be considered as an extreme application scenario, which rarely will correspond to typical use patterns.

4.3 Thermography results

Figure 4 shows as a typical example the thermography images of the DUT_01 including all four images:

1. Top-left: Backside of unopened DUT without EPS connected
2. Top-right: Backside of unopened DUT with EPS connected
3. Bottom-left: DUT with back-cover removed without EPS connected
4. Bottom-right: DUT with back-cover removed with EPS connected

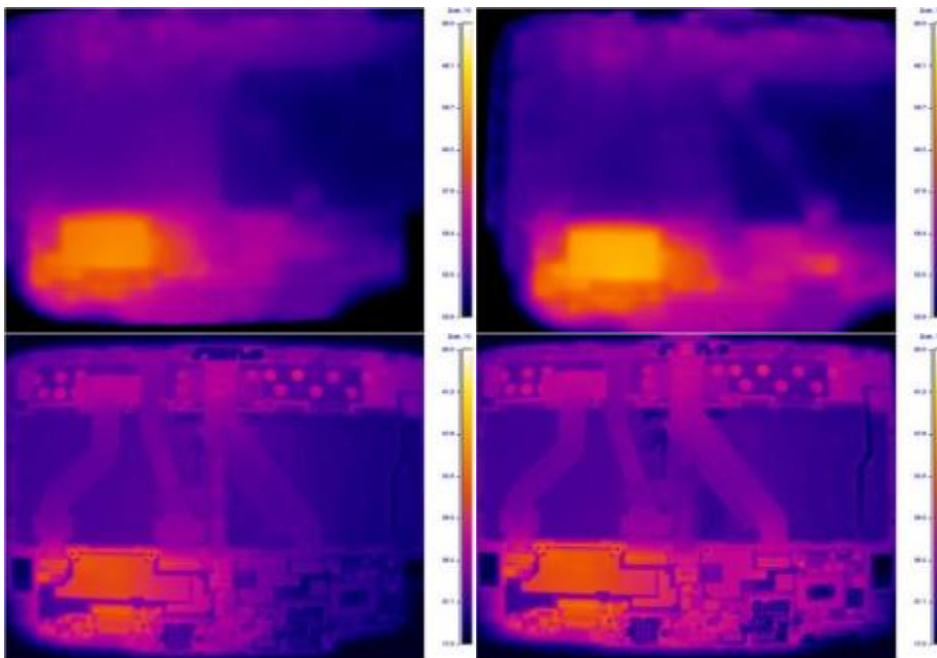

Figure 4: DUT_01 thermography results

The results of the thermography provide an indication of the heat distribution and thermal management design of each DUT.

In the closed state (top pictures) the heat distribution of the main active components e.g. processor, radio interfaces are visible. The active components are situated on the printed circuit board (PCB) and in most cases covered with EMI (electromagnetic interference) shields. These EMI shields and tapes are metal based and cover typically one or more active devices (larger rectangular shape). The EMI shields contribute to a more even and wider heat distribution. The disassembly of the DUTs showed that the polymer back-cover of some products were partially metal-coated (Cu/Ni to be confirmed). This design contributes further to an even heat distribution. The DUT_07, DUT_02 and some others featured metal (apparently Al) back-covers with very even heat distribution (see Figure 5).

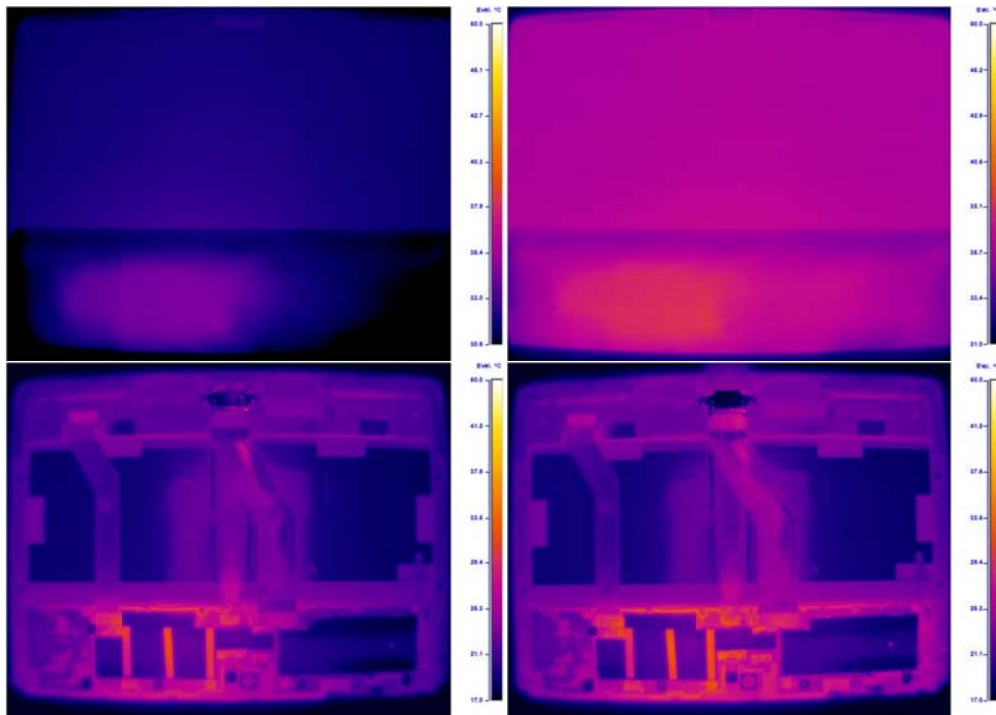

Figure 5: Thermography results DUT_02

In the open state (bottom pictures) more details are visible. Due to the fact that the PCBs have not been covered with a non-reflective coating, some reflections can be noticed in the pictures. The DUT_03 is a good example where reflection of EMI shields can be seen on the right side (see [Figure 6](#)).

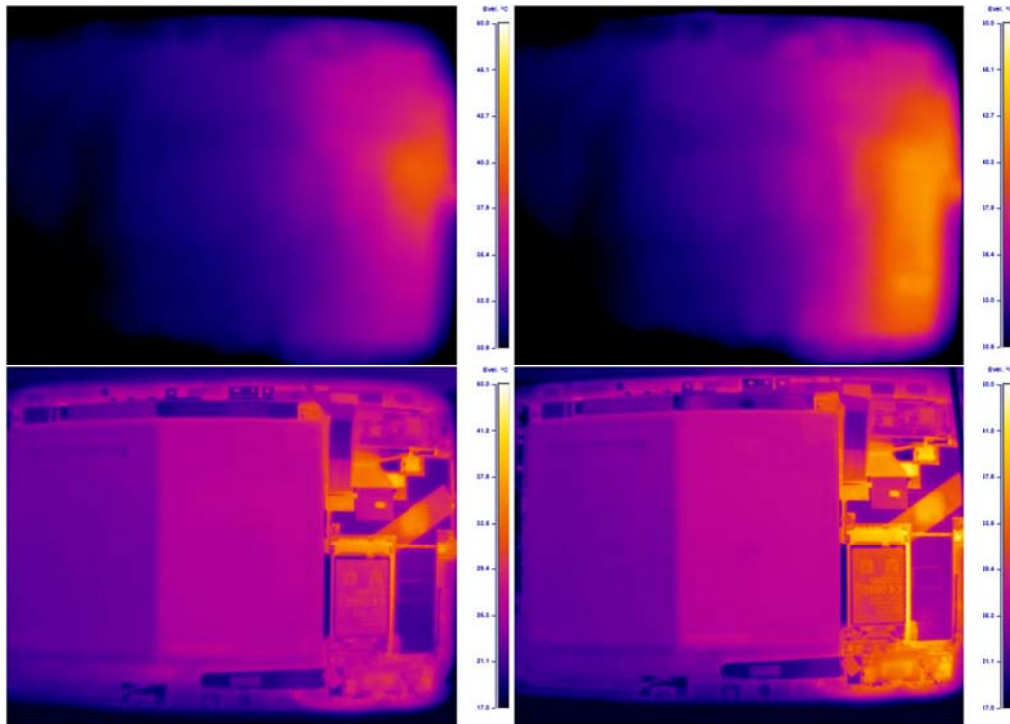

Figure 6: Thermography result DUT_03

This means that the image of the heat distribution (two-dimensional) is more correct in terms of depicted temperatures in the closed state, but less precise in terms of internal temperature resolution. Nevertheless the thermography images in the open state are very useful. For example; the connected external power supply unit and respective charging of the battery is in all cases visible by an increase of the local temperature on the battery connectors. This indicates that charging is increasing the temperature not only of the connector but also of the battery.

4.4 Thermography assessment

The main findings are:

- (1) Temperature hot spots in all cases are with the electronics (individual ICs), not the batteries
- (2) None of the DUTs contains particularly temperature sensitive electronic components (i.e. no electrolytic capacitors), which leads to the conclusion, that the observed temperatures on the electronics parts do not have a significant impact on product lifetime.
- (3) Temperatures of the batteries in all cases are only slightly elevated (if at all) under charging and while the benchmark app is running. Temperature increase is by approximately 10 K maximum. Although in general any temperature increase reduces battery lifetime, this

moderate temperature increase is considered not to have a major influence on battery lifetime. Note, that we did not investigate the influence of the operating temperature on actual battery lifetime (battery performance and lifetime testing not included in this analysis).

- (4) In some cases apparently heat spreads from the electronics part to the battery (see [Figure 6](#), where the battery cell located closer to the electronics shows a slightly higher temperature).
- (5) Given the generally low temperature increase of the batteries, the housing material (plastics or metal) does not have a major thermal effect. Metal as such works as a good heat spreader, and indeed in one case with a metal housing the overall temperature remains on a low, even level (DUT_07). However, in the case of the other DUT with metal housing (DUT_02, see [Figure 5](#)) the impression is that the heat removed from the electronics part is spread also towards the part, which covers the battery and might even increase battery temperature compared to a less thermal conductive housing material.

These findings are limited by the above mentioned constraints and the fact, that thermal conditions of an opened device are different to a closed device. More precise data and evidence could be gained only with implemented temperature sensors complementing thermography.

5 Disassembly test and data collection

5.1 Documentation of the disassembly process

The disassembly of the DUTs has been prepared by:

- Creation of a disassembly protocol for the purpose of data collection (excel file)
- Identification and analysis of existing teardowns (online) and available disassembly guidelines
- Tests for picture documentation of the single disassembly steps. A scanner will be used instead of a camera

For each step the disassembly protocol includes following data / information:

- Type and number of used tools (standard tools, special tools),
- Type and number of fasteners (screws, clips, adhesives, connectors),
- Weight and size of disassembled parts,
- Time duration of an individual disassembly step
- Qualitative evaluation (degree of difficulty, occurred damages, etc.)

These quantitative data and information provide the basis for the evaluation of the disassembly process and individual product designs.

The disassembly protocol is complemented by a photo documentation of observed design features.

5.2 Data collection and evaluation metric

With the objective to document and evaluate the “ease of disassembly” and respective “good practice design” a simple data collection and evaluation metric was developed. The evaluation is based on expert knowledge and simply considers aspects that attribute positively or negatively to the non-destructive disassembly process.

The quantitative and qualitative data obtained for each step of the disassembly process provide a suitable set of aspects in that respect. In this study we documented each aspect individually and without an initial ranking. The data set includes:

- Number of screws
- Number of clips
- Type of screws
- Adhesive (one-sided) in cm²
- Adhesive (two-sided) in cm²
- Adhesive (two-sided, heat) in cm²
- Number of tools
- Number of special Tools
- Number of connectors
- Number of steps

With respect to different disassembly scenarios and design requirements the individual characteristics of these aspects might change from a positive to a negative attribute. As an example, a screw is a secure fastener, provides stability and is reversible. These attribute are positive in an extended lifetime and repair scenario. On the other hand, too many screws or different kind of screws as well as bad access to the screws will influence the time and economy of the disassembly process in a negative way. Another example is the number of tools; a small number of tools needed for the disassembly process would be generally positive and preferable in comparison to a higher number of tools.

The evaluation will reflect the selected two scenarios (see Chapter 3.2). With respect to the first scenario (replacement of battery, mainboard, and display) the focus has been placed on minimum damage and possible reversibility of the disassembly process. We are also considering in our assessment that the opening mechanism is known and the disassembly is done by a professional service provider.¹

With respect to the second scenario (dismantling for recycling) the time factor is more important and damage to the product acceptable (except for the battery). This scenario reflects professional conditions at a designated recycling location. In this case the “knowledge of the disassembly procedure in advance” would probably support a faster and more damage-less disassembly.

¹ The DUT's product manuals provide few or no information on the opening mechanism or complete disassembly procedure.

5.3 Knowledge of disassembly procedure in advance

The opening of the first batch of DUTs and the removal of the battery showed already the different design approaches of the various manufacturers. Typical examples where previous knowledge of the opening mechanism would have been useful to avoid damage are shown in Figure 7.

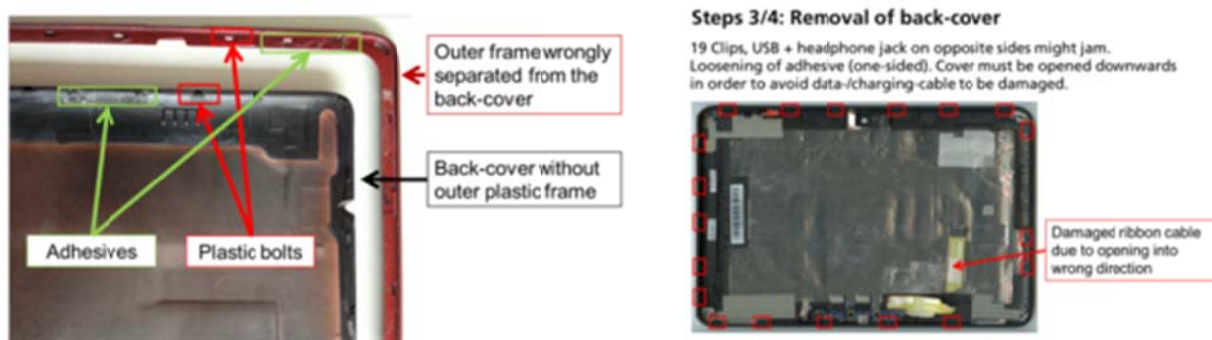

Figure 7: Wrongly opened and damaged (DUT_08 left and DUT_03 right)

If particular disassembly descriptions or videos of teardowns were available, the opening of the DUTs was much easier and less destructive. It is justified to conclude that in most cases “knowledge of the disassembly procedure in advance” and most importantly of the opening mechanism improves the disassembly quality and (time) effectiveness.

It has to be noted, that e.g. a contract repair agency for an OEM might not need disassembly instructions with each manual as those are experienced to repair frequently the same product model. For a small repair shop or an experienced consumer this information is helpful to do the repair right. Relevancy of this criterion consequently depends on who is supposed to do the repair.

A good example of product documentation by a manufacturer is depicted in Figure 8: Lenovo publishes comprehensive service manuals for slates and other products online¹, describing in detail opening mechanisms and further process steps to replace individual components.

¹ http://support.lenovo.com/en_US/guides-and-manuals/default.page

Lenovo IdeaTab A2107A

1030 Base cover

For access, remove these FRUs in order:

- "1010 SIM card cover" on page 27
- "1020 Battery pack" on page 28

Figure 3. Removal steps of base cover

Remove 16 screws **1** on the base cover with the screw driver.

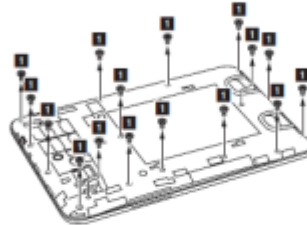

Step	Screw (quantity)	Color	Torque
1	M3.0 x 0.6mm, flat-head, nylok-coated (16)	Black	0.7 ± 0.05 kgf.cm

Remove the base cover in the direction shown by arrow **2**.

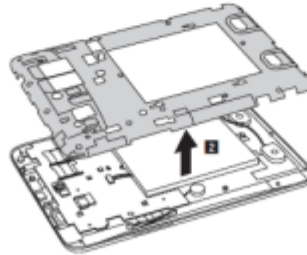

29

Figure 8: Exemplary screenshots Lenovo IdeaTab A2107 Hardware Maintenance Manual

5.4 Number of used tools and need of specialized tools

The number and types of tools needed for the dismantling is an important indicator for the easy of disassembly. It will influence the time and costs needed for a disassembly process. As a first observation; in most cases only two regular tools were needed for the opening of the device and removal of the battery. The following differentiation between regular and special tools has been made:

- Regular tools are screwdrivers (e.g. Philips 0, 00), metal and plastic spatulas, pliers and tweezers.
- Special tools are screwdrivers with special heads (e.g. torx), heat gun, thermal pad, soldering iron, etc.

Example: In one case the battery contact was soldered and needed to be removed with a soldering iron ().

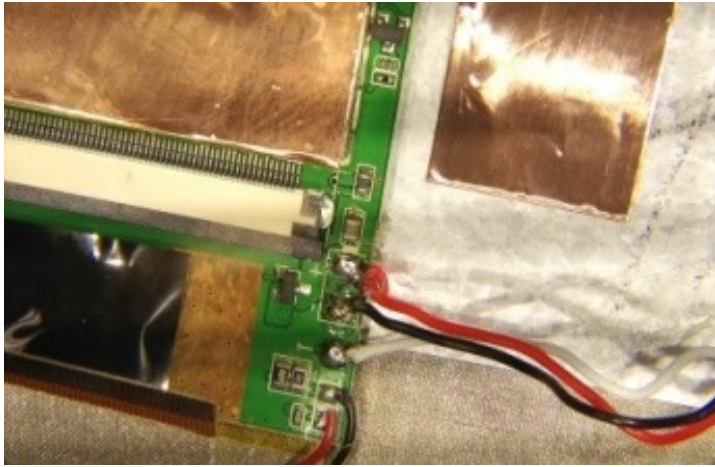

Figure 9: Battery wires soldered (DUT_04)

5.5 Fasteners (screws, clips, connectors, and adhesives)

The mechanism with which the different parts of the product are fastened is influencing the time and difficulty of the disassembly (reassembly) process. At the same time the different designs and fastening mechanism will determine the overall form, weight and stability of the product. The following four fastener mechanisms are considered:

- **Screws:** Screws are considered a very good option due to its ease of opening and reversibility. The number of different screws is an important time factor (e.g. tool change) and should be as low as possible. Different screws mean not only the distinction of different sizes and forms of the screw heads but also the distinction of different form factors of screws with the same head/tool sizes. As an additional design consideration; screws require space and are therefore critical in terms of form factor. Easy access to a screw is very important for ease of disassembly. Axially accessible screws are typically easier to remove than those, which are only accessible radially. Particular small screws might reduce overall form factors, but increase disassembly time.
- **Clips:** This is generally considered a good option. However, the number, strength, and particularly the accessibility of the clips are influencing the ease of disassembly. An assessment methodology for the evaluation of the technical properties of clips does not exist. The disassembly tests indicated that clips are to some extent problematic, because an unprofessional opening attempt as well as specific designs can lead to irreversible product damage. The location of clips should be known at least for the “change of battery” scenario.

- Connectors: These come in various sizes and opening mechanisms and are used for electrical connection. Disconnecting small connectors is a delicate work and can lead easily to damage. Nevertheless, detachable connectors are positive in both a replacement scenario and recycling scenario.
- Adhesives: This is considered a suboptimal fastening mechanism with respect to the change of battery scenario. The number, size, and tensile strength of the adhesive area (e.g. tape) are critical criteria. The functional spectrum of adhesives tape range from simple fixing to electromagnetic shielding and thermal management. For the evaluation a differentiation was made concerning one and two-sided adhesive tapes, the need for heating as well as the size (area) of the tape. Adhesives however support a small form factor and save potentially overall weight.

The statement that a minimum number of fasteners are beneficial for dismantling and repair neglects the fact that a higher number of fasteners and a larger adhesive area tends to result in an increased overall robustness and resistance against mechanical stress. To make a qualified judgment regarding robustness would require related tests, such as drop-tests, which are explicitly not covered in our analysis.

5.6 Number of steps

The number of steps indicates the complexity of the disassembly processes and influences quite often the dismantling time. We define a disassembly step as an operation that finishes with the removal of a part or the change of a tool. The first disassembly tests indicated that quite often smaller components such as a camera, cable, tape or EMI shield needed to be removed before access was possible to main components. Although it is not intended to define feasible time limits for individual steps, we observed that it takes about five seconds for a screw to be unfastened. Clips and adhesives vary in terms of required time considerably (depending on how tight or strong they are). Shown in [Figure 10](#) is a typical example, which steps are required to access the battery.

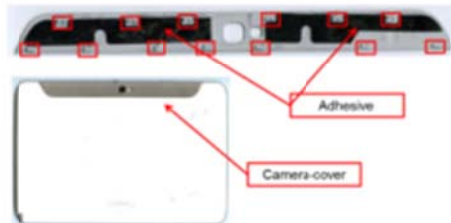
Step 1: Removal of camera-cover**Steps 2./3.: Loosening of 3 screws, removing back-cover**

20 Clips, levered with metal-spattle

**Steps 4-6: Unplugging of 4 ribbon cables, loosening of 2 adhesives (one-sided)****Steps 7-9: Loosening of 10 screws and unplugging of battery connector, removal of battery**

Figure 10: Documentation of battery removal DUT_01

5.7 Disassembly data results all DUTs

The following [Table 2](#) shows the obtained dataset from the disassembly tests. Based on these data and detailed descriptions of the individual disassembly steps for each DUT we conduct the subsequent disassembly analysis.

DUT	Opening									Battery removal									Mainboard removal											
	Number of used tools	Number of special Tools	Different screws	Number of connectors	Number of screws	Number of clips	Adhesive (one-sided) in cm ²	Adhesive (two-sided) in cm ²	Adhesive (two-sided, heat) in cm ²	Number of steps	Number of used tools	Number of special Tools	Different screws	Number of connectors	Number of screws	Number of clips	Adhesive (one-sided) in cm ²	Adhesive (two-sided) in cm ²	Adhesive (two-sided, heat) in cm ²	Number of steps	Number of used tools	Number of special Tools	Different screws	Number of connectors	Number of screws	Number of clips	Adhesive (one-sided) in cm ²	Adhesive (two-sided) in cm ²	Adhesive (two-sided, heat) in cm ²	Number of steps
DUT_01	2	0	1	0	3	33	0	16	0	3	1	0	1	5	10	0	26	0	0	6	2	0	1	17	4	0	12	2	0	17
DUT_02	2	0	1	0	10	22	0	24	0	5	1	0	1	3	4	0	2	0	0	5	3	0	2	9	4	0	2	0	0	12
DUT_03	2	0	1	1	4	30	16	0	0	4	1	0	2	2	3	0	36	0	0	8	2	0	2	13	6	2	47	1	0	15
DUT_04	1	0	0	0	0	18	0	0	0	1	1	1	0	1	0	0	24	6	0	4	2	1	1	2	5	0	41	2	0	10
DUT_05	1	0	0	0	0	20	0	0	0	1	1	0	0	1	0	0	7	0	0	2	2	0	3	7	13	0	53	0	0	8
DUT_06	1	0	0	0	1	3	0	0	0	3	1	0	1	1	15	0	0	0	0	4	3	0	1	4	16	0	1	20	0	13
DUT_07	5	1	4	2	23	0	0	1	17	9	2	1	0	1	0	0	0	0	16	3	4	0	7	10	23	0	15	17	0	44
DUT_08	1	0	0	0	0	21	0	0	0	2	2	0	2	3	8	0	19	0	0	7	3	0	2	8	7	5	0	21	0	15
DUT_09	3	0	1	0	6	4	4	0	0	7	2	0	0	3	0	0	18	21	0	7	4	0	1	9	7	0	21	22	0	19
DUT_10	1	0	0	0	0	20	0	0	0	1	2	0	2	1	5	0	11	0	0	6	3	0	2	8	6	0	16	0	0	15
DUT_11	2	0	1	1	2	19	1	9	0	3	2	0	8	0	11	0	15	11	0	9	1	0	2	9	11	0	15	0	0	8
DUT_12	1	1	0	0	0	0	0	0	35	2	3	0	2	9	7	0	1	39	0	9	3	0	2	9	7	0	1	7	0	8
DUT_13	1	0	0	0	0	22	0	0	0	1	2	0	1	3	4	0	7	0	0	5	2	0	0	7	6	0	0	7	0	6
DUT_14	1	0	0	0	0	36	0	0	0	1	1	0	0	4	0	0	0	0	0	2	2	0	2	9	11	0	0	0	0	11
DUT_15	2	0	0	0	4	34	0	0	0	4	1	0	0	1	0	0	29	0	0	2	2	0	2	7	7	2	6	0	0	10
DUT_16	2	0	0	0	2	14	9	0	0	2	2	1	0	0	0	0	17	23	0	3	2	1	1	1	3	0	31	0	0	7
DUT_17	2	0	0	0	2	13	0	0	0	2	1	1	0	0	0	0	82	14	0	3	2	1	1	3	7	0	147	0	0	8
DUT_18	2	0	1	0	5	46	0	0	0	3	1	0	0	4	12	0	15	0	0	4	1	0	1	12	1	0	16	0	0	6
DUT_19	1	0	0	0	0	23	0	0	0	1	1	0	1	1	6	0	0	0	0	3	1	0	1	10	6	0	0	0	0	4
DUT_20	1	0	0	0	0	23	0	0	0	1	1	0	1	1	9	0	5	0	0	6	1	0	0	8	6	0	9	0	0	9
DUT_21	2	0	1	0	2	31	0	0	0	2	0	0	0	0	0	0	0	0	0	2	1	0	2	11	6	0	0	0	0	4
mean value	2	0	1	0	3	21	1	2	2	3	1	0	1	2	5	0	14	7	1	5	2	0	2	8	8	0	21	5	0	12
min value	1	0	0	0	0	0	0	0	0	1	0	0	0	0	0	0	0	0	0	2	1	0	0	1	1	0	0	0	0	4
max value	5	1	4	2	23	46	16	24	35	9	3	1	8	9	15	0	82	39	16	9	4	1	7	17	23	5	147	22	0	44

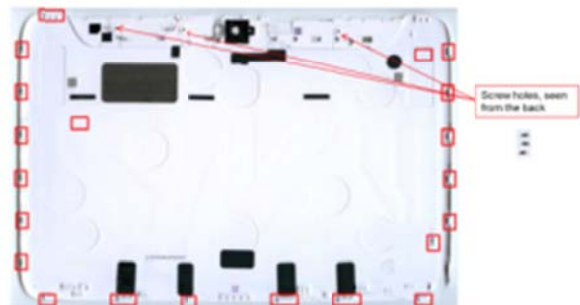
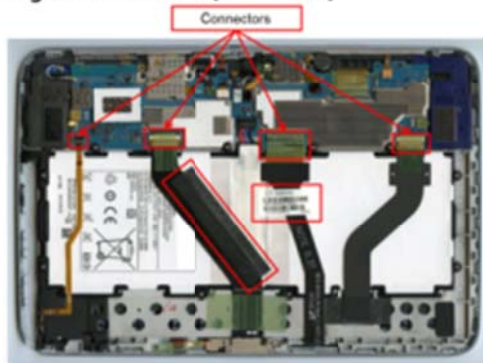
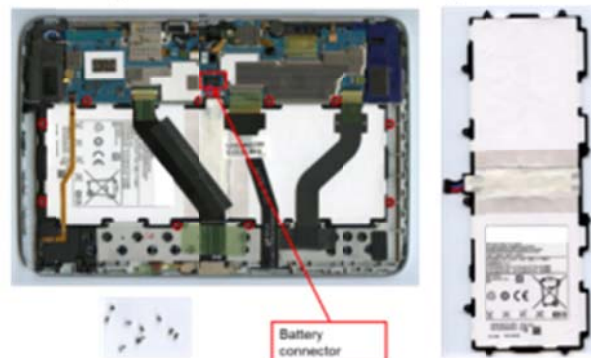
Table 2: Disassembly data overview all DUTs

For the complete workflow of removing the battery from a device only, data for opening and removal have to be aggregated. An exemption is DUT_21, which does not require an opening of the housing prior to battery removal.

In case of DUT_11 and DUT_12 the mainboard has to be removed before getting access to the battery. Data for removal of the mainboard consequently is included in the battery removal data.

Data on mainboard removal reflects the steps from opening the device and getting access to the mainboard only, disconnecting, but leaving the battery in place. For the full workflow of replacing the mainboard data for opening and mainboard removal have to be aggregated.

6 Individual analysis: Opening of DUTs

6.1 Disassembly data

The first phase of the disassembly test consists of the opening of the DUTs.

Usually the DUTs can be opened from the backside and where this was an option this approach was followed. Only very few designs allow a front side access only.

The respective analysis considers mainly the first scenario and evaluates the ease of disassembly, damage inflicted on the DUTs, and possible reassembly capability (reversibility)¹. The disassembly data for first step are shown in [Table 3](#) below.

Utilization of clips, screws and adhesives in the opening mechanism:

- A total of eight DUTs only used clips (no screws or adhesives). Five of these DUTs are smaller 7 inch devices and three are 10 inch devices. The number of clips varied from 18 to 36 clips.
- A total of six DUTs used screws and clips (but no adhesive). Two of these DUTs are 7 inch devices and four are 10 inch devices. The number of screws varied from one to ten with an average number of three screws. Mostly only one type of screw has been used. The number of clips varied from 3 to 46.
- The remaining five DUTs used a combination of clips, screws and adhesives. Two of these DUTs are 7 inch devices and three are 10 inch devices.
- In most cases the opening process could be reversed. Only in few special cases (where lots of adhesives has been used) reassembly requires specialized services.

¹ A re-assembly of the devices however was not undertaken, devices were not brought back to operational state

DUT	Opening									
	Number of used tools	Number of special Tools	Different screws	Number of connectors	Number of screws	Number of clips	Adhesive (one-sided) in cm ²	Adhesive (two-sided) in cm ²	Adhesive (two-sided, heat) in cm ²	Number of steps
DUT_01	2	0	1	0	3	33	0	16	0	3
DUT_02	2	0	1	0	10	22	0	24	0	5
DUT_03	2	0	1	1	4	30	16	0	0	4
DUT_04	1	0	0	0	0	18	0	0	0	1
DUT_05	1	0	0	0	0	20	0	0	0	1
DUT_06	1	0	0	0	1	3	0	0	0	3
DUT_07	5	1	4	2	23	0	0	1	17	9
DUT_08	1	0	0	0	0	21	0	0	0	2
DUT_09	3	0	1	0	6	4	4	0	0	7
DUT_10	1	0	0	0	0	20	0	0	0	1
DUT_11	2	0	1	1	2	19	1	9	0	3
DUT_12	1	1	0	0	0	0	0	0	35	2
DUT_13	1	0	0	0	0	22	0	0	0	1
DUT_14	1	0	0	0	0	36	0	0	0	1
DUT_15	2	0	0	0	4	34	0	0	0	4
DUT_16	2	0	0	0	2	14	9	0	0	2
DUT_17	2	0	0	0	2	13	0	0	0	2
DUT_18	2	0	1	0	5	46	0	0	0	3
DUT_19	1	0	0	0	0	23	0	0	0	1
DUT_20	1	0	0	0	0	23	0	0	0	1
DUT_21	2	0	1	0	2	31	0	0	0	2
mean value	2	0	1	0	3	21	1	2	2	3
min value	1	0	0	0	0	0	0	0	0	1
max value	5	1	4	2	23	46	16	24	35	9

Table 3: Quantitative disassembly data

6.2 Analysis of individual product designs

In this section we provide examples of typical product designs and argue their advantages and disadvantages with respect to easy of disassembly.

DUT_05 features a very simple opening mechanism and requires only one tool (metal spudger or spatula). The back-cover of DUT_05 is fastened with only 20 plastic clips on the metal outer frame (Figure 11). These clips could be opened (and closed again) without too much force and with little damage to the outer surface of the product. The clips keep the product tightly closed even after three trials of opening and closing.

Step 1: Removal of back cover

20 Clips, levered with a metal-spatula, non-destructive except some scratches

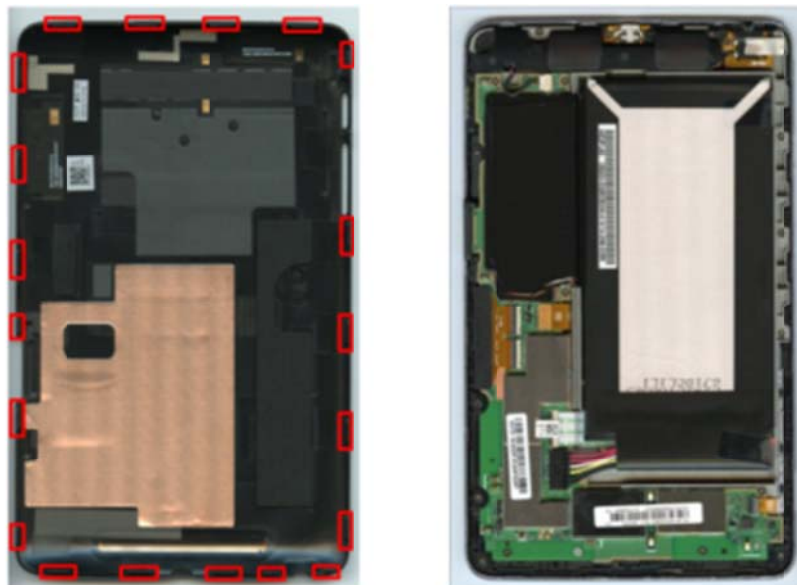

Figure 11: DUT_05 opening mechanism

DUT_13 is another example of similar simple design where the back-cover is fastened with 22 clips on the inner frame (Figure 12). The opening requires moderate force starting from the middle and working towards the corners of the product. The DUT-13 could be easily reassembled by clipping the back-cover on. The back-cover was kept snugly in place.

DUT_13 opening mechanism: back cover is fastened with 22 clips hooked to inner frame

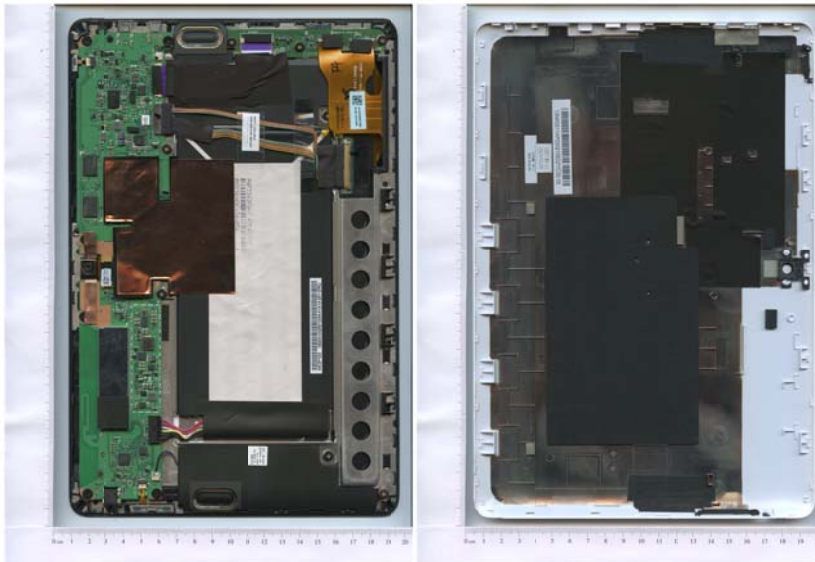

Figure 12: DUT_13 opening mechanism

Figure 13 shows details of the relative robust clip mechanism of DUT_05 with the metal socket attached to the outer frame.



Figure 13: DUT_05 clip connection

It should be noted that this slate features a similar overall thickness as other slates, where battery removal is significantly more complicated. This does not mean, that removability of a battery can be realized with any form factor: There is also another slate with an integrated battery, which is much thinner than the others, including DUT_05 and the following DUT_06. Only a comprehensive design study could unveil, whether a minimum thickness and ease of battery replacement are contradictions.

DUT_06: This was another positive example with respect to the opening mechanism. The removal of the back-cover was unique and somewhat similar to the sliding back-covers of regular mobile phones.

Figure 14 shows the opening mechanism of DUT_06. In the first step the camera and SIM-card cover needed to be pressed and slid back. This smaller cover on the top of the device is fixed by two bolt-and-notch connections and three additional clips. This cover can be relatively easily removed.

The actual back-cover is fixed with only one screw and multiple bolt-and-notch connections. Interesting is the fact that the screw is hidden under the warranty label (see again Figure 14). The opening is a little delicate but possible without any damage.

Step 1-4: Removal of camera-cover and back cover



Figure 14: DUT_06 opening mechanism

DUT_11 showed a complex opening mechanism with a combination of three plastic clips and adhesive tape as well as two screws beneath a small cover on the backside (Figure 15). Some scratches occurred and a plastic clip broke in the opening process. In general the opening process requires delicate work in order to avoid damage to the product. However, it was still possible to reassemble the device with a considerable amount of work.

Steps 1-3: Opening

Levering of plastic part (3 dips and glued). Loosening of 2 screws underneath. Levering of display part resp. popping out through the back.



Figure 15: DUT_11 opening mechanism

The specific attribute of DUT_11 is the fact that the battery and mainboard are attached to the back-cover and that the display unit is already completely detached after opening and unplugging of the display connector (Figure 16).

DUT_11 opening: Battery and mainboard are attached to the back-cover

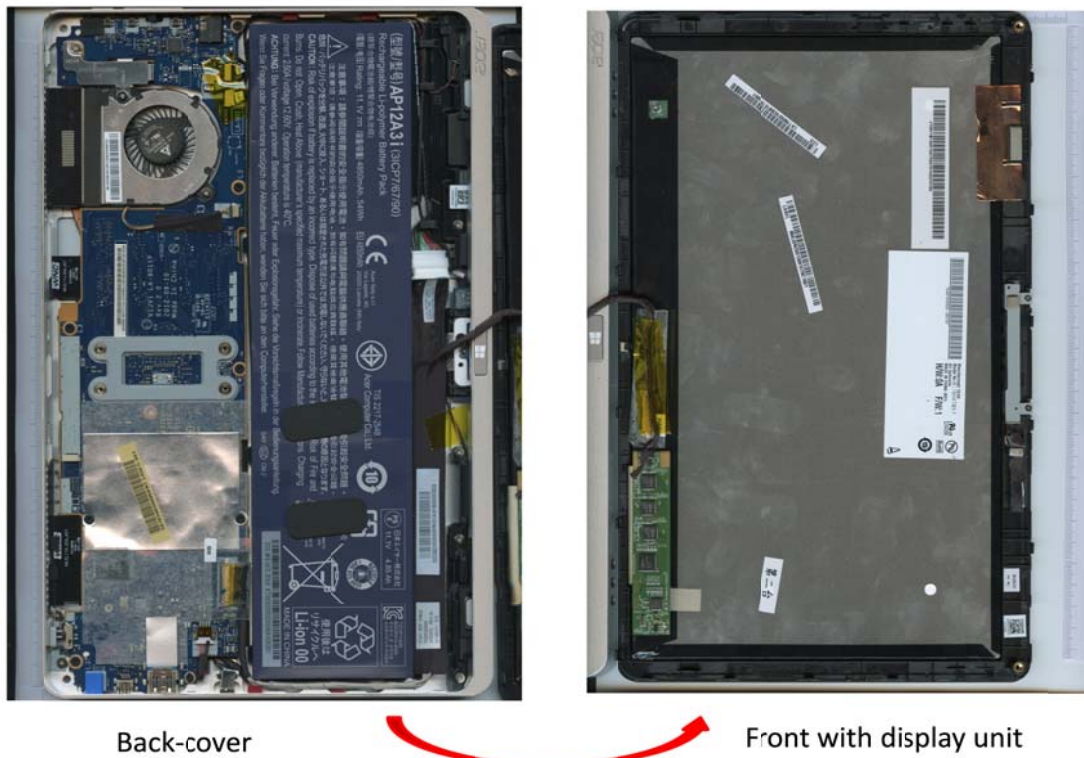

Figure 16: DUT_11 front-side and back-side after opening

DUT_01 showed medium complex opening mechanism that is reversible. The DUT could be open with a metal spattle and a screw driver. The only little drawback was the adhesive tape that supported the fixing of the camera cover (Figure 17).

Step 1: Removal of camera-cover

13 Clips, levered with a metal-spattle, adhesive tape (double-sided)

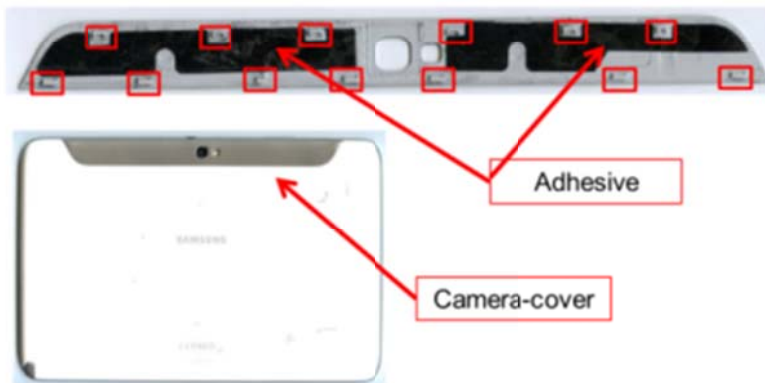

Figure 17: DUT_01 removal of camera cover

The remaining opening process was simple. The screws could be identified and loosened easily (Figure 18).

Steps 2/3: Loosening of 3 screws, removing back-cover

20 Clips, levered with metal-spattle

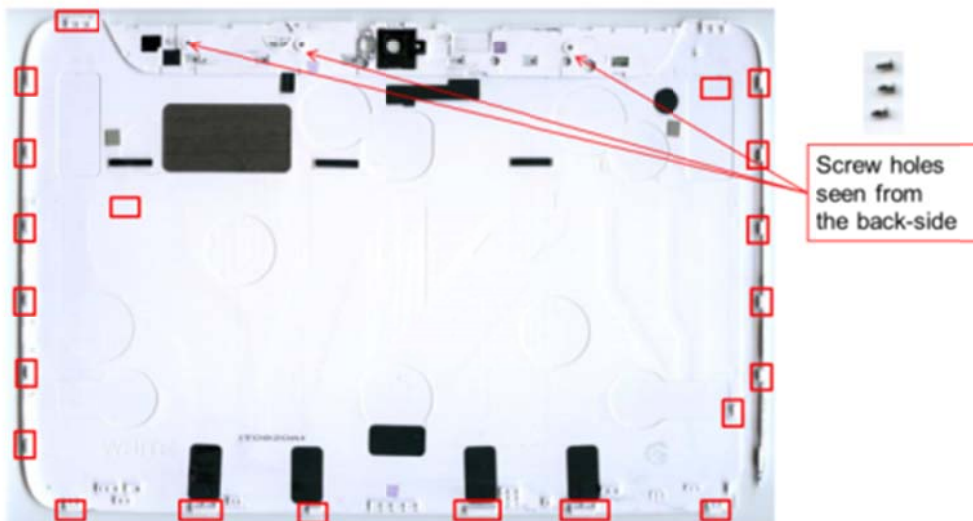

Figure 18: DUT_01 removing back-cover

DUT_08 showed a good opening mechanism as well, but only under the precondition that the opening mechanism is known in advance. Similar to DUT_05 is the back-cover connected with plastic 20 clips to the inner (magnesium) frame. The connection was very snug and some force was

necessary. There is a rubber edge on the inner frame which enables a damage-less (scratches) opening by sliding the spattle along it (Figure 19).

Step 1/2: Removal of SIM-Card-Holder and back cover

20 Clips, levered with a metal-spattle

Starting on the front on a rubber edge, there is no damage.



Figure 19: DUT_08 opening mechanism

Notice: Due to the fact that this opening mechanism was not known at the beginning, we wrongly opened the back-cover at its own little frame. During this process we damaged some smaller plastic bolts and the adhesive (see Figure 20).

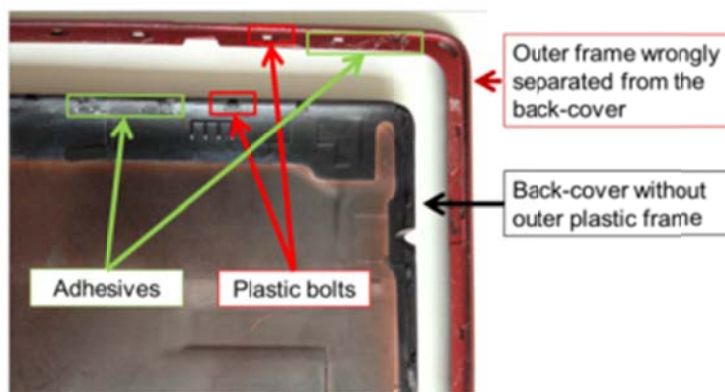

Figure 20: DUT_08 damage due to wrong opening mechanism

DUT_10 showed a relative simple opening mechanism including 20 plastic clips on the outer frame (display) with respective sockets on the plastic back-cover. Interesting to notice is the fact that the back-cover attaches quasi from the inside and is locked into the outer display frame.

Although the plastic clips and sockets are quite sturdy, we broke two of the clips (yellow marking in Figure 21).

Step 1: Removal of back-cover

20 Clips, levered with a metal-spattle, 2 were broken in opening process

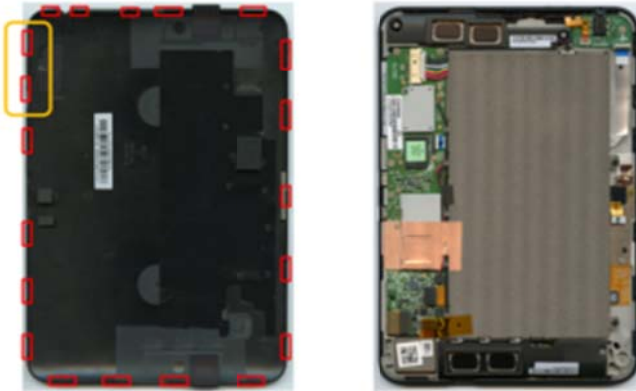

Figure 21: DUT_10 opening mechanism

DUT_04 has basically the same opening mechanism including 18 clips of 3 different sizes. Negative is the fact that some of the clips attach from the outside and some from the inside. Due to these design the leverage with the spattle needs to be carefully applied (Figure 22).

Step 1: Removal of back-cover

18 Clips, levered with a metal-spattle, non-destructive except some scratches



Figure 22: DUT_04 opening mechanism

DUT_03 is an example that shows how important it is to know the opening mechanism in advance in order to avoid significant damage to the product. After removing three smaller covers by loosening four screws the back-cover could be open with a metal-spattle (Figure 24)

Steps 1/2: Removal of 3 covers on the slim sides, Loosening of the 4 Screws underneath



Figure 23: DUT_03 opening mechanism

Because the opening mechanism was unknown we ripped a ribbon cable during this step. That could have been avoided if respective information would be available.

Steps 3/4: Removal of back-cover

19 Clips, USB + headphone jack on opposite sides might jam.
Loosening of adhesive (one-sided). Cover must be opened downwards in order to avoid data-/charging-cable to be damaged.

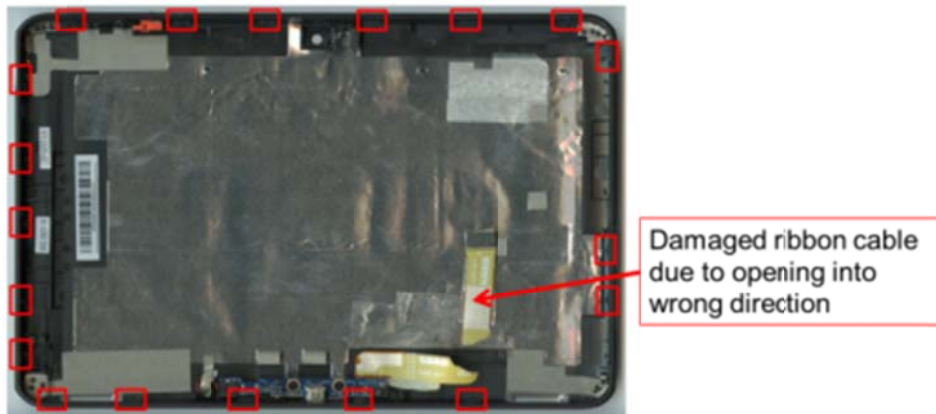

Figure 24: DUT_03 damaged ribbon cable

DUT_09 showed a complex opening mechanism with many steps and also the danger of damaging a cable when finally opened. In order to get to the back-cover a total of six steps were necessary (Figure 25).



Figure 25: DUT_09 removal of speaker cover

The final opening of the DUT_09 was complex and consisted of three additional steps including loosening of tapes and connectors (Figure 26).

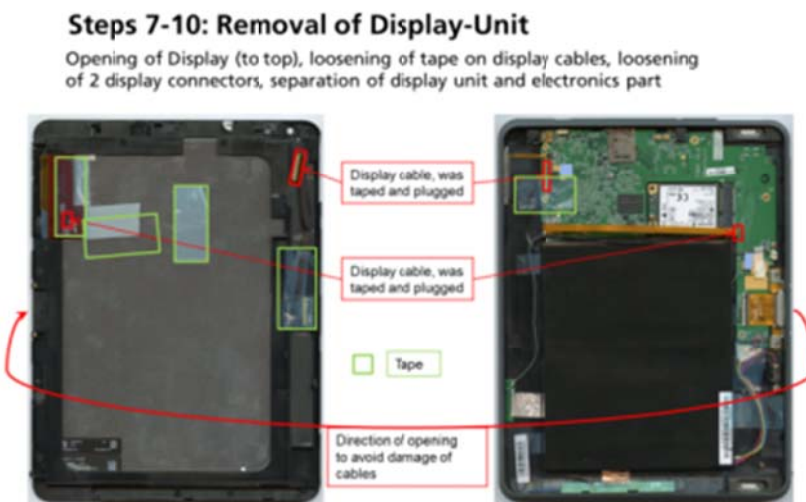

Figure 26: DUT_09 removal of display unit

DUT_02 showed a complex design. Without knowledge of the opening mechanism we damaged first the DUT before we identified that the camera-cover has to be opened first. This cover has been fastened with seven clips and two small adhesive pads (double-sided) on the backside, furthermore bent over on the upper edge to the front of the device, where it is heavily fastened with double-sided adhesive (Figure 27).

Steps 1/2: Removal of charging-cable and camera cover

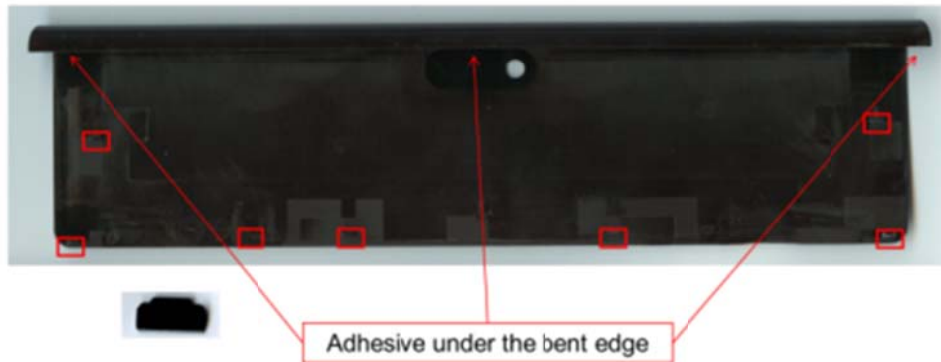

Figure 27: DUT_02 removal of camera cover

The removal of the back-cover in the next steps was rather unproblematic and a combination of ten screws and clips (Figure 28).

Steps 3-5: Loosening of 10 Screws, Removal of back cover

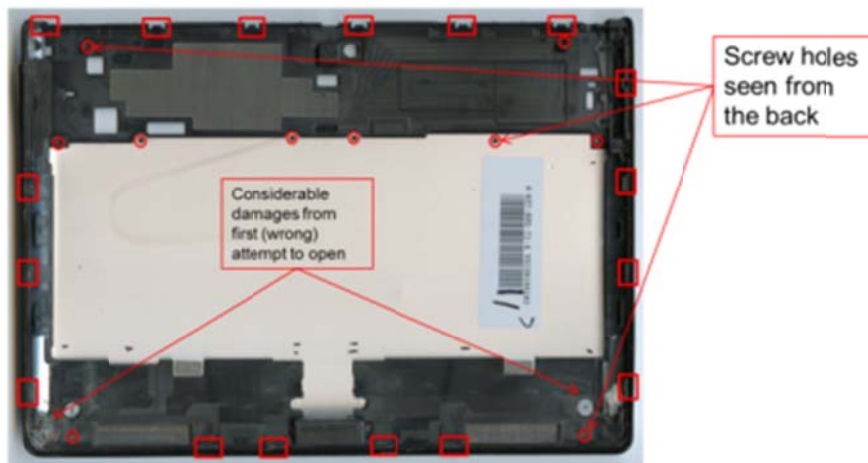

Figure 28: DUT_02 removal of back-cover

DUT_07 is a special case as the display needed to be removed at first. In order to open the display special tools for dissolving the adhesive were required. After heating the adhesive with a hot air gun the tensile strength was still strong and applying leverage demanded considerable force. With respect to a reassembly scenario (change of battery) the remaining adhesive must be removed and renewed (Figure 29).

Step 1: Heating of glass-edges

Very strong double sided adhesive, damages due to powerfull levering, scratches and damaged cable. Glas and display unit are not yet seperated from the rest at this step!

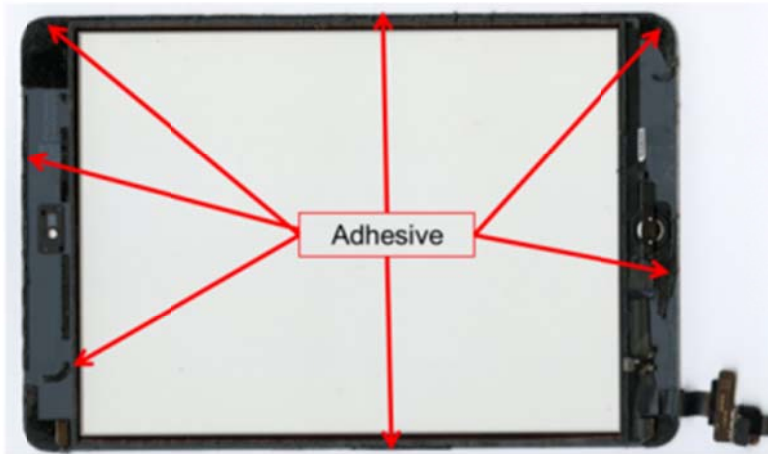

Figure 29: DUT_07 Heating and removal of display

Almost all slates feature axially accessible screws only. The use of radially accessible screws is found only in very few cases.

7 Individual analysis: Removal of battery

7.1 Disassembly data

The second phase of the disassembly test is the removal of the battery. The respective analysis considers mainly the first scenario and evaluates the ease of disassembly, damage inflicted on the DUTs, and possible reassembly capability (reversibility). The disassembly data for second step are shown in [Table 4](#) below.

Main finding with respect to removal of battery:

- One DUT was specifically designed for the exchange of the battery in one step without any tools
- A total of five DUTs used battery connectors that need no manual manipulation (opening with two hands).
- A total of three DUTs used screws only to fix the battery pack in the device.
- The average number of screws used to fixing the battery is four. A total of six DUTs used more than 4 screws to fasten the battery.
- In all other cases (total of 17 DUTs) a combination of screws and adhesives as well as individual screws, clips and adhesives have been utilized.
- One-side adhesive tape is typically used to keep flat-band cables and heat spreaders in place.
- Double sided adhesive tape is typically used to secure the battery pack within the devices (e.g. taped to the back side of the display unit).
- The battery pack is in many cases glued into a thin plastic or metal frame (hull) and then fastened with a few screws to the inner frame of the DUT.
- In some cases even this extra battery frame (hull) is glued into the devices. There is typically no problem in lifting out the glued battery pack. However, it could not be determined if the battery was damaged during this process.
- In three devices the battery wires are soldered onto the board.

DUT	Battery removal									
	Number of used tools	Number of special Tools	Different screws	Number of connectors	Number of screws	Number of clips	Adhesive (one-sided) in cm ²	Adhesive (two-sided) in cm ²	Adhesive (two-sided, heat) in cm ²	Number of steps
DUT_01	1	0	1	5	10	0	26	0	0	6
DUT_02	1	0	1	3	4	0	2	0	0	5
DUT_03	1	0	2	2	3	0	36	0	0	8
DUT_04	1	1	0	1	0	0	24	6	0	4
DUT_05	1	0	0	1	0	0	7	0	0	2
DUT_06	1	0	1	1	15	0	0	0	0	4
DUT_07	2	1	0	1	0	0	0	0	16	3
DUT_08	2	0	2	3	8	0	19	0	0	7
DUT_09	2	0	0	3	0	0	18	21	0	7
DUT_10	2	0	2	1	5	0	11	0	0	6
DUT_11	2	0	8	0	11	0	15	11	0	9
DUT_12	3	0	2	9	7	0	1	39	0	9
DUT_13	2	0	1	3	4	0	7	0	0	5
DUT_14	1	0	0	0	4	0	0	0	0	2
DUT_15	1	0	0	1	0	0	0	29	0	2
DUT_16	2	1	0	0	0	0	17	23	0	3
DUT_17	1	1	0	0	0	0	82	14	0	3
DUT_18	1	0	0	4	12	0	15	0	0	4
DUT_19	1	0	1	1	6	0	0	0	0	3
DUT_20	1	0	1	1	9	0	5	0	0	6
DUT_21	0	0	0	0	0	0	0	0	0	2
mean value	1	0	1	2	5	0	14	7	1	5
min value	0	0	0	0	0	0	0	0	0	2
max value	3	1	8	9	15	0	82	39	16	9

Table 4: Disassembly data removal of battery

7.2 Analysis of individual product designs

DUT_21: This product is directly designed for the exchange of the battery in one step and without any tools. A mechanical spring-loaded slider functions as the locking mechanism and secures the battery in the devices. The battery is directly attached to outer cover. The locking mechanism in itself seems to be robust and has a small form factor (Figure 30).

DUT_21: Removal of battery



Figure 30: DUT_21 Removal of battery

DUT_14: This is a positive example where the opening of the device (clips only) and the removal of battery was easy to achieve. The battery pack is fastened to the inner frame with a total of four screws. The battery was slipped into a socket connector without the need to manipulate the connector (Figure 31).

DUT_14 battery removal: loosening 4 screws / battery slipped into socket connector

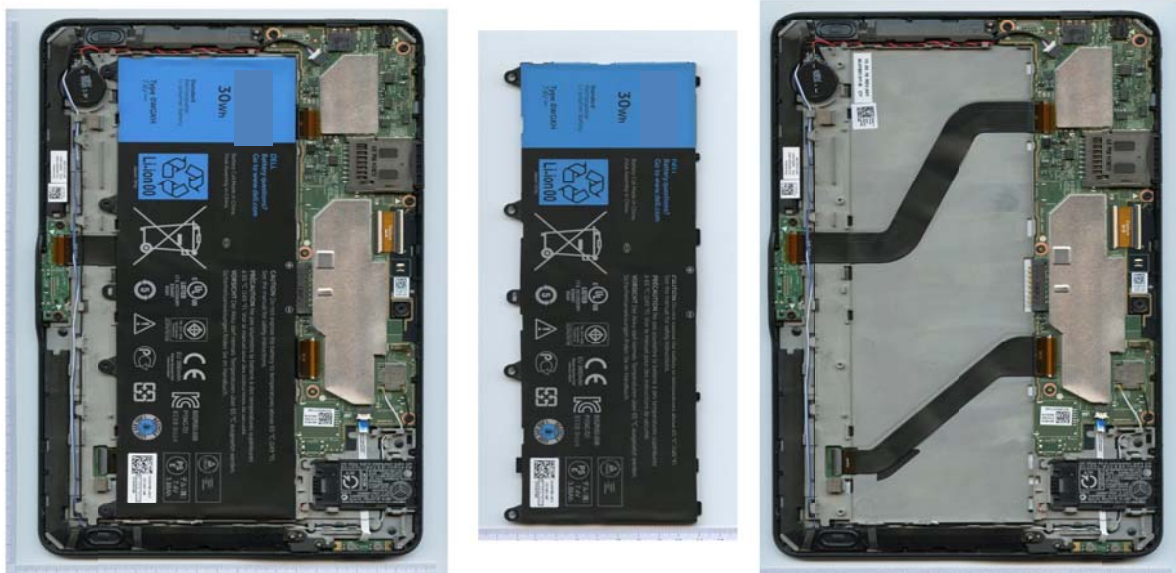

Figure 31: DUT_14 removal of battery

DUT_19: This DUT is another positive example. Fixed by 6 screws and a simple connector, the battery could be removed and replaced within a few seconds (see [Figure 32](#)).

DUT_19 battery removal: loosening 6 screws / battery attached through connector

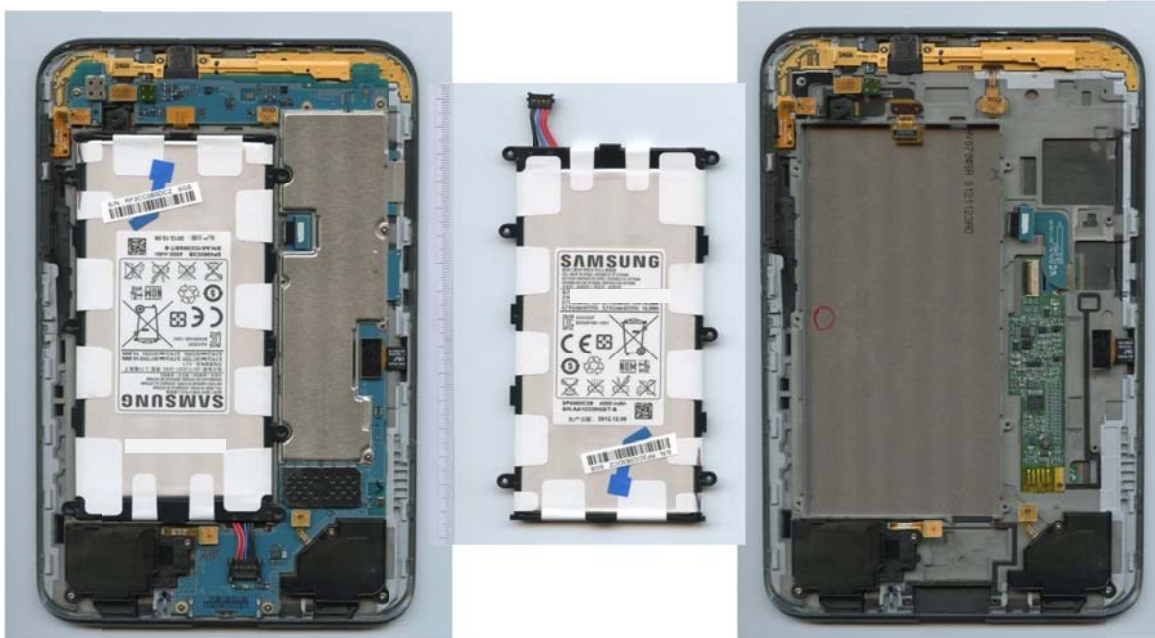

Figure 32: DUT_19 removal of battery

DUT_05: In this case the removal of the battery was quite easy, too. In total only two narrow double-sided adhesive tapes needed to be removed in order to lift off the battery and unplug the battery connector. The implementation of two-sided adhesive tape proved being a good option for the battery as it was adequately functional and featured a little trick. Applied to the bottom side of the battery pack with a small overlapping non-adhesive end the adhesive could be easily pulled off in order to remove the battery (see [Figure 33.](#))

Step 3: Removal of battery

2 narrow double-sided adhesive tapes are to be removed

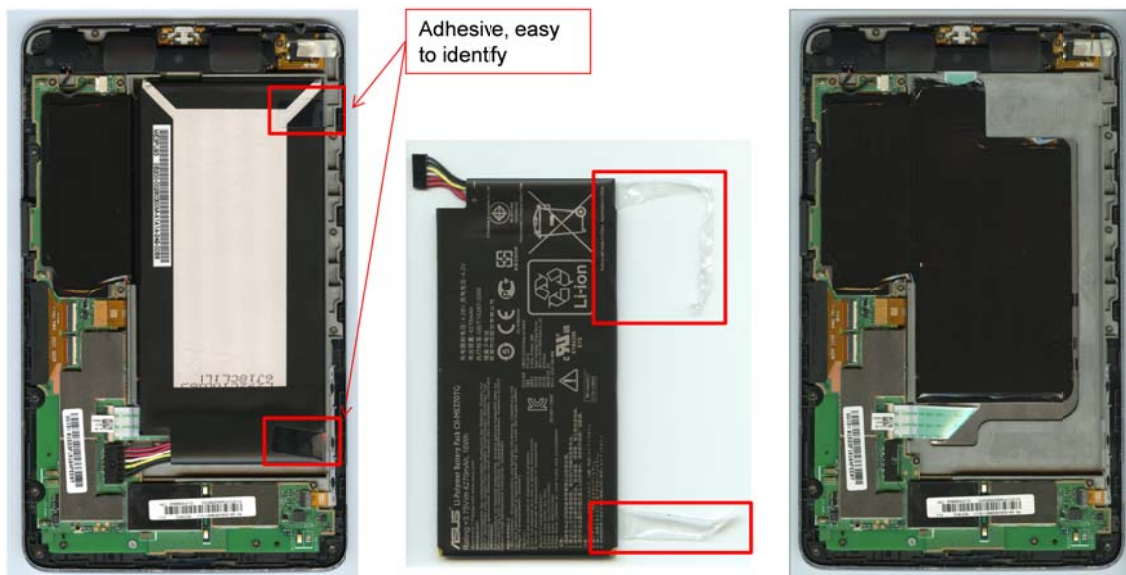

Figure 33: DUT_05 removal of battery

DUT_06: This DUT featured a design that was more work intensive but still easy to dismantle and reassemble. The removal of the battery was possible by taking off the inner frame which was fastened by 15 screws (Figure 34).

Step 2-4: Loosening of 15 screws to remove frame

One Screw is located under Serial-No.-Label



Figure 34: DUT_06 removing the inner frame

Unplugging the connector and lifting-off the double-sided tape for the removal of the battery (Figure 35).

Step 7/8: Unplugging and removal of battery

Unplugging of battery jack and removal of adhesive tape (double-sided)

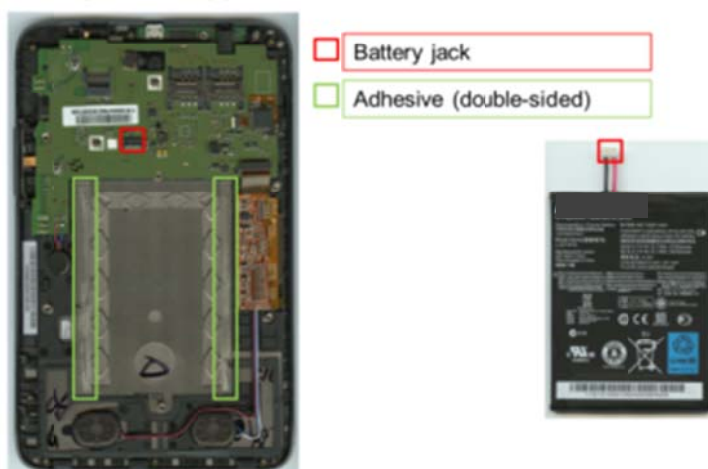
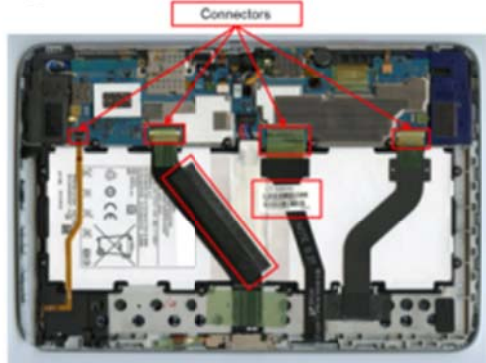

Figure 35: DUT_06 removal of battery

DUT_01: This product is a typical example for the removal of the battery where multiple cables, adhesive tapes and screws need to be loosened in order to unplug the battery (Figure 36). This process is generally reversible.

Steps 4-6: Unplugging of 4 ribbon cables, loosening of 2 adhesives (one-sided)



Steps 7-9: Loosening of 10 screws and unplugging of battery connector, removal of battery

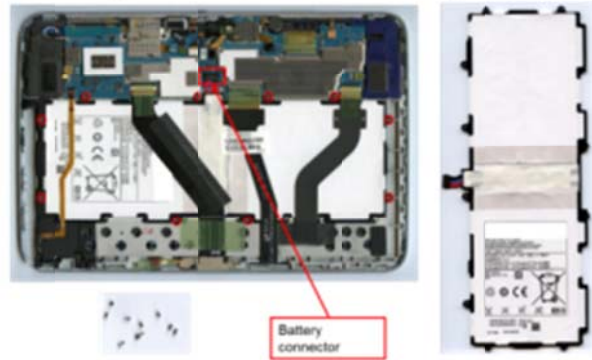

Figure 36: DUT_01 removing the battery

Similar products are **DUT_02** and **DUT_09** (Figure 37).

Step 13: Removing of battery
Double sided adhesive under battery



Steps 6-10: Loosening of 2 ribbon cable connectors, adhesive tape on temperature sensor, battery jack and 4 Screws. Removal of battery.

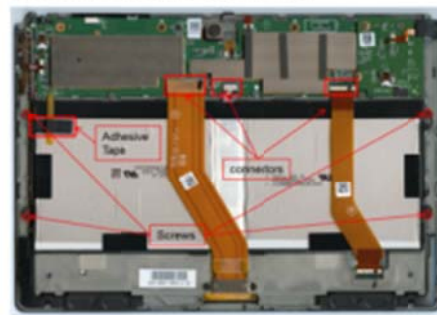

Figure 37: DUT_09 (left) and DUT_02 (right) removing the battery

DUT_03 and DUT_08 show a larger amount of different adhesive tapes that need to be removed before getting access to the battery. The battery removal in itself is quite simple.

Steps 5-10: Loosening of 7 adhesive tapes (one-sided) and 3 Screws



Figure 38: DUT_03 removal of battery

In the case of DUT_08 a warranty seal needs to be cut (Figure 39).

Step 3-7: Removal of 7 different stickers (metal mesh, rubber, tape) 1 broken warranty-seal, loosening of 3 connectors and 8 screws

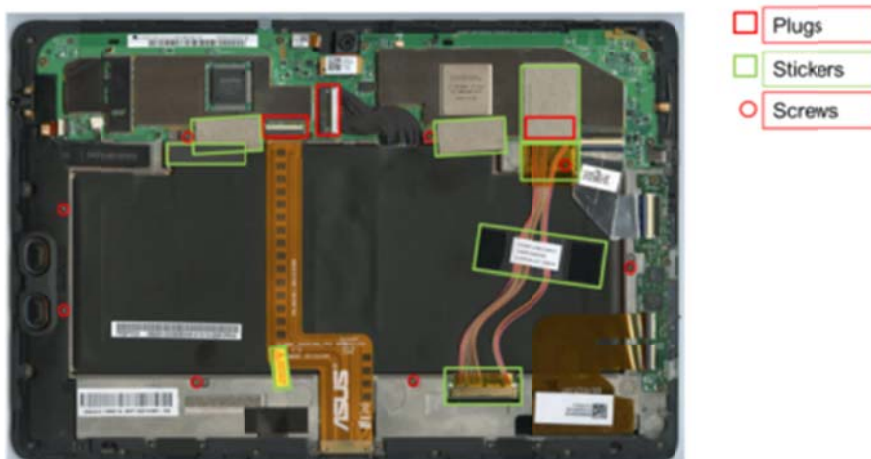

Figure 39: DUT_08 removal of battery

DUT_07: In order to remove the large aluminum shield a total of 23 screws needed to be removed. This total amount included four different types of screws with two different screws drivers. These four different types of screws make it necessary to document or know the exact location of each screw for an optional reassembly (Figure 40).

Steps 2-7: Loosening of 4 screws, opening of display-unit, Loosening of 19 screws, Removal of 2 metal covers



Figure 40: DUT_07 removal of metal shield

The battery connector, the display connector and a connector to the front panel needed to be disconnected. This was unproblematic. The two adhesive tape strips that keep the battery in place are very strong (Figure 41).

Steps 11-13: Removing of battery

Heating the backside with heat gun to loosen the adhesive (very strong), lever battery with wide and even spatel

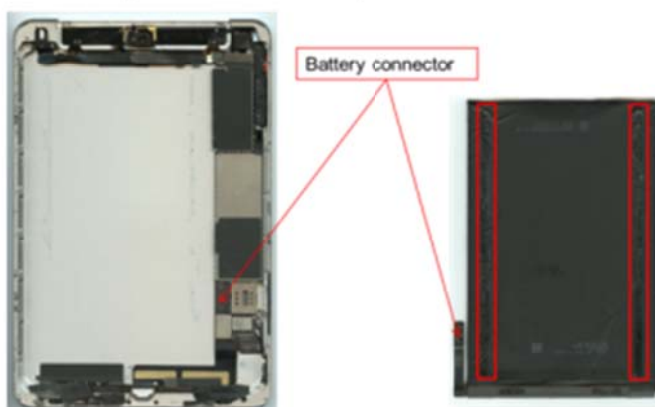

Figure 41: DUT_07 removal of battery

DUT_10 shows a few problematic design features. First of all, a special torx screw driver required in order to loosen five screws. A copper tape must be cut which is problematic with respect to the change of battery scenario (Figure 42).

Steps 2-4: Loosening of 5 screws and 3 adhesive tapes

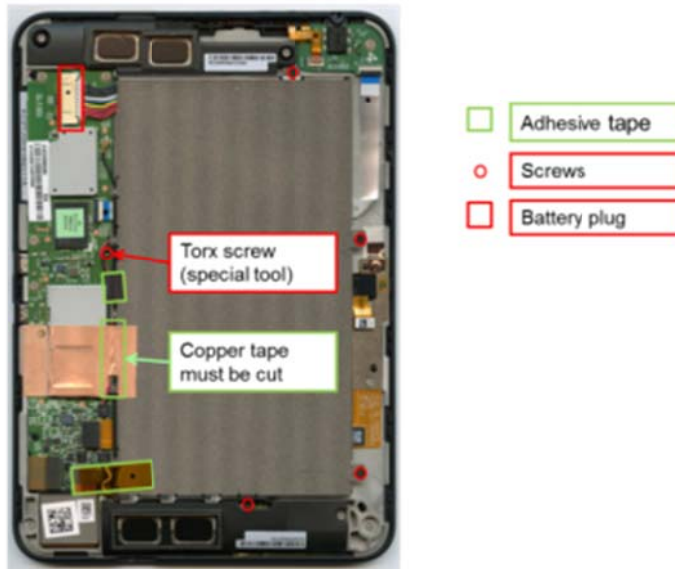

Figure 42: DUT_10 torx screws and problematic tapes

A considerable difficulty with respect to the change of battery scenario is also a cable that is placed around the battery pack (Figure 43).

Steps 5-7: Removing of battery

Unplugging of battery, hooked cables around battery have to be removed

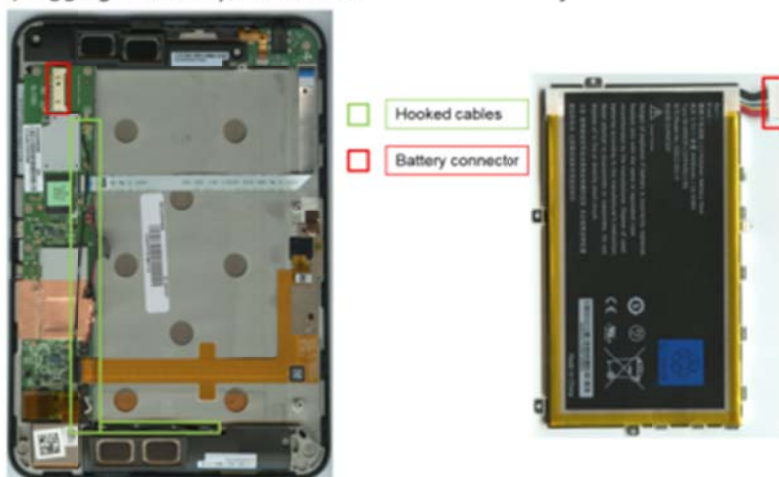

Figure 43: DUT_10 unplugging the battery

DUT_04 showed a very simple design using a lot of one-sided adhesive tape (Figure 44).

Steps 2/3: Removal of 3 adhesive tapes (one-sided), loosening of ribbon cable connector

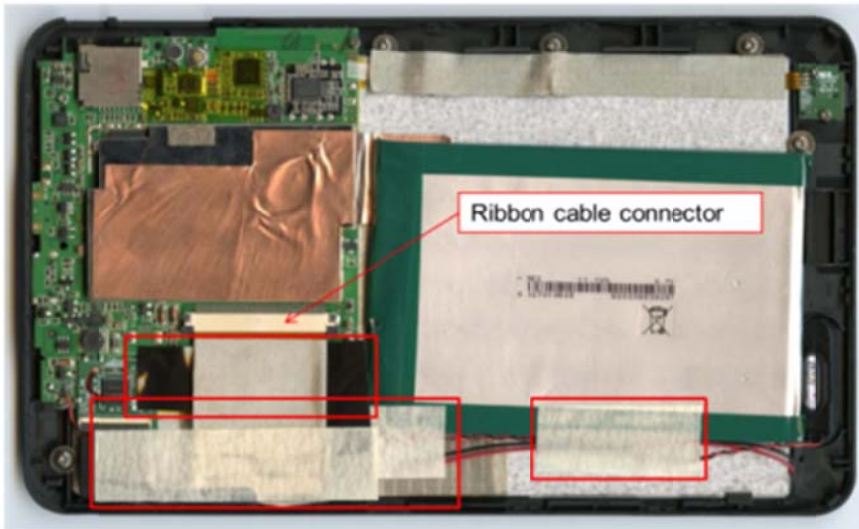

Figure 44: DUT_04 adhesive tapes

In comparison to all the other DUTs from the 1st batch only DUT_04 featured a battery connection that was soldered (Figure 45).

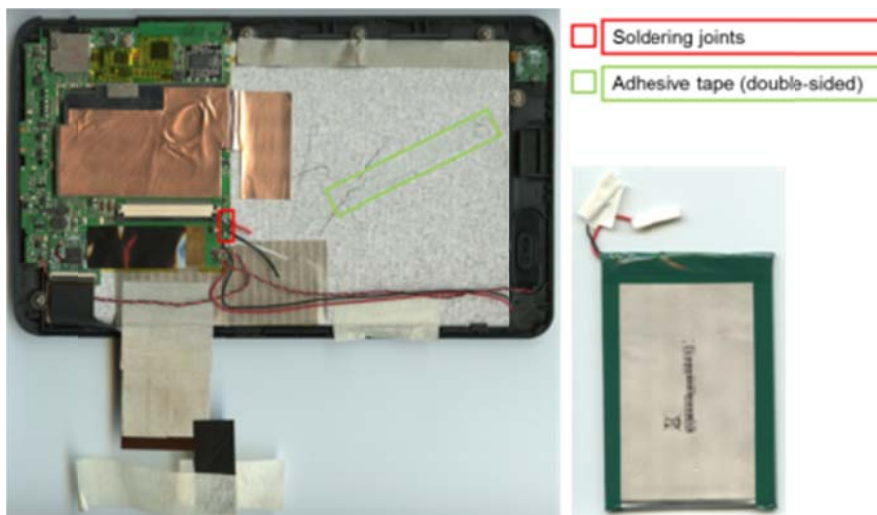

Figure 45: DUT_04 soldered battery pack

8 Individual analysis: Dismantling of mainboard

8.1 Disassembly data

The [Table 5](#) below provides a quantitative overview of all relevant data with respect to the dismantling of the mainboard. As a general observation, the dismantling of the mainboard is a delicate work, requires multiple steps, and is therefore time-intensive.

Main findings:

- The average number of steps for dismantling the mainboard is ten but there are a few DUTs that required many more steps (the maximum was 46 steps). The steps include the detaching of various types of tape, loosening of screws, and unplugging various types of connectors.
- In general many small parts such as camera covers, speakers, card reader slots, microphone, wireless interfaces, and thermal shields or patches have to be unscrewed or separated before the mainboard could be detached.
- The average number of connectors that need to be detached is seven. The maximum has been 12 and the minimum only one. The connectors are not only situated on the topside of the mainboard (visible and therefore quite easy to disconnect) but also on the bottom side (less visible and more difficult to disconnect).
- The mainboard is in most cases screws to the frame. Three DUTs use plastic self-tapping screws, which could provide problems in a refurbishment scenario (reversibility)
- Only in two cases was the mainboard glued (but relatively easy to separate).

DUT	Mainboard removal									
	Number of used tools	Number of special Tools	Different screws	Number of connectors	Number of screws	Number of clips	Adhesive (one-sided) in cm ²	Adhesive (two-sided) in cm ²	Adhesive (two-sided, heat) in cm ²	Number of steps
DUT_01	2	0	1	17	4	0	12	2	0	17
DUT_02	3	0	2	9	4	0	2	0	0	12
DUT_03	2	0	2	13	6	2	47	1	0	15
DUT_04	2	1	1	2	5	0	41	2	0	10
DUT_05	2	0	3	7	13	0	53	0	0	8
DUT_06	3	0	1	4	16	0	1	20	0	13
DUT_07	4	0	7	10	23	0	15	17	0	44
DUT_08	3	0	2	8	7	5	0	21	0	15
DUT_09	4	0	1	9	7	0	21	22	0	19
DUT_10	3	0	2	8	6	0	16	0	0	15
DUT_11	1	0	2	9	11	0	15	0	0	8
DUT_12	3	0	2	9	7	0	1	7	0	8
DUT_13	2	0	0	7	6	0	0	7	0	6
DUT_14	2	0	2	9	11	0	0	0	0	11
DUT_15	2	0	2	7	7	2	6	0	0	10
DUT_16	2	1	1	1	3	0	31	0	0	7
DUT_17	2	1	1	3	7	0	147	0	0	8
DUT_18	1	0	1	12	1	0	16	0	0	6
DUT_19	1	0	1	10	6	0	0	0	0	4
DUT_20	1	0	0	8	6	0	9	0	0	9
DUT_21	1	0	2	11	6	0	0	0	0	4
mean value	2	0	2	8	8	0	21	5	0	12
min value	1	0	0	1	1	0	0	0	0	4
max value	4	1	7	17	23	5	147	22	0	44

Table 5: Dismantling data mainboard

Data in Table 5 includes only the process steps once the device is opened.

8.2 Analysis of individual product designs

DUT_19 features a very simple and straight forward design for dismantling the mainboard. In total only three steps were needed. The first step was to unplug

nine connectors (no problem because they were all visible and easy to detect). Then we had to unscrew six screws and detach the mainboard. This was a little bit tricky because the mainboard needs to be pressed away from the charger jack (see [Figure 46: DUT_19 dismantling of mainboard](#)).

DUT_19 mainboard removal: loosening of 9 connectors / loosening of 6 screws



Figure 46: DUT_19 dismantling of mainboard

DUT_13 shows a similar good design. The mainboard could be dismantled in three basic steps. First, we had to unplug five connectors and then loosening six screws. At that point we could detach the mainboard and separate further components such as front and back camera, microphone and EMI shields (see [Figure 47](#)).

DUT_13 mainboard: loosening of 5 connectors/ loosening of 6 screws

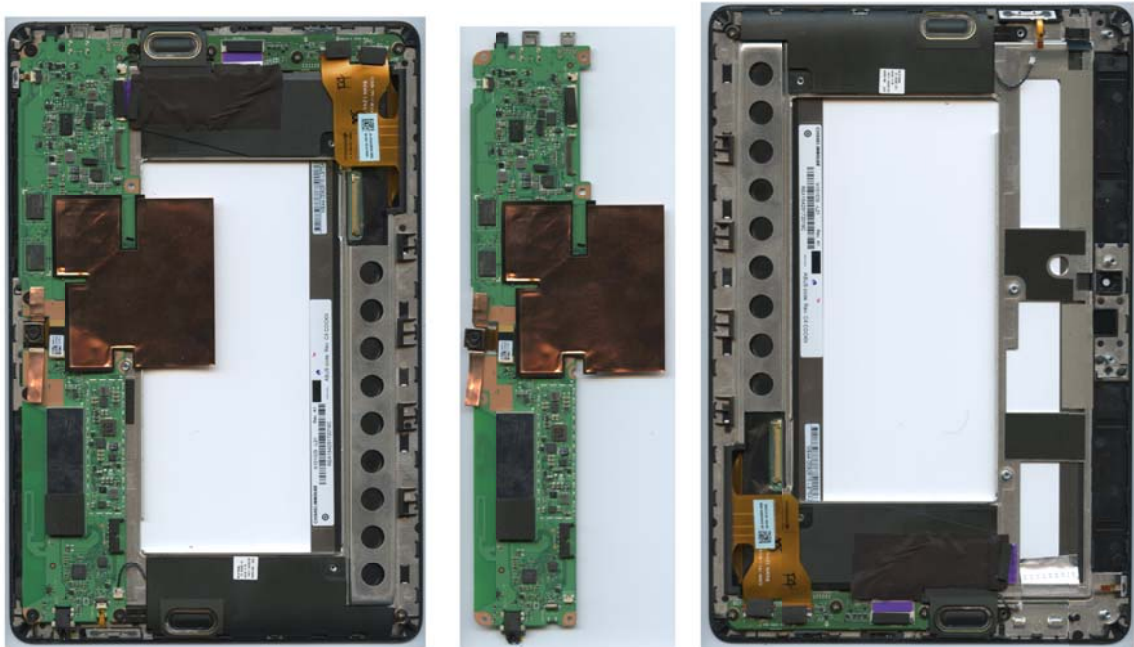

Figure 47: DUT_13 dismantling of mainboard

DUT_20 is another positive example for easy dismantling of the mainboard. The first step was loosening some smaller patches of one-sided tape which fixed e.g. a connector and antenna cable. The delicate part was to unhook the antennas and speakers before unscrewing the mainboard which was fixed with 6 screws (see [Figure 48](#)).

DUT_20 mainboard removal: loosening adhesive tapes/ loosening of 7 connectors/
loosening of 6 screws

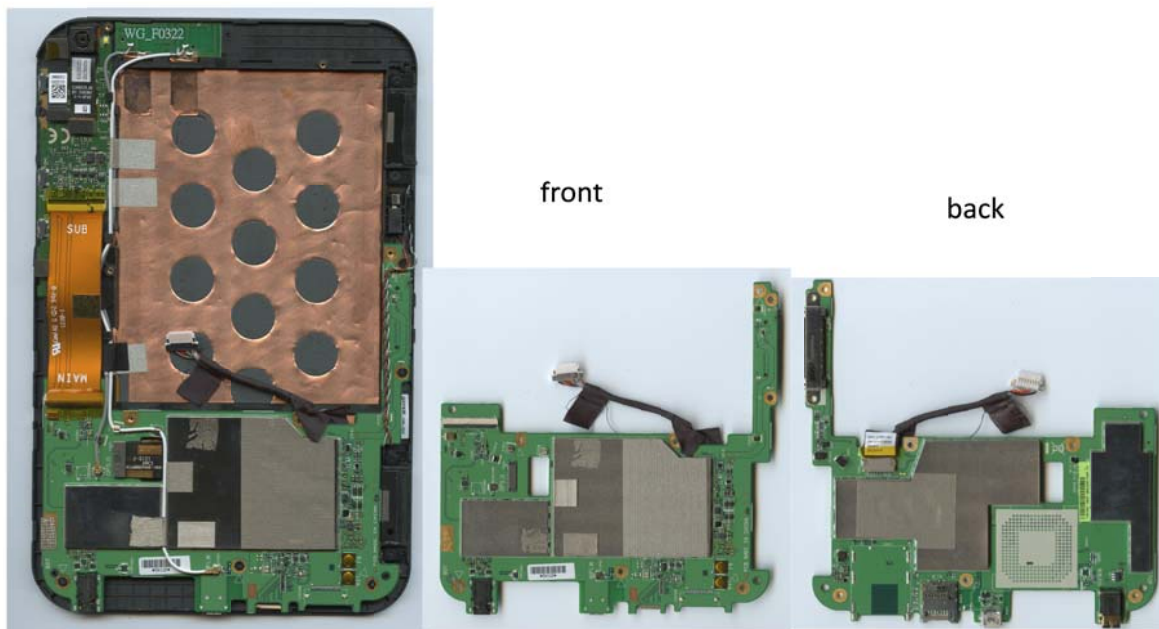

Figure 48: DUT_20 dismantling of mainboard

DUT_16 is similar to DUT_20 with respect to the steps that are required to dismantle the mainboard. DUT_16 and DUT_06 featured the smallest number of screws (3 and 2) for fixing the mainboard. In comparison to DUT_20 the DUT_16 used two types of screws and more adhesive tape (see [Figure 49](#)).

DUT_16 mainboard removal: loosening adhesive tapes/ loosening of connector/
loosening of 3 screws



Figure 49: DUT_16 dismantling of mainboard

DUT_02 features a somewhat more complex design. The problem was the use of two types of screws (Philips 0 and Philips 00) which required a tool change (see [Figure 50](#)).

DUT_02 mainboard removal: loosening of adhesive tapes/ loosening of 6 connectors/
loosening of 4 screws/ loosening of one other component

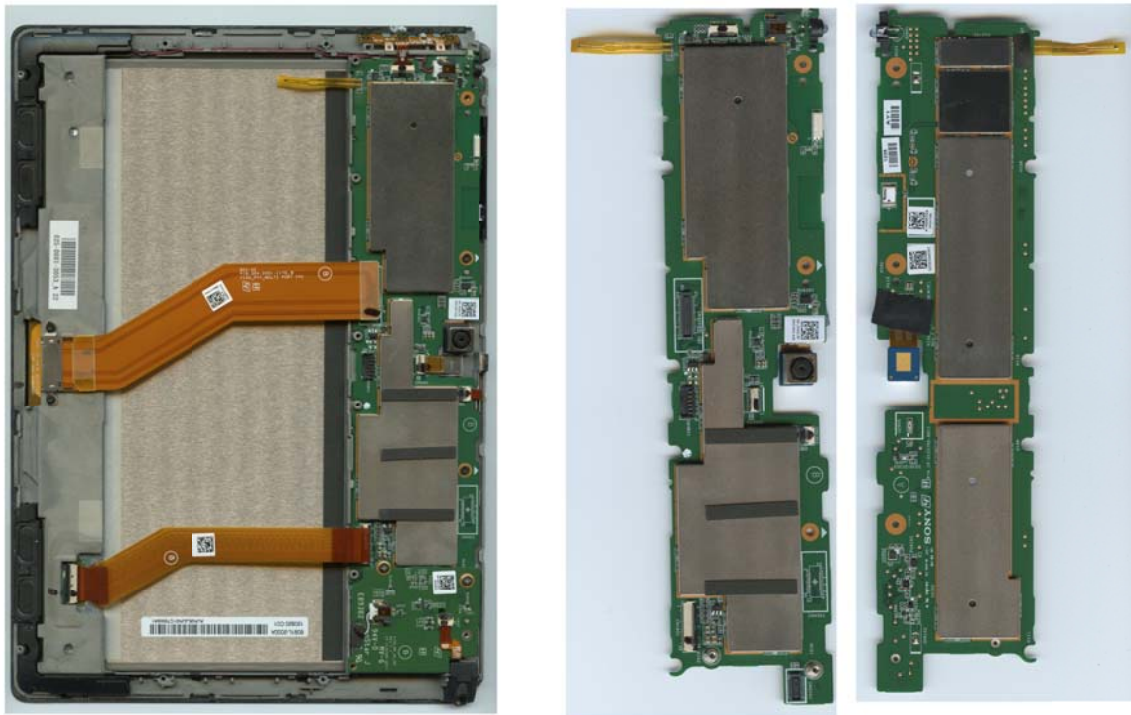

Figure 50: DUT_02 dismantling of mainboard

DUT_15 shows again a more complex design. In total nine steps were necessary to detach the mainboard. Frequent tool change due to three different types of screws including a TORX increased the complexity of the process slightly (see [Figure 51](#)).

DUT_15 mainboard removal: loosening of 2 Clips/ loosening of 9 screws/ adhesive tapes/ loosening of 6 connectors/ loosening of different components



Figure 51: DUT_15 dismantling of mainboard

Access to specific metal parts - EMI shields

EMI shields are of interest as they represent a significant amount of metal in slates. The following Table 6 provides information concerning the weight and size of the dismantled main boards as well as weight of the mainboards with and without the EMI shields.

DUT	Display size (In)	DUT Weight (gr)	Typ 1	Weight main board w/o EMI (gr)	Weight main board w EMI (gr)2	board area (cm ²)
DUT_04	7,0	333,0	Mainboard	28,0	34,6	70,5
DUT_05	7,0	338,1	Mainboard	29,5	35,9	84,5
DUT_06	7,0	406,9	Mainboard	25,4	34,7	63,0
DUT_10	7,0	387,9	Mainboard	16,8	18,9	45,0
DUT_07	7,9	311,5	Mainboard	16,0	23,0	37,8
DUT_02	9,4	554,0	Mainboard	27,7	40,2	77,5
DUT_09	9,7	665,2	Mainboard	44,5	52,7	127,8
DUT_01	10,1	604,2	Mainboard	30,8	42,0	86,0
DUT_03	10,1	700,7	Mainboard	32,7	41,1	57,0
DUT_08	10,1	638,7	Mainboard	36,4	47,4	103,2

Table 6: DUTs 1st batch data main board

As they are attached to the mainboard, there is the risk that these metal parts end up in the printed circuit board recycling process, where ferro-based materials cannot be recovered and are lost.

Three typical connection types of EMI-shields have been identified.

The first type uses screws to connect the EMI shields (see [Figure 52](#)). This provides a very solid connection and takes considerable time to disassemble.

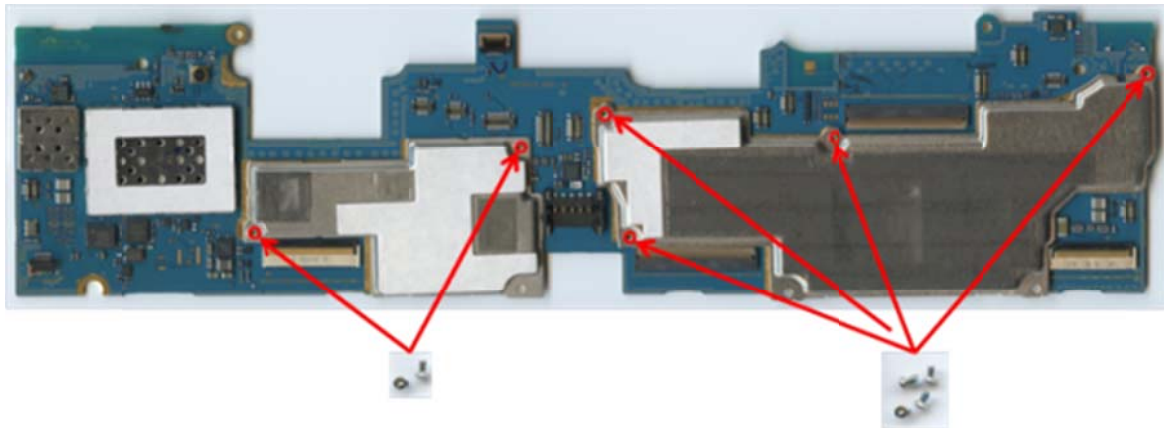

Figure 52: DUT_01 EMI shields connected with screws

The second type is clipped-on EMI-shields (see [Figure 53](#)). This method provides still a quite robust connection and at the same time can be easily separated – manually or mechanically – in a recycling process.

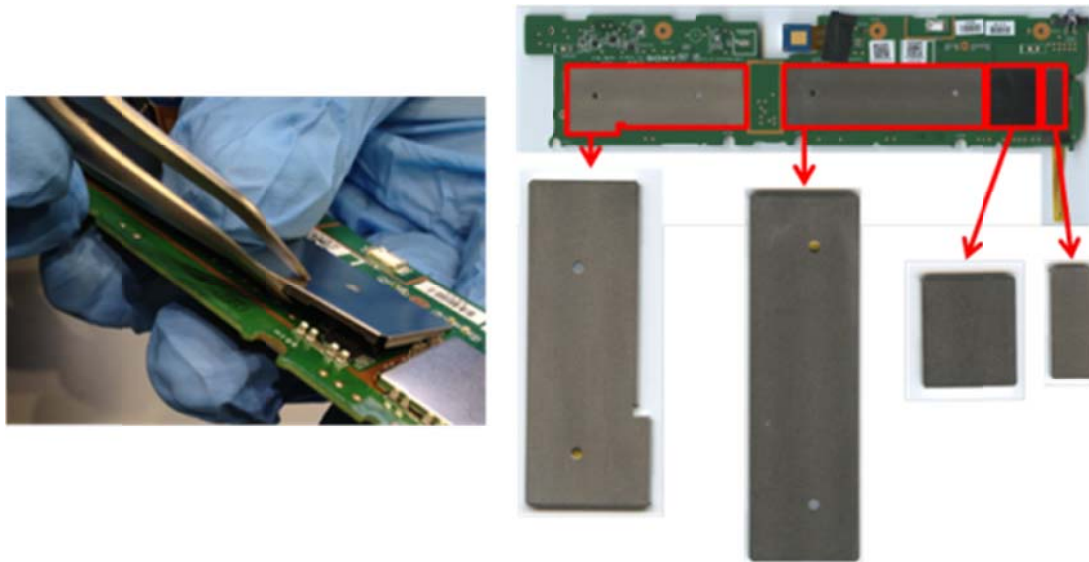

Figure 53: DUT_02 Clipped-on EMI-shields

The third type is a variation of the second type. In these cases a metal (copper) coated adhesive tape not only secures the clipped-on EMI-shield in place, but also functions as a heat spreader (see [Figure 54](#)). This type of fixing the EMI-shield has been observed in various, mostly low cost product cases. The disassembly of the adhesive tape is problematic and sub-optimal in a repair scenario. The handling in a mechanical recycling process needs further investigation.

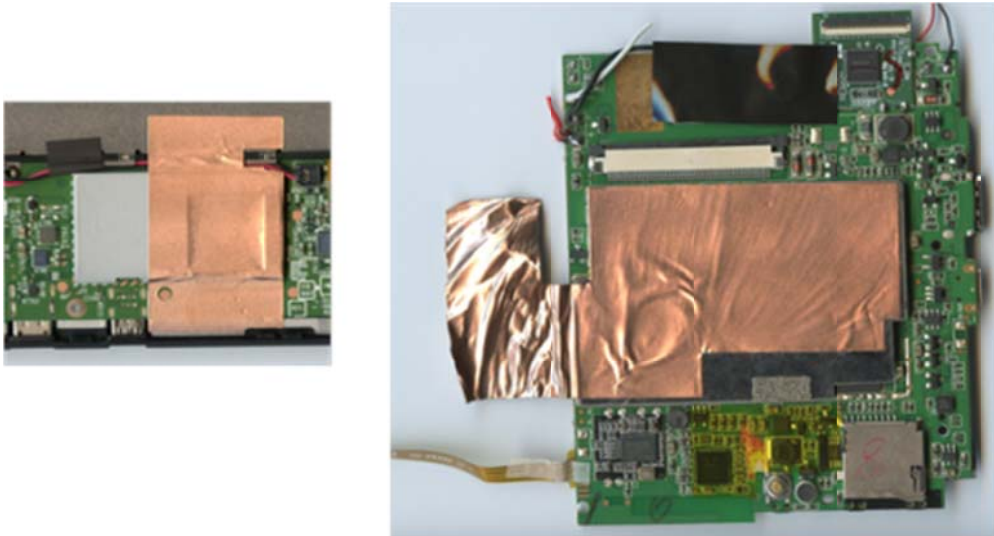

Figure 54: DUT_10 (left) and DUT_04 (right) with EMI-shields fixed with adhesive tape

9 Individual analysis: Dismantling of remaining parts

9.1 Disassembly of the display module

The disassembly of the display unit is relevant task particularly for the repair scenario. After unintentionally dropping a device, a fracture of the display glass is a typical result. In this case an exchange of the display module could be an option in order to extend the lifetime of the product.

A distinction has to be made (but was not part of the analysis), whether a “typical” drop of the unit results in a breaking display unit or of the front glass (touch panel) only. In the latter case easy separation of the front glass from the display module significantly reduces the need to replace the whole LCD unit.

The display module contains:

- the front glass touch panel,
- the LCD panel including the glass substrate and polarization filters,
- the backlight LEDs including the rear cover
- the display driver board (a small rigid or flex PCB fixed on the back or side of the display module
- a connection to the mainboard (mostly a flat-band cable with connector)

The dismantling exercise showed that the front glass touch panel and the display panel is always glued together and sometimes additionally enveloped in metallic tape. The display module is furthermore attached (e.g. with glue, screws) to an outer frame or an inner frame. The access to the display module is in general difficult but possible.

One option is to separate the front glass from the actual display panel by using heat to dissolve the glue that holds the two panels together. This approach was not only an option but the necessary way to open the DUT_07 and DUT_12 (see description of the disassembly process further below). The design of these two products allowed the dismantling of the display module in a relative short time and if carefully done without major damage. The problem on the one hand is the two small cables connecting the display to the mainboard. If not known in advance, these cables could get ripped. On the other hand, it was

only necessary to detach these two cables at their connectors as well as four screws that connected the display panel to the aluminum rear case.

In comparison to all other DUTs, where the display module was approached from the back side and following the removal of the battery and mainboard, it was not necessary to unscrew, unclip, or detach in some kind of way a lot of tiny subcomponents. As a general observation the access to the display module from the back side requires a lot of steps (on average 10 to 30 steps). In most cases all subcomponents (speakers, card reader, vibration module, etc.) needed to be detached and the display module unscrewed from the inner or outer frame.

Specific results:

As mentioned before, **DUT_07** and **DUT_12** are unique cases which allowed a damage-free separation of the front glass (touch screen) and the LCD panel is the first step of the opening process. [Figure 55](#) shows the separated front glass and the LCD panel with the cable and connectors to the mainboard.

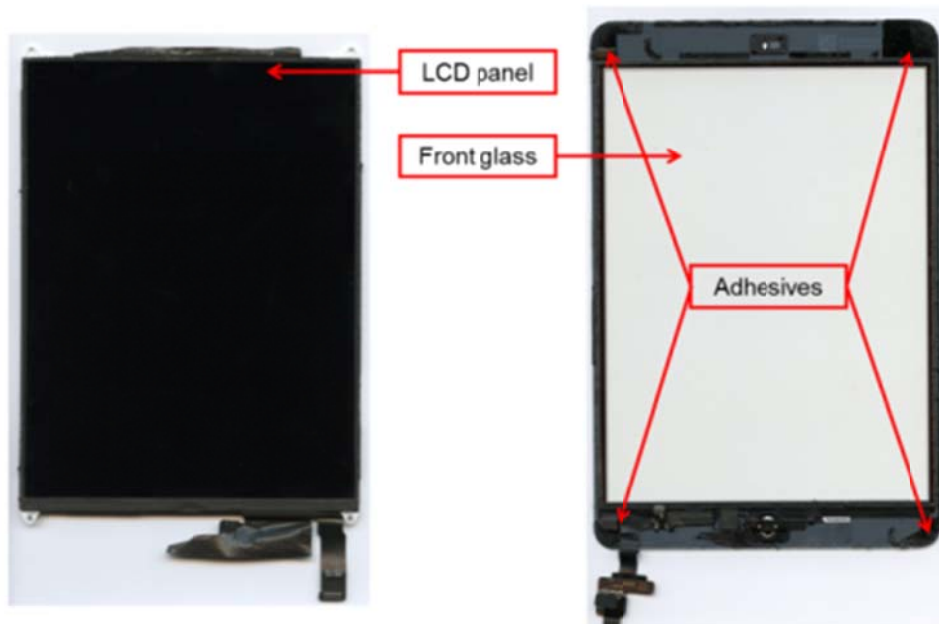

Figure 55: DUT_07 separation of front glass and LCD panel

In the case of DUT_12 the front glass could be quite easily lifted off the LCD panel with a guitar pick after proper heating the sides of the front glass that connect with the aluminum back cover. The front glass needs to be carefully lifted and moved to the left side. Special attention needs to be given to the two

cables connecting the touch screen and power button with the mainboard (see [Figure 56](#)). The glued area is on the outer part of the front glass (where it attaches to the back cover), is about 34 cm² large, and comes off unevenly. The LCD panel and the front glass are separated by a thicker foam material (double-sided tape). That material gets ripped and also comes off unevenly (it would need replacement in a repair scenario).

DUT_12: Separation of the front glass



Figure 56: DUT_12 Separation of front glass

The next step requires unscrewing a total of 4 screws from the front (whereas in the case of all other DUTs the display unit is screwed on from the back side). Then, after disconnecting the display cable at the main board the display unit is completely removed. This connector is secured with a small black tape ([Figure 57](#)). Positive is the fact that there are no smaller components or subassemblies are connected to the display unit that needs to be detached.

DUT_12: Separation of display panel from the device

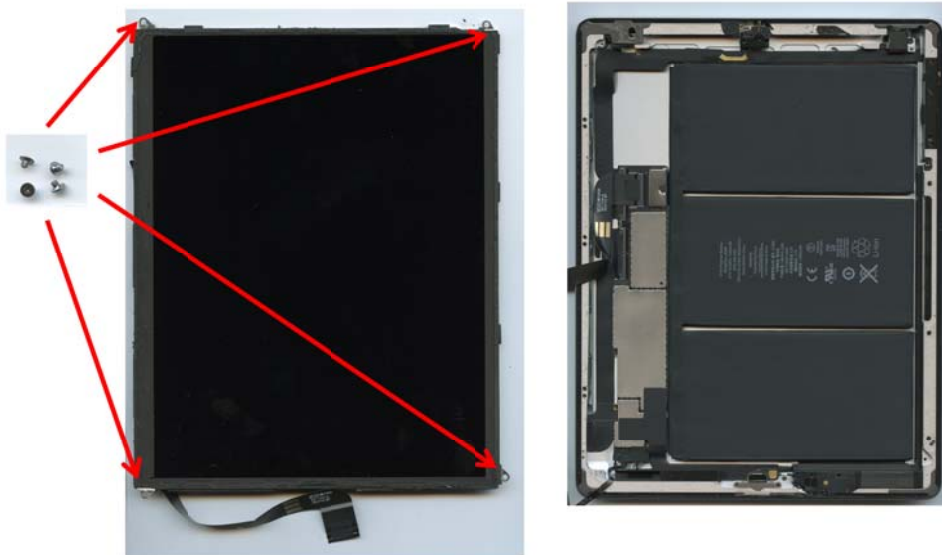

Figure 57: DUT_12 Separation of display panel from the device

In comparison to the design of DUT_07 and DUT_12, where the display unit can be removed from the front, all other DUTs feature a design where the display unit needs to be approached from the rear and after removing the battery, the main board, and other subassemblies.

Note: We made no attempts to open the other DUTs from the front because the designs did not suggest such an approach.

DUT_03 is a typical design example that allows opening the display unit, but does not allow separating the display unit from the front glass. [Figure 58](#) shows front part of the DUT_03 with the display unit. In the right picture we are cutting the plastic studs and copper tapes that are fixing the display unit to the out frame and a metal shield that functions as possible inner frame and thermal barrier. In [Figure 59](#) we are lifting the metal shield off and reveal the back-cover of the display unit.

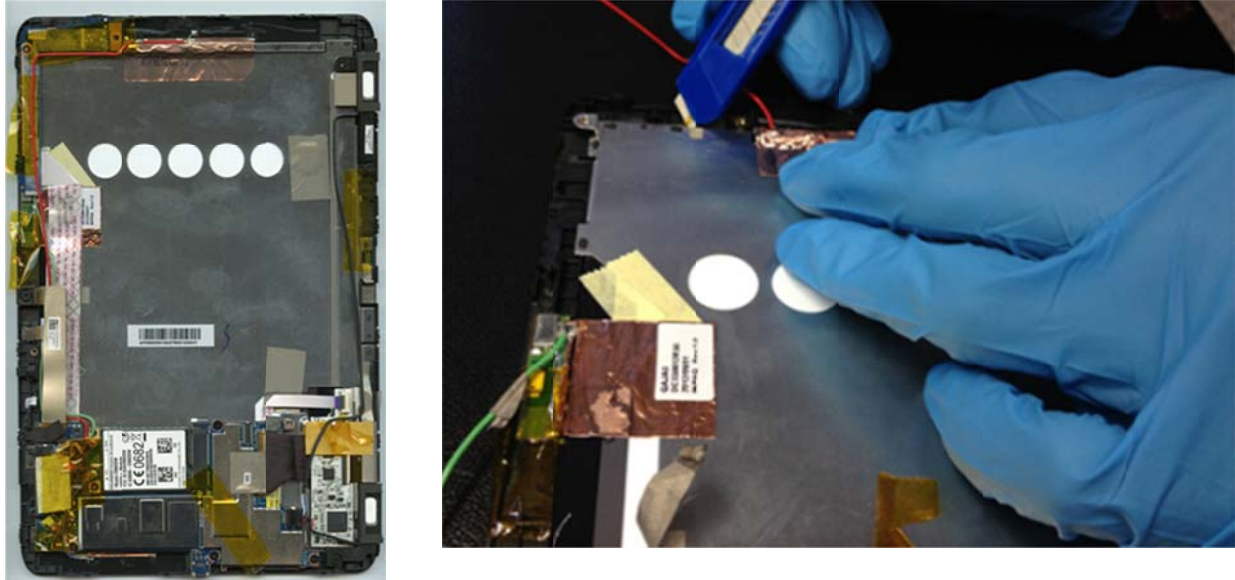

Figure 58: DUT_03 Cutting free the metal shield on the back-side of the display unit

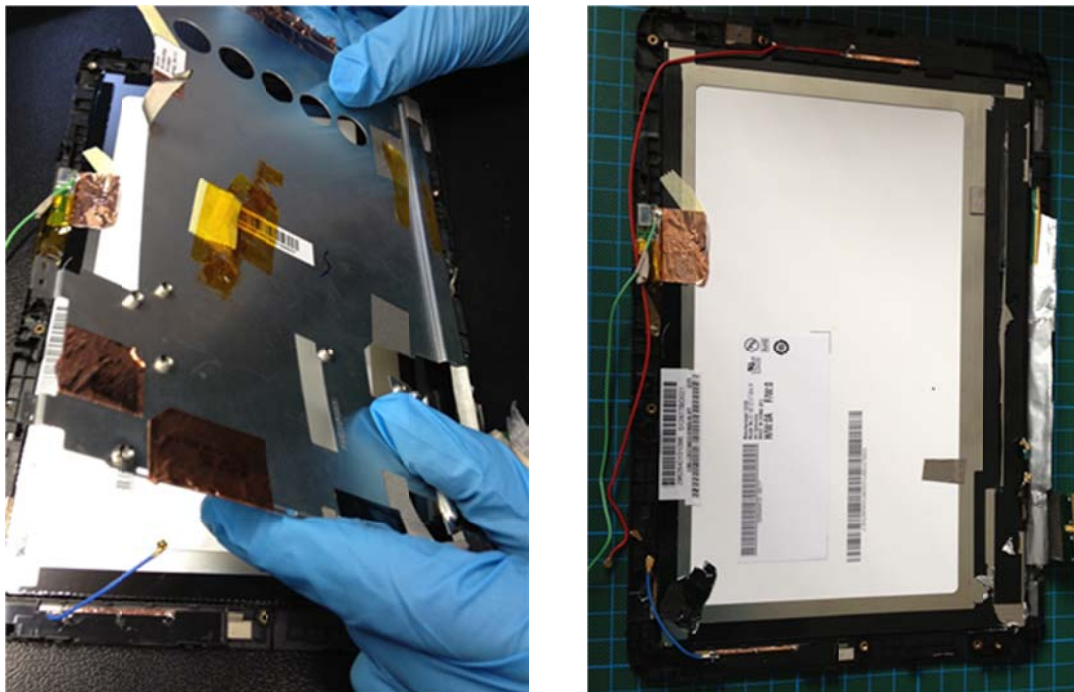

Figure 59: DUT_03 Take away the metal shield

In Figure 60 the display unit is still glued to the front glass but the back-cover of the display unit open revealing the polarizer filter.



Figure 60: DUT_03 Open display unit

DUT_06 is another positive example for a design that allows separating the front glass from the actual display panel as well as from the frame. In comparison to other DUTs was it relatively easy to slip a spatula between front glass and display and separate the glued parts (see [Figure 61](#))

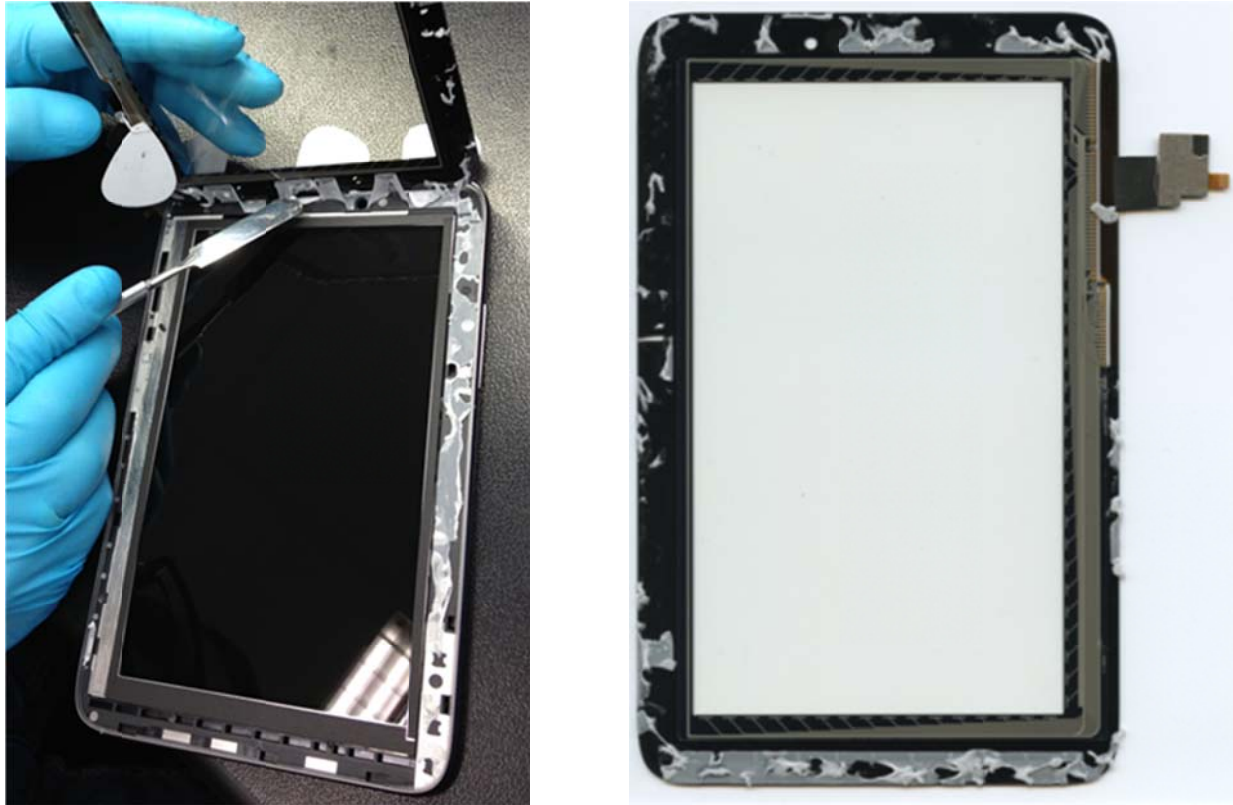

Figure 61: DUT_06 separation of front glass from display unit

While attempting a simple separation of both parts with a spatula the thin front glass broke in various cases. Following [Figure 62](#) shows a failed attempt on the example of **DUT_02**. In the case of DUT_02 it was possible to open the back-cover of the display module including the back-light and polarizers (see [Figure 62](#) left picture), but it was not possible to separate the front-glass from the display panel without complete damage (see [Figure 62](#) right picture).

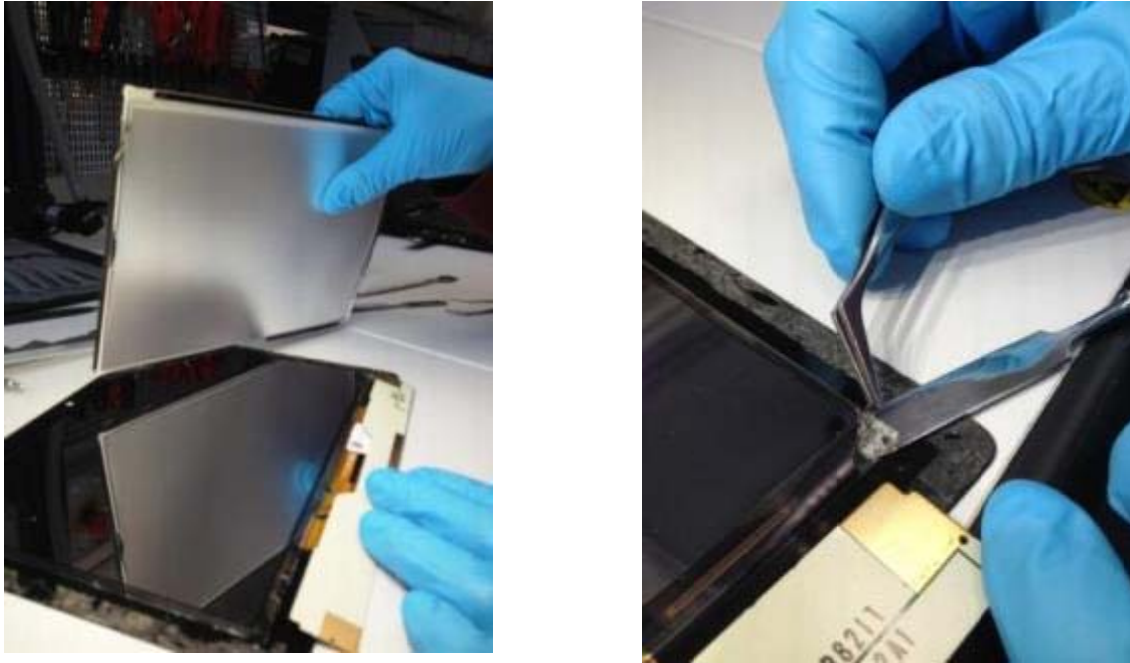

Figure 62: DUT_02 Failed attempt to separate the front glass from LCD panel

The separation of the display driver board required in most cases a cautious removal of protective tape (see [Figure 63](#)). The display driver boards have been rigid PCBs and in two cases flex PCBs.

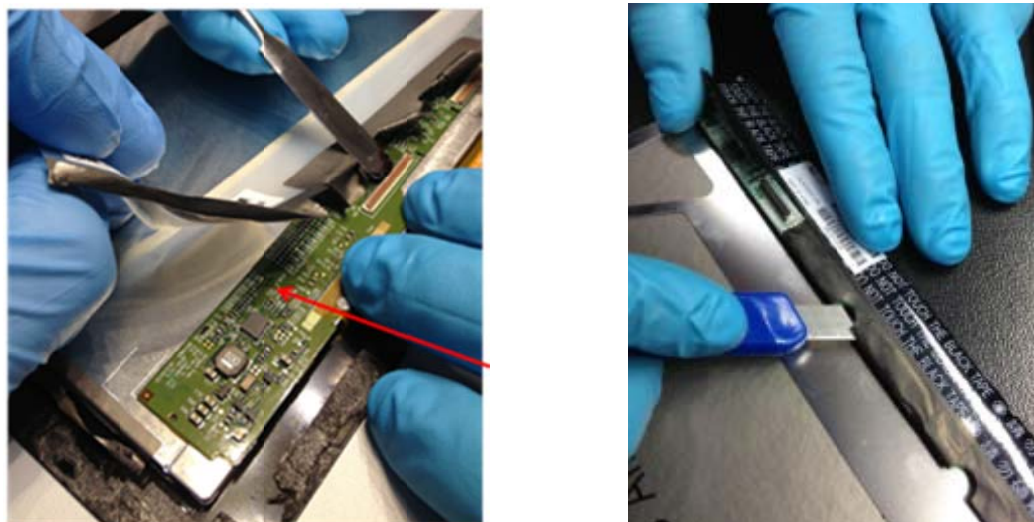

Figure 63: DUT_02 (left) and DUT_01 (right) taped over display driver board

9.2 Dismantling of inner frame

Some of the DUTs featured an inner frame made from magnesium. The final disassembly of the inner frame requires the separation of the display and other smaller parts such as speakers, push buttons or antennas (see Figure 64).

The frame in most cases is a composite material of magnesium and some plastics inserts, which cannot be separated manually.

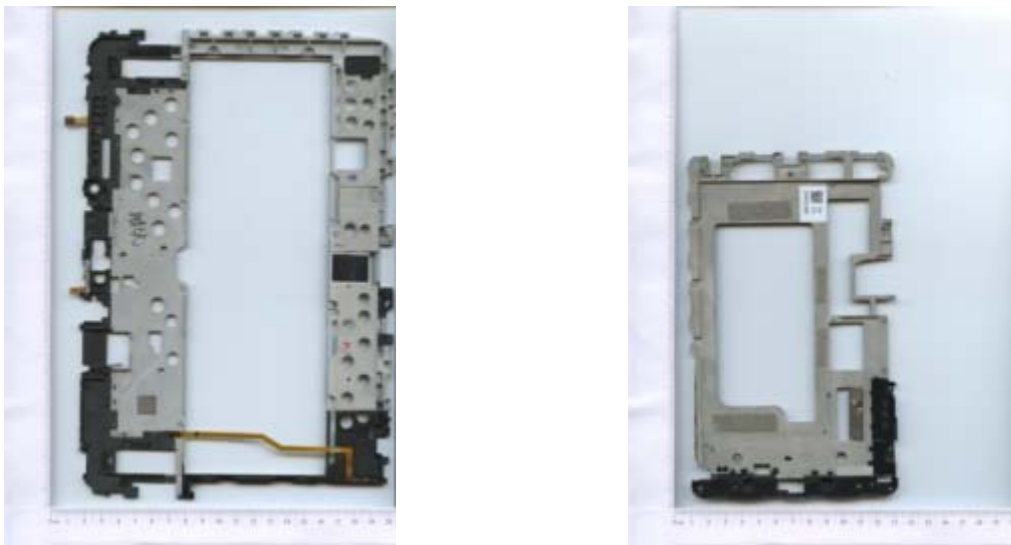

Figure 64: DUT_01 (left) and DUT_05 (right) disassembled frame

A general observation is, that slate designs follow three basic approaches: The required stiffness of the device is either realized through an aluminum housing / back cover (e.g. DUT_07, DUT_11, DUT_12, DUT_17), frequently as a monobody. Those slates with a plastic housing feature frequently the above depicted magnesium frames, and only very few devices (e.g. DUT_09) do not have any larger metal part at all, but a bit stiffer plastics housing.

10 Repair in practice

The interviewed companies (iFixit, San Luis Obispo, California and w-Support.com, Hartmannsdorf, Germany) have long-year experience in the field of disassembly and repair of electronic equipment. The interviews were conducted in November and December, 2013.

In general, the interviewed American and German companies have quite similar observations relating to slates repair, thus they are summarized in the following section. In the case of divergent experience between the companies, this is explicitly mentioned below.

10.1 Repair perspective

It has been stated that products are brought to repair mostly due to the following reasons:

- Breakage of the display due to accidental damage;
- Failure of the battery (for instance, production or electrical failure).

With respect to slates displays a difference between the American and German companies has been observed.

The American repairman points out that in case of display damage mostly only the front glass has been broken, whereas the German company experiences rather the opposite –the damage affects mainly the whole LCD unit and rarely just the front glass.

The damage-free opening is a precondition for repair. Requirements include the easy access to the respective damaged part and the reversibility of the opening. However, it should be mentioned that occasionally clips are on purpose designed not to be simultaneously disengaged because of the robustness of the device in general.

With regard to damage-free and reversible opening, screws are generally preferred over clips. In the case of clips, the reversibility of the opening mostly depends on the clips construction and robustness and not that much on their amount. It has been noted that clips should have such design, which allows their simultaneous disengagement. Otherwise, they are likely to be broken.

The use of adhesives is principally in contradiction to design for repair – for closing the housing as well as for components attachment. The removal of adhesives sometimes requires the use of heating tools, however, adhesives substantially vary with respect to the temperature required to rip them off.

Thus, heating of the device could cause damage of temperature sensitive subassemblies, for instance, some electronic components and the battery.

Based on disassembly and repair of various slates, the following positive features in respect of design for repair have been identified:

- Easy to open and reversible closing mechanism, optimal via several screws. In addition, clips might be used under the condition that they are robust and easy to disengage;
- A modular design, allowing an easy and damage-free removal, as well as substitution of subassemblies, especially the ones that might fail. In general, all broken parts could be repaired, nevertheless, it is essential that they can be easily disassembled from each other;
- Color-coded screws and labeled cables inside the device;
- Non-fusion of front glass with the LCD unit;
- Absence of proprietary screws or fasteners;
- Application of zero insertion force (ZIF) connectors for the connection of battery and display with the mainboard; ribbon cables are also a possible alternative;
- Mainboard fixing to the housing via 3 to maximum 7 screws;

The following features have been recognized as inconsistent with design for repair.

Negative features:

- Attachment of numerous subcomponents to a high breakage possibility part – in that case, all of the subcomponents have to be loosened before the removal of the respective part;
- Adhering of housing, battery, mainboard or display;
- Fusing the front glass to the LCD display – in some cases only the front glass is broken, thus its removal from the LCD unit should be easily achieved;
- Adhering the front glass to the panel frame;
- Multi-adhering of components, for instance when the front glass, the backlighting and the digitizing are fused together. Breaking any of these parts will require the replacement of the entire display assembly.

It has been observed that slates greatly differ with regard to design solutions, which in turn have an impact on the complexity of opening, component repair and repair in general. Slates repair can vary from very complex to easy and fast, the judgment depends however solely on single devices.

When information about the slates opening is not being provided, the disassembly would most probably engage a non-damage-free approach. Indeed, the first opening and repair trial of a device just launched on the market would most probably result in its damaging. Thus, knowledge concerning slates opening and repair would be very helpful (e.g. as the repair standard IEEE 1874¹ or oManual²).

The German company active in slates repair has noted that they have been provided by the manufacturer with information on opening and repair. In addition, manufacturers provide the company with special tools (for instance: special side and front opening tools, different press types for the slate assembly and special small size screwdrivers) for the repair purposes.

¹ This Standard defines terminology, data formats and schemas for documents used in describing the repair and assembly of consumer electronics products (source: <http://standards.ieee.org/develop/project/1874.html>)

² oManual is an open XML-based standard for semantic, multimedia-rich procedural manuals (source: <http://www.omanual.org/>)

11 Recycling in practice

The recycling companies visited and interviewed use different pre-treatment approaches - destructive dismantling and shredding technology. The first interviewed recycler (ELPRO, Braunschweig, Germany) follows in general the approach of destructive deep level dismantling where feasible under economic conditions. In the case of the other recyclers (Adamec Recycling GmbH, Fürth, Germany and EGR Elektro-Geräte Recycling, Herten, Germany), after depollution, the end-of-life equipment is being shredded. Information on magnesium recycling has been obtained with the support of Umicore, Belgium.

11.1 Recycling perspective

The interviewed recycling companies noted that currently there are just a few slates being discarded. At the present moment, there are no more than two devices reaching the recycling facility weekly. Thus, the statements on recyclability and disassembly are based on a first judgment of the products. Having said this, the statements made by the recycling companies reflect mainly the considerations respecting future recycling practices. Therefore the conclusions are made on the basis of experience and expert knowledge.

Two priorities from recycling point of view are outlined:

- Worker and facility safety during the processing of the devices;
- Easy and fast opening of the device in order to remove the battery;

With respect to the slates opening, the plastic clips (between 20 and 30) are identified as the most desirable mechanism as they allow fast and easy opening. In general, clips are preferred over screws as they are easier to break and lead to a fast access to the inner components of the slate. For recycling, screws are in general problematic as they slow down the disassembly process. Additionally, they impede the plastics recycling.

Battery removal is from special importance in terms of workers and facility safety. All the interviewed recyclers agreed that they would remove the battery. The time factor is essential for the recyclers, therefore the battery removal should be accomplished easy and fast. It has been mentioned that the slate design should allow the press out of the battery from the device housing.

Completely glued-in battery is not a good solution, as a leverage tool cannot be easily placed under the battery. Nevertheless, if the battery is screwed into a separate frame it could be more easily removed.

The use of reasonable quantity of adhesives for the battery attachment might be preferable over screwed-on battery, under the condition that a spatula can be easily placed under the battery for leverage.

After the battery removal, the recyclers suggested further processing alternatives, differentiating on the facility operating mode as well as under the implication of economic considerations:

- Shredding of the whole device via cross-flow shredder;
- Manual dismantling of the subassemblies, using predominantly screw drivers (battery powered and hydraulic).

In general, plastics are separated according to their color - white (including light grey) and black. White plastics have significantly higher values compared to black plastics. Black plastics contain carbon black which complicates the proper identification and subsequent separation.

The plastics ABS and PMMA are of highest interest due to their significantly higher value. For homogenous ABS and PMMA a price of 800 EUR/t could be achieved, whereas for non-homogenous plastics the price is approximately 20 EUR/t. This significant price difference illustrates the importance of proper identification and separation as well as production of homogenous materials. However, a main drawback for the high value plastics is associated with the often missing or ambiguous information on plastics types contained in the slates.

The content of residues in the plastics may further decrease its value (e.g. metal foils attached to plastics, screws, metal windings and coatings, rubber and adhesive residues as well as colors). Thus, a further shredding process for separation might be incorporated.

Coating and plastics parts attached to bulk plastics parts also reduce the value of the plastics fractions ABS, white mixed plastics and black mixed plastics. Further separation at the plastics recycler is very likely, but not known to the dismantler.

Aluminum housing is of high interest for material recycling and justifies a slightly increased disassembly effort. Magnets (or other metal parts such as copper) attached to the aluminum housing can reduce the recovery value significantly.

The LCD displays might be separated, under the condition that the display can be easily accessed and removed. In general, the front glass would be separated from the LCD unit, if it is not glued to it. However, according to the current practice, they will be processed in the shredder.

At this stage, magnesium parts (from the magnesium frames) are not being separated and collected into individual fraction, but are processed together with the aluminium fraction. As magnesium and aluminium share similar physical properties, it is not easy to separate them mechanically. However, magnesium is an important alloying element for specific aluminium alloys; therefore, its content in the aluminium fraction might not be a problem.

Nevertheless, separation of magnesium parts would be interesting when there are larger flows. Moreover, for high grade magnesium recycling, it is necessary to achieve a fraction as pure as possible.

All PCBs found in slates are considered high-value material (highest PCB grade; including explicitly those from the low-cost slates). In case that the slate is already open, the removal of the PCB would be economically viable. No removal of EMI shields from PCBs is foreseen as the amount of material is not worth the effort. There are basically two processing methods for the PCBs – direct input to a metallurgical processing or the addition of a shredding step prior to the metallurgical processing. Additionally, if PCBs are shredded and potentially undergo further separation of fractions, it might yield a different separation whether EMI shields are clipped-on, screwed or soldered.

Here, it should be mentioned that currently shredding facilities are optimized to process notebooks and computers. However, slates are different from these also in respect to the materials used – the plastic compounds used for slates are much softer, which causes problems during their processing. Additional area of concern poses the front glass (so called gorilla glass). It has been observed that the glass might impede the shredders. In general, modern shredder facilities achieve good separation of the material streams, separating the plastics from the metals. However, the adhesives might cause problems as they could attach to the shredder during their processing.

Flex-foil cables and boards are of high value and will be separated, if easily accessible and removable. Flex-foils are given to the high-value PCB fraction. In case flex-foils are not separated, they will be diluted among other fractions and the valuable materials (i.e. gold) are actually lost. Cables will be cut-off, regardless whether they are fixed with a connector or soldered.

The recyclers mentioned that they have been making proceedings in the disassembly process. Indeed, there have been experimental trials for the disassembly automation of slates. In this case, it is essential to have information about the battery location. However, it is unlikely that slates have identical design, which contributes to the complication of the disassembly automation even more.

According to the recycling companies, information on disassembly process should be provided in advance, ideally as an online data base, including the following aspects:

- A drawing for every slate model, indicating the opening mechanism; in case of clips, this should include information related to the direction the housing should be opened;
- Identification of the content of hazardous substances and their location. Here, the location of the battery and its removal technique is of great importance; the improper battery removal and likely damage are associated with high risk in terms of work as well as facility safety;
- Localization of the printed circuit board;

There have been controversial opinions with respect to the ease of disassembly and recycling of “low-cost devices” compared to high-end products. Some argue that “low-cost” devices feature fewer connections in general and less composite materials; however there was no agreement across the recyclers which device group could be defined as more disassembly friendly. Nevertheless, the share of aluminium and copper in high-end devices is higher, thus of higher interest for the recyclers.

In general, robustness and highly integrated design are in contradiction to a good recyclability and easy dismantling.

12 Summary

Among the 21 DUT analyzed there are **huge differences in terms of complexity**, i.e. in terms of number of process steps required, types of connections used, parts to be removed before access to others is possible. Some devices seem to be over-designed in terms of used screws in particular, but this might be due to some design and robustness considerations which are not obvious at first glance.

12.1 Thermal issues

Thermal issues seem to be not of high relevancy for slates, thus use of certain metal parts and (thermally better conductive) composites does not seem to be justified for thermal reasons. This statement, however, needs further verification (e.g. a detailed analysis of battery ageing due to slightly increased temperatures). **Metal housings are favorable for better thermal management as long as the metal housing does not spread heat from the electronics part over the battery.**

12.2 Design considerations for the first scenario – repair and refurbishment

The objective is to create options for repairmen and refurbishers for the non-destructive and reversible removal and replacement of some potentially replaced components by such activities. Additional interviews with repairmen and refurbishers should be conducted to determine how deeply they would commonly need to disassemble the product. In this report the removal and replacement of the battery, main circuit board and front glass from touch screen displays is addressed to cover the broad range of hypothetical repair and replacement needs. The choice of these target components for repair and replacement is not yet based on any failure statistics. Among these three target assemblies, the mainboard presumably is the one, which rarely needs repair, and accidental damage of the display and front glass might be among the most frequent failures, but this statement is not evidence based.

12.2.1 Opening of the device

The DUTs featured a great variety of designs with respect to the back-cover and housing. The majority was made out of colored plastics. Some DUTs featured rubber coatings. Out of the 21 DUTs a total of six DUTs featured aluminum housing.

We identified three principle opening mechanisms: clips, screws, and adhesives as well as combinations of these. A robust design is important for a long product life. Mobile devices are prone to be dropped or spilt on. Using clips, screws, and adhesives in combination will avoid unintended opening of the device.

In order to open the DUTs without damage in some cases multiple covers needed to be separated such as camera or speaker covers. Not one of the DUTs featured an obvious opening mechanism or supported the opening by providing a groove for allowing easy access for a leverage tool.

With respect to the repair scenario robust clips and screws are feasible design solutions supporting damage-free opening and closing of the slate. The use of adhesive is suboptimal but possible. This will require cleaning and applying new adhesive when closing the device again.

Typically, devices have to be opened either from the back or (few cases) from the front side, removing the display first. In all these cases a repair shop has to work through the whole device before reaching the components placed on the opposite side of the device (display from the backside, usually the battery and/or mainboard from the front side). Two slates feature a design, where the **housing is opened in a way that the frame with the display and the remaining battery-mainboard part are readily separated**, although the opening of these devices is not as straight forward as with several others. Once opened rather easy access to main parts display, battery and mainboard is provided.

For independent repair shops, but partly also for independent recyclers it is of high interest to get hold of **information about the opening mechanism in advance** to save time and more important in case of repair to avoid damage to the surface and parts.

12.2.2 Removal of battery

Despite the specifically designed DUT_21, the disassembly test revealed two basic fastening designs for the battery. The first design option features a battery housing (type of tray) made out of plastics or metal that is attached with an average of four screws to the device. It is unclear why some of the DUTs featured a high number of screws for attaching the battery (e.g. DUT_18 featured 12 screws). With respect to the second design option the battery is directly glued mostly with two strips of adhesives into the device. Both designs are robust and secure the battery in the device.

With respect to the repair scenario both options are feasible although screws have a slight advantage in terms of reversibility and safety. The glued option would most likely require a very delicate approach to lifting the battery. A very interesting solution is DUT_05 that provided a small non-adhesive strip at the end of the adhesive tape that was attached to the backside of the battery. This way **the adhesive tapes could be easily pulled off in order to remove the battery** without requiring further tools, once the battery is accessible.

The glued option will most likely also require a cleaning process.

Beneficial for repair is an **access to the battery without the need to remove the mainboard**, which typically speeds up the process of battery replacement, if deemed necessary.

Batteries with a connector cable to the mainboard are easier to replace than those with soldered wires.

12.2.3 Dismantling of mainboard

With respect to the repair scenario the general utilization of **connectors and screws** are positive design features. The use of connectors allows for a non-destructive separation of the components. **Easy access to connectors** (on the upper side of the boards) **and screws** (not hidden under tapes, access from above) are favorable.

From the detailed disassembly of the mainboard we can draw the conclusion that the large number of connected sub-components (incl. card reader, cameras, antennas, speakers) requires a considerable amount of time and delicate handling in the disassembly process, if non-destructive removal of the board is intended. The use of screws for securing the mainboard is a typical design. What was surprising was the sometimes large number of screws (DUT_05 with 7 screws) with which the mainboard was attached.

12.2.4 Dismantling of display unit

The dismantling of the display unit is a particularly relevant for the repair scenario although the separation of the glass and recovery of specific materials (e.g. rare earth metals from the LEDs or indium from the display) might be of interest for recyclers in the long-term future.

With respect to the repair scenario the front opening and simple connecting approach of DUT_07 and DUT_12 with only 4 screws and two connectors appears very practical. The procedure is still sophisticated and should not be

done by a lay person. The exchange of front glass touch panel or the display unit requires professional substitution of the glued parts.

In some slates the **front glass can be quite easily lifted off the LCD panel**, which is a good option, if only the front glass is broken and needs replacement.

In the case of the other products, the non-destructive removal of the display was mainly complicated by the considerable amount of steps that are necessary to gain access. These multiple steps increase the danger of damaging other subassemblies or parts of the product. They are also very time-consuming. Due to the fact that most parts are fastened with connectors and screws, reversibility of the process is possible.

12.3 Design considerations for the second scenario – commercial recycling for optimal material recovery

The objective is to create options for recycling facilities to conduct the following: depollution of the product by removal of battery and other required components, and removal of components that contain the highest resource and/or financial value if recycled in a clean stream separate from other materials. It is assumed that following removal of these components, the product will be shredded for material recycling. Interviews with additional recyclers should be conducted to determine how deeply they would commonly choose to manually disassemble before shredding. In this report the removal of the battery, main circuit board, and aluminum or magnesium housing and frames is addressed. Dismantling the display unit for separate recycling is not indicated at this time.

12.3.1 Opening of the device

With respect to the recycling scenario other design requirements apply. Time efficient opening and dismantling of the main subassemblies is the main interest of the recycler. The separation of individual material fractions must be achieved within a few seconds and under a minute in order to be cost efficient. The opening must be possible with rough tools (not small screw drivers and pliers) allowing instant access and leverage. The destructive approach of the recycler has one limitation: the safe removal of the battery.

Notches for easier opening of the housing have been mentioned also by the recycler as a potentially useful design feature.

Mono-material plastic housing parts without coatings, inserted metal windings, metal shields attached are better to recycle than composite materials.

White plastic parts have a higher recycling value than colored or black plastics parts.

12.3.2 Dismantling of housing or frame

Aluminum housing parts are of interest for a recycler and even justify an increased dismantling effort, if no problematic composite materials remain as residues on the metal parts. An **inner magnesium frame** similarly is of interest for metal recycling, but as currently only minor amounts of magnesium are contained in typical WEEE and much higher aluminum amounts, only for the latter recycling logistics are established at large, and magnesium might not be separated.

12.3.3 Removal of battery

The removal of the battery is required in the European Union through the WEEE directive. Slate DUT_21 features **readily replaceable batteries**, so exchange and separation at end of life is no issue at all (as long as the device is handed over to the recycler with the battery still attached).

With respect to the second scenario (recycling) the safe removal of the battery has the highest priority for the recycler. The recycler should have knowledge about the position of the battery in order to avoid damage and the danger of an explosion, fire and exposure of chemicals. Damage to other parts of the product or connectors is not a factor for recyclers. A low number of screws (about 4) as well as a moderate utilization of adhesives (1 or 2 strips) will improve the time efficiency.

The specific design of DUT_21 has considerable advantages and supports both scenarios in the best possible way.

12.3.4 Dismantling of mainboard

The dismantling of the mainboard is a relevant scenario due to the component and material value.

A direct access to the mainboard is of greatest value. The use of screws is less problematic if the number of screws is kept low or if the screws can be broken out. The use of connectors would probably also not interfere with a recycling scenario because they are easily ripped apart. Also, a glued option is feasible as long as a leverage tool can be easily slipped underneath the main board.

12.3.5 Dismantling of display unit

LCD displays contain rare earth elements in minute quantities in the LED backlights, and recycling systems are not in place to recover them efficiently. In the future it may be indicated that such materials be recovered and recycling capabilities may be developed. At that time dismantling of the display unit and particularly of LED backlights may be indicated for recycling. Furthermore, minor amounts of gold are typically used for interconnects and connectors of LEDs, and line and row controlling ICs. If these can be ripped apart (flex boards), they can be processed with high value printed circuit board fractions for precious metal recovery. Design features in this respect have not been analysed in detail as it is not known, that such minor assemblies are separated by any LCD processing facility.

With respect to the recycling scenario the time needed to separate the display unit from the rest of the device is critical. As slate displays do not contain mercury containing backlights, separation of the display is of lower priority than for e.g. older laptops, monitors and TV sets. The front approach again seems to have advantages in that respect.

12.4 Repair perspective

The complexity of disassembly and repair is considerably affected by the large variety within the designs of slates.

Information on internal design, opening and repair is recognized as having high importance for the repair company. It should be available in form of central information system that provides information on repair for all devices available on the market.

With regard to the opening, screws have been identified as the most favorable closing mechanism in terms of damage-free opening and reversibility.

Adhesives should not be used as they require the use of heating tools, which may cause damage to the battery or other sensitive components.

The display and the battery have been recognized as the components that are most prone to damage. Therefore, in the slate design the easy and damage-free access to these parts should be considered as well as their easy replacement. Having said this, the fusion of the front glass with the LCD unit and the front frame in addition to the over-gluing of the battery to the housing are regarded as especially negative design solutions.

12.5 Recycling perspective

The recyclers were able to make only assumptions with respect to recycling practices due to the current low discard rate of slates.

The interviewed recycling companies follow two different pre-treatment approaches. The first one focuses on more deep level dismantling whereas the other two recyclers have been associated with the implementation of rather shredder technologies.

Nevertheless, the battery has been recognized by all of the recyclers as having the highest removal priority. Across the battery attachment solutions, the use of screws is rather undesired. Here, the glued-in battery might be preferred, but only under the premise that a leverage tool can be placed beneath. However, it has been noted, that it should be possible to press the battery out of the slates housing.

All recyclers agreed on the importance of the information related to opening and disassembly. It would be helpful to have knowledge about the localization of hazardous substances, in particular battery positioning as well as localization of the mainboard. The information is in particular important with regard to future automation of the disassembly process, especially when the amount of discarded devices increases significantly.

Concerning the opening, clips are preferred over screws. The application of adhesives is not welcome at all. In general, the use of many screws is problematic as they increase the disassembly time. In such case, the recyclers would proceed to a cruder processing.

Mainboards would be separated only in case the device has been already opened. EMI shields are not going to be separated. Most probably, the mainboards will be shredded with the rest of the device.

Magnesium frames would not be collected as a separate fraction as there is no interest for it at the present moment. They would be processed together with the aluminium fraction. Individual magnesium collection would be meaningful for consideration only when the quantities of discarded slates rise significantly.

The plastics are in general of interest for the recycler. The homogenous plastics have substantially higher values compared to mixed materials. Metal and adhesive residues could further decrease the value of plastics.

12.6 Additional Observations and Outlook

In general there is no optimal design, which is the best option under all scenarios: **Those devices, which feature better access to battery and mainboard for replacement and repair typically do not allow easy access to the display unit and vice versa.** Also the question whether screws or glues and adhesives are preferable cannot be answered unambiguously: For repair screws are the better option, but for material separation glue seems to be favorable over a multitude of screws. **Products, which seem to be more robust** (but be aware that robustness as such was not analyzed in this study) **are less disassembly-friendly.** We strongly recommend clarifying and discussing realistic scenarios first, before taking our analysis as a basis to define EPEAT criteria:

Which components actually might need repair or replacement?

Who is supposed to do repair typically (OEM service contractors, independent professionals, or experienced lay persons)?

Who is in charge of recycling (take back of large numbers of units with same design or general WEEE recyclers with a broad and varying material input flow, deep level dismantling or shredding)?

A repair scenario makes no sense, if spare parts are not available. If these scenarios are not evaluated properly in advance, criteria might reflect scenarios, which are not relevant in practice.

In the development of eco-design criteria there are several general observations that must be considered, and that would apply to all or most end-of-life scenarios.

We observed huge differences in terms of product design and complexity, causing the methods of product disassembly to vary greatly. If the individual handling the product does not have access to specific design information, there can be unfortunate outcomes, such as:

- A repairer or refurbisher could cause unnecessary damage, possibly degrading the product's value.
- Efforts at depollution could be ineffective.

- A recycler could spend unnecessary time accessing critical components, increasing cost and possibly even making their recovery cost prohibitive.

Only in exceptional cases such information is available, e.g. as a comprehensive service manual. For these products in particular, a source of disassembly information could be made available to repairers, refurbishers and recyclers to enhance their processes.

Removal of the housing to open the device is essential for all handlers, but it is often not at all apparent how this can be done, nor was their much evidence that ease of access was taken into consideration in product design, except for a few products.

There is little evidence in most product designs that the needs of the end-of-life actors have been taken into consideration. However, there is great variability, and there are notable exceptions, which demonstrate the viability of opportunities to do so.

In the report we use several terms such as “easy”, “bad access”, “suboptimal”, “simplicity”, etc. These concepts may be apparent in application, but are problematic when defining eco-design requirements. We also note that “to quantify process times for recycling or repair...no metrics can address properly the design specifics of slates...” Thus we focus on “design facts and differences”. Likely eco-design guidelines will also need to take this approach.

We also note that the availability of spare parts is essential for any repair or refurbishment activity. This was not investigated.

Finally, it has to be stressed again, that in the course of developing EPEAT criteria it is required to discuss thoroughly, **whether any of the D4R design measures has an adverse effect on other life cycle aspects** (e.g. reducing the number of screws on the mainboard might mean less robustness for connectors; more clips on the cover mean better robustness and one breaking clip of many might be tolerated, but disassembly times will increase with the number of clips; avoiding composite material might require a larger form factor and higher overall resource consumption) **or on device performance** (e.g. less integrated design might need a change to a battery with less capacity, thus potentially a shorter overall product lifetime).