

# Reliability of Power Converters in Wind Turbines: Exploratory Analysis of Failure and Operating Data from a Worldwide Turbine Fleet

Katharina Fischer, Karoline Pelka, Arne Bartschat, Bernd Tegtmeier, Diego Coronado, Christian Broer, and Jan Wenske

**Abstract**— In view of the frequent and costly failures of power converters in wind turbines, a large consortium of research institutes and companies has joined forces to investigate the underlying causes and key driving factors of the failures. This paper presents an exploratory statistical analysis of the comprehensive field data provided by the project partners. The evaluated dataset covers converter failures recorded from 2003-2017 during almost 7400 operating years of variable-speed wind turbines of different manufacturers and types, operating at onshore and offshore sites in 23 countries. The results include the distribution of failures within the converter system and the comparison of converter failure rates among turbines with different generator-converter concepts, from different manufacturers as well as from different turbine generations. By means of combined analyses of converter-failure data with operating and climate data, conditions promoting failure are identified. In line with the results of a previous, much smaller study of the authors, the present analysis provides further indications against the wide-spread assumption that thermal-cycling induced fatigue is the lifetime-limiting mechanism in the power converters of wind turbines. Instead, the results suggest that humidity and condensation play an important role in the emergence of converter failures in this application.

**Index Terms**— Converters, power electronics, failure analysis, reliability, wind turbine.

## I. INTRODUCTION

THE main power-converter system in wind turbines (WT) is a frequent source of failure and, as such, a driver of repair cost and downtime. The problem of high converter failure rates is limited neither to single manufacturers nor to specific sites. It is rather observed worldwide and in a multitude of different WT types, as proven by numerous studies and widely confirmed by the experience of WT

This work was supported by the Federal State of Lower Saxony with funds from “Niedersächsisches Vorab” and by Fraunhofer-Gesellschaft.

K. Fischer, K. Pelka, A. Bartschat, B. Tegtmeier and C. Broer are with Fraunhofer IWES, Fraunhofer Institute for Wind Energy Systems, D-30167 Hannover, Germany (e-mail: [katharina.fischer@iwes.fraunhofer.de](mailto:katharina.fischer@iwes.fraunhofer.de), [karoline.pelka@iwes.fraunhofer.de](mailto:karoline.pelka@iwes.fraunhofer.de), [arne.bartschat@iwes.fraunhofer.de](mailto:arne.bartschat@iwes.fraunhofer.de), [bernd.tegtmeier@iwes.fraunhofer.de](mailto:bernd.tegtmeier@iwes.fraunhofer.de), [christian.broer@iwes.fraunhofer.de](mailto:christian.broer@iwes.fraunhofer.de)).

D. Coronado was with Fraunhofer IWES and is now with CGN Europe Energy, 11 Cours Valmy, F-92977 Paris, France (e-mail: [diego.coronado@cgnpc.com.cn](mailto:diego.coronado@cgnpc.com.cn)).

J. Wenske is with the Fraunhofer IWES, D-27572 Bremerhaven, Germany (e-mail: [jan.wenske@iwes.fraunhofer.de](mailto:jan.wenske@iwes.fraunhofer.de)).

operators. As a basis for the development of effective countermeasures, it is crucial to understand the prevailing mechanisms and causes of converter failure in wind turbines. This has been the main subject of a research cluster formed by a consortium of 16 companies including wind-turbine and component manufacturers, operators and maintenance-service providers, as well as Fraunhofer institutes and academia [1, 2]. Using a field-experience based approach, the research work within this cluster builds on a systematic analysis of comprehensive failure and operating data provided by the project partners, on field measurement campaigns and on post-mortem analysis of converter hardware to identify the main root causes of failure.

### A. Power converters in wind turbines

Power converters are key components of almost all modern wind turbines. Located between the generator and the WT transformer, they enable variable-speed operation and ensure grid-code compliant behavior of the turbine. The generator-converter topologies commonly used in WT are:

- doubly-fed induction generators (DFIG) with partially rated converters,
- squirrel-cage induction generators with full-scale converters (IG+FPC), and
- permanent-magnet or electrically excited synchronous generators (PMSG, EESG) with fully rated converters.

The converter technology prevailing in the wind application consists of low-voltage 2-level IGBT-based voltage source converters in back-to-back configuration. Figure 1 shows such a converter in its simplest form.

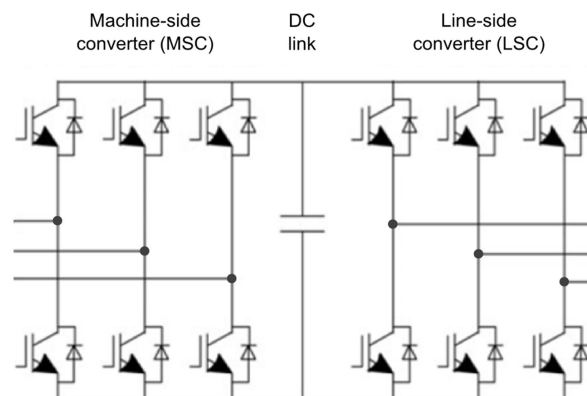

Fig. 1. Voltage-source converter topology prevailing in wind turbines

Due to the limited current-carrying capacity of a single power semiconductor, each device in Fig. 1 represents a larger number of paralleled IGBTs or diodes, respectively. If necessary, several of the units shown in this figure are again connected in parallel in a WT, typically with a joint DC link.

3-level and modular multilevel converters for the wind application are commercially available, but have not achieved a broad distribution in the field yet. Generally speaking, the widely expected shift towards the use of medium-voltage (MV) converters in WT with more than 3-5 MW is not observed so far. As first examples, the turbine types Areva M5000/Adwen AD5, Mervento 3.6, XEMC XD115 and Adwen AD8 can be named, all of which are equipped with MV-PMSG and fully rated converters. Depending on the manufacturer, either IGBTs (e.g. ABB) or MV-IGBTs (e.g. Converteam, Ingeteam) are applied in the MV converters [3]. However, the majority of new turbine types, such as Siemens Gamesa SWT-7.0/SG-8.0, Enercon E126-7.58 and MHI Vestas V164-8.0, continues to use low-voltage IGBT converters. For a comprehensive overview of the different power-electronic converters applied in or suitable for WT, including low-voltage and medium-voltage topologies, please refer to [4].

#### B. Research on power converter reliability in wind turbines

The publicly available scientific literature covering the reliability of the (main) converters in WT can be mainly assigned to two categories:

- (a) field-data based failure statistics or reliability studies, respectively, typically with a system-level focus, and
- (b) theoretical lifetime calculation based on mission profiles and existing lifetime models, however, without consideration of the failure modes occurring in the field.

Major contributions in the category (a) include the reliability study based on 373 variable-speed WT with rated capacities  $\geq 850$  kW carried out within the RELIAWIND project, using data from 2004-2010 covering in total 1115 WT operating years [5, 6]. In addition, the comprehensive work at the University of Durham (e.g. [7, 8]) on the basis of field data from 1993-2004, as well as that of ISET / Fraunhofer IWES based on data from the WMEP program from 1989-2006 (e.g. [9, 10]) fall into this first category. Their relevance for today's wind turbine technology is, however, limited by the old and technologically in many cases outdated WT fleets underlying these studies. More recent reliability studies on WT have been published by the University of Strathclyde (cf. [11, 12, 13]). These are based on comprehensive field data from WT of one of the leading manufacturers. However, as the main purpose of that work is operations and maintenance (O&M) modelling, it provides little information that could support an identification of the causes of power-converter failure. Another relatively recent system-level reliability study based on >5800 failures reported during 2010-2012 in a fleet of Chinese wind turbines is published in [14]. In line with the results of European studies, the largest portion of failures is allotted to the power converter also in the Chinese fleet.

The wind-power specific scientific literature dealing with lifetime estimations of power converters that falls into the abovenamed category (b) has been strongly focused on the failure mechanisms of power electronics in other areas of

application so far: the gradual degradation of die-attach solder as well as the lift-off or damage of bond wires (see e.g. [15, 16, 17, 18, 19, 20]). Both failure modes result from fatigue caused by the long-term impact of thermal cycling of material combinations with different thermal expansion behavior. For these 'classical' failure modes of power electronics, lifetime models are available (e.g. [21, 22, 23]), which might explain the attractiveness of assuming their dominance for theoretical lifetime calculations. Furthermore, also the design and accelerated life testing of today's power modules are primarily focused on these fatigue-based failure mechanisms. One of the consequences of this strong focus on bond-wire and solder fatigue is that the wind-power specific literature has concentrated mainly on the machine-side converter in WT with DFIG (see e.g. [24, 25, 26, 27, 28]) as well as in WT with low-speed PMSG (e.g. [29, 30, 31, 32]). Because these converters are subject to high currents at low frequencies and therefore to particularly severe thermal cycling [33], they have been considered to have a particularly high risk of failure.

Within the project CONFAL [34, 35], converter failure in WT was systematically investigated for the first time by means of a field-data and field-experience based approach, with the objective to shed light on the causes of failure. Subject of the investigation were two WT types of similar rated capacity, but from different manufacturers, one of them with DFIG, the other of IG+FPC-type. In CONFAL, field data from approx. 370 operating years was evaluated. The analysis of this data as well as of several defect power modules from the field provided indications of insufficient protection of the converters against the environment (salt, insects, humidity and condensation) as well as, in case of one wind park, some temporal coincidence of thunderstorms and converter failures. A particularly interesting result was that the post-mortem-analyzed power modules lacked any signs of fatigue damage – an observation that has raised the question if thermal-cycling induced fatigue damage plays in fact a relevant role in the emergence of the converter failures in WT. To answer this question based on a much more comprehensive and varied WT fleet and to identify the (possibly different) key drivers of converter failure in the field is among the main objectives of the initially introduced research cluster and the work presented in the following.

A previous paper of the authors, [36], presented first results of statistical analyses carried out within this research cluster. It used a data subset covering 1269 wind-turbine operating years to identify the most frequently failing components and the main repair-cost drivers within the power-converter system.

This paper presents converter-specific failure statistics based on a substantially extended field-data basis provided by the partners of the research cluster, which now includes almost 7400 years of wind-turbine operation. The work is novel and unique due to

- (i) the comprehensiveness, depth and timeliness of the data basis,
- (ii) the focus on statistical analysis for the purpose of failure root-cause identification,
- (iii) the combined evaluation of failure and operating data, which allows to identify operating conditions promoting converter failure.

### C. Paper outline

The subsequent parts of the paper are structured as follows: Section II describes the data basis underlying the subsequent analysis and introduces the processing and evaluation methods. Section III presents and discusses the results of the different data analyses. Section IV summarizes the main conclusions and provides an outlook to further work.

## II. DATA BASIS AND METHODS OF ANALYSIS

### A. Data underlying the analysis

The failure data covers in total 2734 wind turbines with a main converter, which are operating in 23 different countries spread over four different continents (see Fig. 2).

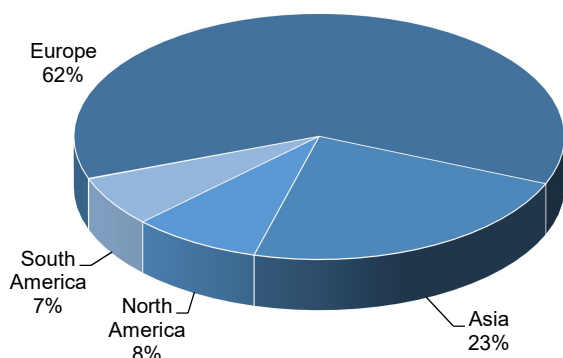

Fig. 2. Distribution of the evaluated diverse wind-turbine fleet over continents (portions based on the number of turbines)

The turbines are equipped with DFIG, EESG or IG+FPC. In addition, there are single turbines with PMSG. The dataset covers turbines by eleven different manufacturers, namely DeWind, Enercon, Fuhrländer, Gamesa, General Electric, Kenersys, Nordex, Senvion, Suzlon, Siemens, and Vestas. The nominal power of the turbines ranges from 500 to 3600 kW. Their commissioning dates spread over the years 1997-2015.

All power converters in the investigated turbines are low-voltage 2-level IGBT-based voltage source converters, i.e. of the prevailing technology in wind turbines (cf. Section I.A). In the EESG-based WT, the AC-DC conversion on the generator side is implemented by means of diode- or thyristor-based rectifier. In addition, these turbines contain a unit for the electrical excitation of the generator and, depending on the WT type, a step-up unit in the DC link. In the present paper, these components are considered as parts of the power-converter system.

Inside the turbines, the power converters are located inside the nacelle or in the tower base. Alternatively, in some WT types, the machine-side converter is placed in the nacelle and the grid-side converter in the tower base. In single cases of WT built on lattice towers, the converters are located in a station next to the tower base. The converters are either air-cooled or liquid-cooled.

The data includes converter failure events from 2003 to 2017. The length of the periods, from which failure data has been evaluated, ranges from several months to 12 years per turbine. Figure 3 illustrates the total number of operating years covered by the dataset from turbines of different ages. Note

that this includes both turbines with and without converter failures. With a total number of more than 1500 turbine operating years, most data is available from turbines in their first year of operation. The dataset includes similar amounts of data from turbine ages of 3 to 13 years and – to a minor extent – from older turbines with an age of up to 19 years. In total, the evaluated failure data covers almost 7400 WT operating years, with a portion of approx. 10% from offshore wind parks. For a small portion of the evaluated fleet, the turbine age is unknown. The pie chart included in Fig. 3 shows the data portions corresponding to the each of the eleven WT manufacturers (OEM). In addition to the failure data, the data basis comprises operating histories in the form of 10min-averaged signals from the Supervisory Control And Data Acquisition (SCADA) system as well as SCADA status-logs from more than half of the turbines.

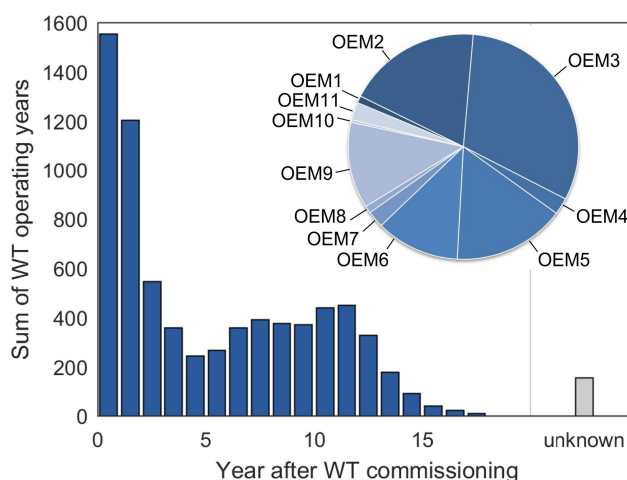

Fig. 3. Amount of evaluated data from wind turbines of different ages (bar chart) and portions of turbines by different manufacturers (pie chart, based on evaluated number of WT operating years)

The converter-specific failure data has been derived from maintenance reports including information on used spare parts or from turbine logbooks. Only faults requiring on-site repair and the consumption of material or spare parts are counted as failure events. Faults remedied by measures such as a remote reset, cleaning or retightening of components are therefore not included.

Based on the above information, failures are classified using the following converter-component categories: phase module (including IGBT modules and corresponding driver boards, DC-link capacitors, busbars; in EESG-based WT also the corresponding components in the excitation unit), converter control board, cooling system, main circuit breaker, grid-coupling contactor, other converter failures. Note that a failure event can cover several of these categories in case components of more than one category were replaced in order to restore the functionality of the converter.

### B. Calculation of failure rates and their confidence intervals

The present analysis is based on average failure rates, which is a common measure for assessing the reliability of a component, not at least due to its suitability for cases with lacking information about the component age. The average

failure rate of a component is defined as

$$f = \frac{\sum_{i=1}^I N_i}{\sum_{i=1}^I X_i \cdot T_i} = \frac{N}{T} \quad (1)$$

with  $N_i$  denoting the number of failure events of this component in the time interval  $i$ ,  $X_i$  describing the total number of turbines evaluated in this time interval, and  $T_i$  being the duration of the time interval. The overall number of observed failure events of the component of interest will be denoted  $N$  and the total number of evaluated wind-turbine operating years  $T$ , including both failed and non-failed turbines. All failure rates are given in failures per wind turbine and year ( $1 \text{ a}^{-1} \approx 1.14 \cdot 10^5 \text{ FIT}$ ).

Although average failure rates are widely used in wind-turbine failure statistics, the conclusiveness of the sole failure rates is limited by the fact that they do not provide information about the uncertainty their value is afflicted with. E.g. the occurrence of 10 failures during 50 WT operating years results in the same failure rate of  $0.2 \text{ a}^{-1}$  per turbine as 100 failures observed in a total of 500 operating years, while the uncertainty of the failure-rate value is much higher in the first case. As the present paper will compare the failure rates of different groups of turbines, with large differences in the covered amount of turbine operating years between the groups, it takes a step beyond previous failure-rate analyses by quantifying the uncertainty of the provided failure rates by means of confidence intervals.

Instead of a single value, a confidence interval provides a range for a parameter of a population's probability distribution. Its lower and upper limit are constructed to meet a level of confidence  $(1-\alpha)$ , with  $0 < \alpha < 1$ . A two-sided confidence interval for the parameter  $\theta$  with confidence level  $(1-\alpha)$  is an interval with the boundaries  $[\theta_l, \theta_u]$  that has the property  $P(\theta_l \leq \theta \leq \theta_u) = 1-\alpha$ . When confidence intervals are estimated based on sample data, the confidence level is to be interpreted in terms of frequency: If a large number of samples (i.e. failure datasets from a given population of wind turbines) was evaluated, the confidence level would be equal to the proportion of the samples whose confidence limits contain the true parameter.

The time periods  $T_i$  in the dataset evaluated for the present paper are time-censored, i.e. they are not terminated with component failure. As described in [37], the confidence interval for the average failure rate incorporating time-censoring is estimated according to

$$\left[ \frac{\chi^2\left(\frac{\alpha}{2}, 2N\right)}{2T}, \frac{\chi^2\left(1-\frac{\alpha}{2}, 2N+2\right)}{2T} \right], \quad (2)$$

where  $\chi^2(\alpha/2, 2N)$  is the  $(\alpha/2)$ -quantile of the chi-square distribution with  $2N$  degrees of freedom. In the present paper, the average failure rates are presented with the 90% confidence intervals, corresponding to  $\alpha=0.1$ .

For the abovementioned example, this results in a confidence interval of  $[0.1085 \text{ a}^{-1}, 0.3392 \text{ a}^{-1}]$  for the case of

10 failures observed in 50 WT operating years. In contrast with  $[0.1683 \text{ a}^{-1}, 0.2362 \text{ a}^{-1}]$ , it is more narrow in case of 100 failures during 500 WT operating years, indicating a higher certainty of the calculated average failure rate in the second case.

### C. Combined evaluation of failure and operating data

For the failure events of selected converter-component categories, the date and time of failure as well as the operating conditions in the 10min-interval preceding the failures are identified from the turbines' SCADA 10min-data and/or status-logs. Figure 4 illustrates this procedure. It shows a 3-day excerpt of the 10min-averaged signals wind speed, active power and generator speed, with a low-wind period on the first day and part-load operation ended by a failure event on the second day. The information that the failure concerns a component of the power-converter system is obtained from the maintenance records and the status-logs.

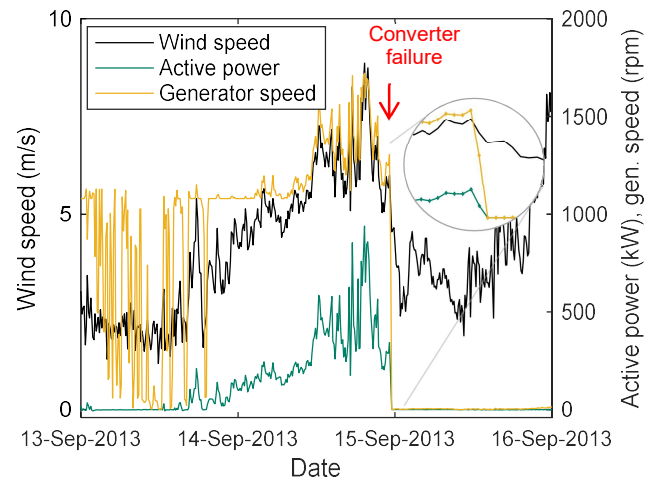

Fig. 4. Identification of operating conditions preceding converter failure from the operating history (SCADA 10min data) of a 1.5 MW wind turbine

A magnified view of the signals around the time of failure in Fig. 4 shows the sudden drop of the generator speed and the active power while the wind speed is still well above the turbine's cut-in wind speed. It is important to note that the last 10min-averaged value above zero before the downtime is typically no suitable characterization of the turbine operating condition in the moment of failure, because it is the result of an averaging over a 10min-interval that covers both operation and downtime. To identify the approximate load range in which the converter failure occurred, it is therefore necessary to evaluate the preceding time-step. In the case shown in Fig. 4, this corresponds to the local maximum of the generator speed and the active power of 342 kW. As the turbine has a rated power of 1500 kW, this failure event is assigned to a load range of 20-30% of the rated power.

## III. RESULTS AND DISCUSSION

Based on the field data described in the previous section, a variety of different analyses have been carried out. Their results are presented and discussed in the following.

### A. Distribution of failures over converter components

In order to identify the predominantly failing components in the converters of WT, all turbines for which failure data from the complete converter system is available have been evaluated with respect to the distribution of the affected converter components. Figure 5 shows the distribution of failed components over the converter-component categories defined in Section II.A.

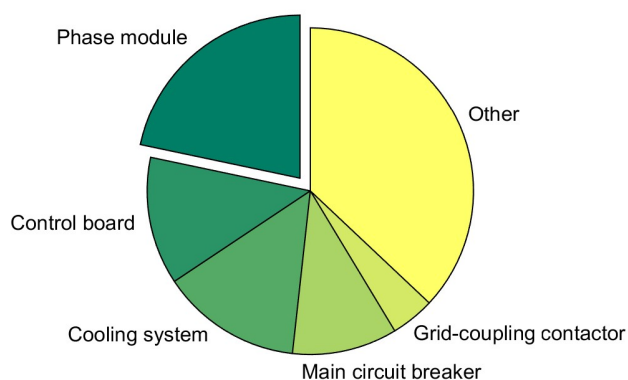

Fig. 5. Distribution of failed converter components over categories, based on 3829 operating years of wind turbines of different generator-converter concepts and types

Taking into account that the category “Other” covers a large number of different – mostly minor – items, it reveals that with 22% the phase-module category makes up the largest portion of failed converter components. In 26% of all converter-failure events, the phase-module category was affected. (Note that the discrepancy between 22% and 26% is caused by the fact that in a part of the failure events components from more than one category were found to be defect, so that the overall number of failed components is larger than the number of failure events.) Besides the phase module, the cooling system (mainly with fan and pump failure as well as coolant leakage) and the control board of the converter are frequently failure-affected components. As the phase-module category stands out not only with respect to the portion of failures, but also with a high repair cost among the converter components, as a previous study of the authors [36] showed, a particular focus will be set on the analysis of phase-module failures in the following parts of this paper. In the majority of the WT investigated, the phase modules are replaced as a unit after a failure and information about the location of the defect within the phase module is not available. Solely in the group of turbines with EESG and full power converters, a further distinction of failed components within the phase-module category has been possible. In these turbines, power-module and driver-board failures occurred at similar frequencies and prevailed clearly over failures of DC link capacitors or busbars.

### B. Converter failure rates of wind turbines with different generator-converter concepts

Different generator types involve distinctive operating conditions and loads for the converter. In search of factors

benefitting or counteracting converter reliability, it is therefore a reasonable step to compare the converter failure rates of WT with different generator-converter concepts.

Figure 6 shows the average converter failure rates of turbines with DFIG, EESG and IG+FPC as well as of the evaluated turbine fleet in total. In addition to the bars indicating the average failure rates, the diagram includes the confidence intervals calculated according to Equation (2) in Section II.B. Note that the amount of available data, characterized by the sum of evaluated WT operating years, varies considerably between the groups of turbines, but also within the groups of turbines. The former results from the composition of the turbine fleet covered by the data (see Section II.A), which is strongly dominated by DFIG turbines. The latter is a consequence of the fact that only phase-module failures were reported from a portion of the turbines. In case of the turbine group ‘IG+FPC’, data covering the complete converter system was considered too limited to allow conclusive results and was therefore excluded from the analysis.

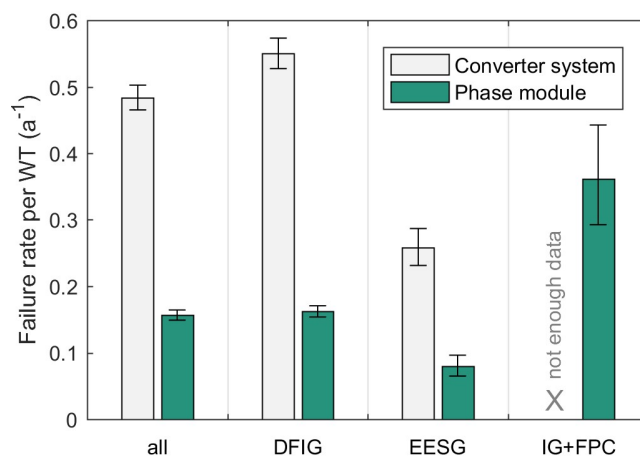

Fig. 6. Comparison of average failure rates of the overall converter system (left bar) and the phase-module components (right bar) as the core of the converter among wind-turbine groups with different generator-converter concepts

On average, 0.48 power-converter failures per wind turbine and year occurred in the fleet. Among these are 0.16 a<sup>-1</sup> phase-module failures per WT. As indicated by Fig. 6, the failure rates obtained for the fleets with DFIG, EESG and IG+FPC differ strongly: The EESG fleet shows a significantly lower failure rate than the DFIG fleet, both regarding the phase-module category and regarding the complete converter system. The turbines with IG+FPC have the highest phase-module failure rate.

The widths of the failure-rate confidence intervals in Fig. 6 depend on both the number of failures and the amount of evaluated operating years, cf. Equation (2). This is clearly reflected in Fig. 6, where the failure rates calculated from a large data basis such as in case of the DFIG turbines have a narrow confidence interval (e.g. [0.149 a<sup>-1</sup>, 0.164 a<sup>-1</sup>] for the phase-module failures) while the uncertainty is much higher in case of the relatively small fleet of turbines with IG+FPC (with a broad confidence interval of [0.293 a<sup>-1</sup>, 0.443 a<sup>-1</sup>]).

### C. Converter failure rates of DFIG-based wind turbines of different manufacturers

Turbines with DFIG constitute the largest portion in the data basis assembled for the present work. This allows splitting the DFIG-based fleet into sub-groups of WT in order to compare the converter reliability in DFIG turbines of different manufacturers. Figure 7 shows the resulting diagram. The names of the WT manufacturers are anonymized for the sake of confidentiality. The evaluation is based on failure data from 75 to 2316 WT operating years per OEM (cf. Fig. 3). Besides the WT by manufacturer OEM6, for which only phase-module failure data has been available, the diagram shows the failure rates of all converter-component categories. Note that the failure rates of the different component categories do not sum up to the converter-system failure rate, but that their sum is usually higher than the overall failure rate. This results from the fact that a part of the failures has affected more than one component category. Such cases are included in the failure rate of each affected category, but considered only a single failure event in the calculation of the converter-system failure rate.

Figure 7 reveals that there are large differences in the failure behavior of the turbines of different manufacturers, both with respect to the reliability level and the distribution of failures within the converter system. The average failure rate of the overall converter system ranges from  $0.235 \text{ a}^{-1}$  per turbine (OEM5) to a value as high as  $1.539 \text{ a}^{-1}$  (OEM1). On a similar note, the phase-module failure rates vary from  $0.034 \text{ a}^{-1}$  per WT (OEM7) to  $0.266 \text{ a}^{-1}$  (OEM4) among the fleets from different manufacturers, i.e. by a factor of almost eight. The results make clear that, in spite of the widespread occurrence of high converter failure rates in wind turbines, low converter reliability is not inherent to the wind application; the fact that the converters and in particular the phase modules in WT of certain manufacturers achieve such low failure-rate levels proves that a relatively high reliability can be realized already with existing converter technology, which is an important finding.

In addition to the different reliability levels, Fig. 7 shows that the converter systems used by the WT manufacturers OEM1...OEM8 have different weak points: In most of the

cases, the phase-module category has the highest failure rate (apart from the cumulative category "Other"). In the case of single manufacturers, however, the failure rates of the converter cooling system (OEM1 and 7) or of the main circuit breaker and the converter control-board (OEM1) exceed those of the phase-module category considerably.

### D. Generator-side vs. grid-side converter failures in DFIG turbines

In addition to the failure rates of the different converter components presented in the previous sections, also the distribution of failures over the machine-side and the line-side converter can reveal relevant insights. This applies in particular for turbines with DFIG: If the lifetime of converters in WT was indeed predominantly determined by thermal cycles and the resulting fatigue of bond-wire connections and die-attach solder on the chip level, as it is widely postulated in the scientific literature, failures should be observed mainly in the machine-side converter in DFIG turbines, which is subject to particularly severe thermal cycling due to the low current frequencies.

This is investigated on the basis of the field data described above. The analysis can be carried out for DFIG turbines of three different manufacturers, namely OEM3, 5 and 6 introduced in Section C, with in total 660 failure events of IGBT modules (incl. the driver board). In case of OEM3 and OEM6, the evaluated failure data originate from the first five years after commissioning, while in case of OEM5 the analysis includes data from WT with operating ages up to 13 years.

Figure 8 shows the distribution of IGBT-module failures over the machine-side converter (MSC), the line-side converter (LSC) as well as the chopper module used for voltage limitation in the DC link. In case of OEM3, MSC and LSC failures are found in approximately equal portions, while LSC clearly outnumber MSC failures in the WT of manufacturer OEM6. This is a strong indication against the assumption that thermal-cycling induced fatigue is a relevant cause of the observed converter failures. Solely in case of OEM5, the largest portion of failures is found in the MSC. The fact that, in contrast to the other two cases, also older WT of operating ages up to 13 years are included raises the

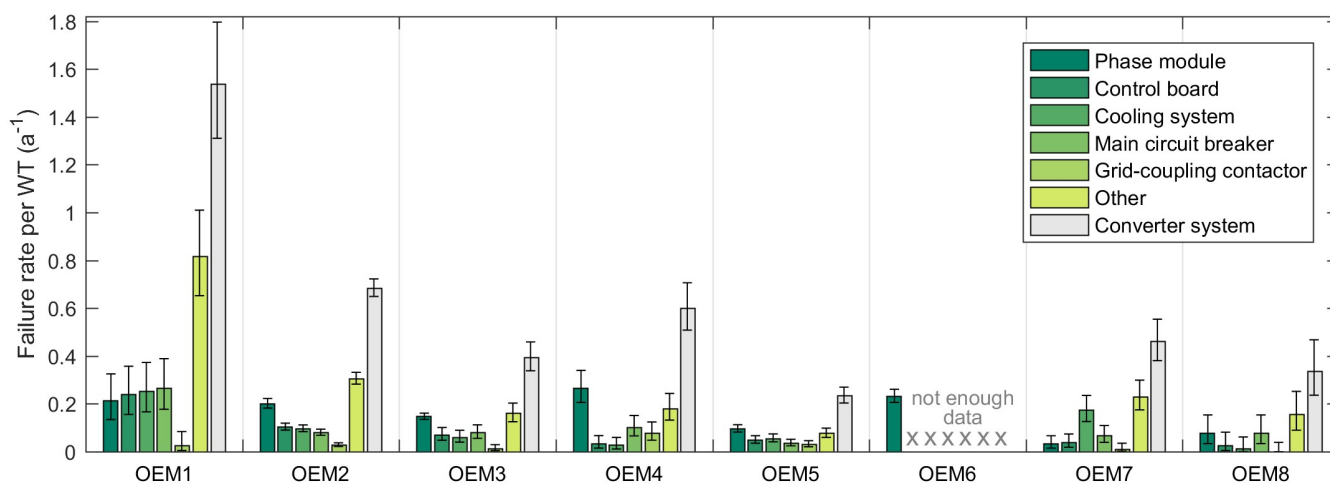

Fig. 7. Average failure rates of the overall converter system and its components in groups of DFIG-based wind turbines of manufacturers OEM1...OEM8

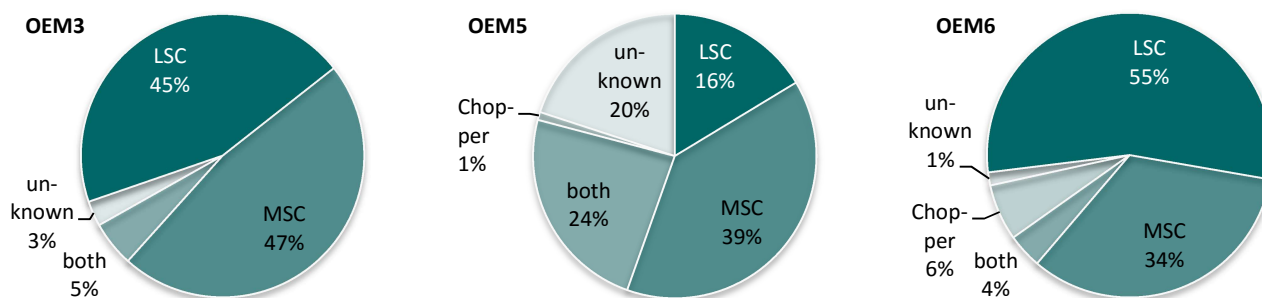

Fig. 8. Distribution of IGBT-module failures over machine-side converter (MSC), line-side converter (LSC) and chopper in DFIG-based wind turbines

question if fatigue damage might play a role at least in this group with older turbines. However, a detailed analysis of several field-returned IGBT modules from these oldest WT has revealed no indications of fatigue damage: The attachment of the bond-wires to the chips as well as the investigated die-attach solder layers were found in a good condition, which makes thermal-cycling induced fatigue an unlikely cause of converter failures also in WT of manufacturer OEM5.

#### E. Converter failure – a problem of aging fleets?

An important question in the context of this work is if high converter failure rates are an issue of older wind-turbine generations only or if this continues to be a problem in contemporary turbines. To shed light on this question, the turbine populations covered by the given data basis have been separated into three groups: wind turbines commissioned (a) until 2005, (b) during 2006-2010 and (c) during 2011-2015. Turbines with unknown year of commissioning are not included in this analysis. The average failure rates and the corresponding confidence intervals calculated for each of these three turbine generations are shown in Fig. 9 for both DFIG-based and EESG-based systems. Note that only failures of the phase module as the core component of the power converter are considered in this as well as in the subsequent analyses.

The analysis is carried out in two steps: In the first step, all phase-module failure data from the respective group of

turbines is included (see the darker-colored bars in Fig. 9). In this way, the analysis can be based on the largest possible amount of data. However, the drawback of this procedure is that the group of newest WT contains only data from the first years of operation (corresponding to the left-side part of Fig. 3) while the group of oldest turbines commissioned until 2005 covers data from the full range of WT ages and with that also from all phases of the so-called “bathtub curve”, i.e. early-failure, intrinsic-failure and deterioration behavior. As according to [8], [11] and [38], converters display early-failure characteristics, there is a risk that the different turbine-age range in the three groups systematically influences the result.

Therefore, in a second analysis step, only data from the 3<sup>rd</sup> to 6<sup>th</sup> operating year of each WT has been evaluated (cf. the lighter bars in Fig. 9), in order to guarantee a comparability of the failure-rate results. This procedure, in turn, has the disadvantage that it considerably reduces the amount of evaluated data, which leads to wider confidence intervals for the failure rates compared to the former case; for the group of EESG-based turbines commissioned 2011-2015, the remaining dataset becomes even insufficient for statistical evaluation.

Figure 9 gives a clear answer to the initial question: Converter failure is not a problem limited to older wind-turbine generations. Even if the phase-module failure rate of the newest EESG-based turbines is afflicted with a large uncertainty and should therefore be considered with caution, it can be stated that the converter reliability of contemporary

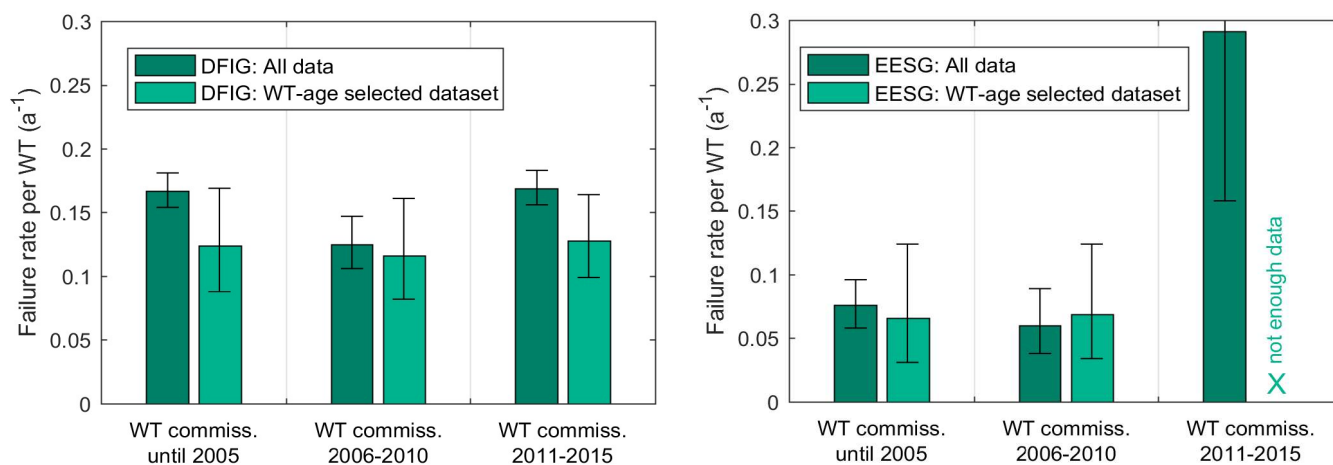

Fig. 9. Phase-module failure rates of DFIG-based and EESG-based wind turbines commissioned until 2005, during 2006-2010 and during 2011-2015

WT is not higher than that of WT commissioned 10-15 years earlier. As a matter of course, it should not be ignored that the average rated power of converters in WT has increased during this time, so that there are on average less failures per produced kWh. On the other hand, however, larger converters involve more expensive spare parts and logistics in case of failure and cause higher production (i.e. revenue) losses during WT downtime. The results obtained in this analysis are therefore nonetheless alarming and underline the urgent need to understand and eliminate the causes of converter failure.

#### F. Seasonal variation of phase-module failure rates

In search of the main causes and drivers of converter failure, temporal or spatial patterns in the failure behavior can often provide valuable indications. In order to identify a potential season-dependent clustering of failures, the average phase-module failure rates of WT fleets in different regions and climate zones are evaluated for each month of the year. All available failure data from the specific region and month is included in this analysis, so that e.g. the average failure rate obtained for the month of January is based on failures in January 2003, January 2004, ..., and January 2017.

A particularly clear seasonal clustering of failures is observed in the fleet in India, cf. the top left diagram in Fig. 10: Here, the phase-module failure rates during the months June to September are considerably higher than during the rest

of the year, with a maximum in August. A less extreme, but still clear seasonal clustering of failure is found in Scandinavia: According to the corresponding top right diagram in Fig. 10, the highest phase-module failure rates are observed during the months July to October. It is interesting to note that in case of the Scandinavian fleet, a clustering of phase-module failures in this season can be observed independently for WT of different designs and manufacturers. In other regions such as Germany, no similarly clear seasonal failure pattern is found. An interesting difference in this context is that the fleet in Germany is strongly dominated by WT with air-cooled converters while the investigated Indian and Scandinavian fleets use liquid-cooled converters.

The seasonal variation of the phase-module failure rate indicates that the local wind and / or climate conditions have a crucial influence on converter reliability. In the Indian fleet, the failure cluster coincides with the period of Monsoon, which is characterized by strong winds and heavy rains. In order to narrow down the potential influencing factors, the monthly average values of wind speed, relative humidity, ambient temperature and dew-point temperature have been identified for both the sites in India and Scandinavia. In case of the wind speed, these are determined directly from the SCADA data of WT in the respective region. The monthly values of humidity and temperature are derived from climate data by [39, 40] (Scandinavia, data from [34]) and [41] (India)

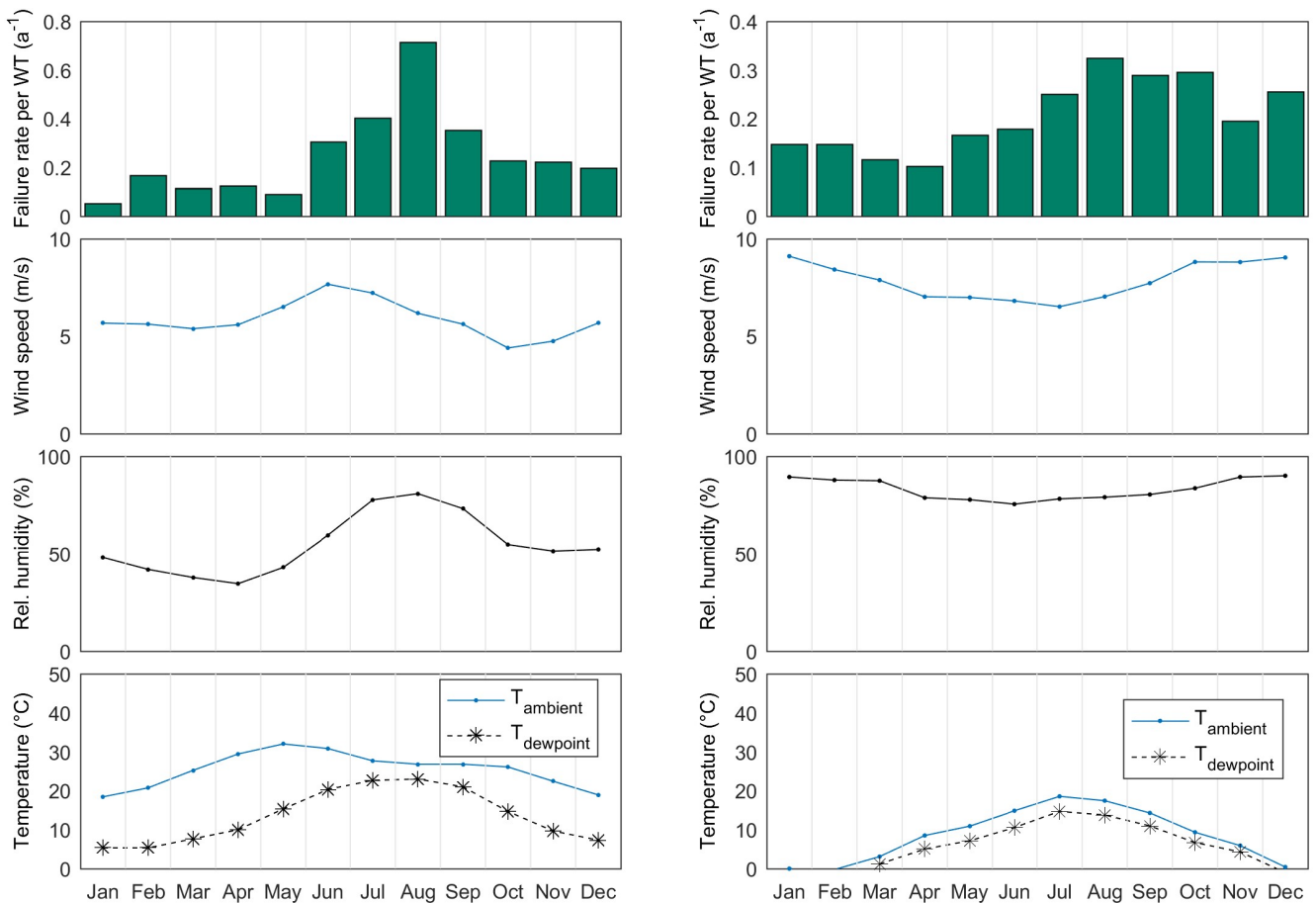

Fig. 10. Seasonal variation of phase-module failure rates in India (left, based on data from 590 WT operating years) and Scandinavia (right, 933 WT operating years) with corresponding monthly average values of wind speed, ambient temperature and relative humidity



by means of averaging over the regions of interest as well as over several years. Figure 10 shows the monthly average values of these quantities through the course of the year and allows a direct visual comparison with the phase-module failure rates.

In case of the Indian WT fleet, the highest average wind speed occurs in June. However, particularly high failure rates are found in August, when the average wind speed has already decreased considerably. Similarly, there is little correlation with the ambient temperature. In contrast, the excessive phase-module failures fall into the months with particularly high relative humidity (RH) and dew-point temperatures. In case of the Scandinavian fleet, there is a particularly strong correlation between failures and high values of the dew-point temperature. Here, in view of the much smaller variation of RH in Scandinavia compared to India, the dew point is predominantly determined by the ambient temperature (and with that the water vapor absorption capacity of the air). If there is a mostly unhindered air exchange between the ambient air and the interior of the WT and electrical cabinets, a high dew-point temperature in the ambient air results in a similarly high dew point inside the converter cabinet. Because of the fact that the temperature level of the converter components is mainly determined by the operating point and the settings of the cooling system, the risk of condensation in the power converter increases directly with the dew-point temperature. Therefore, the results shown in Fig. 10 provide a strong indication that humidity and condensation have a relevant influence on the emergence of phase-module failures. This is further supported by the frequent occurrence of converter failures during the re-start of WT after longer periods of downtime, which is widely reported from the field and which is likely to be caused by condensation (related to missing or insufficient converter pre-heating routines) [34, 1].

#### G. Influence of the WT operating point

Another question that can be investigated by means of a combined analysis of failure and operating data is, from which operating point the phase-module failures have occurred. For this purpose, the average active power in the 10min interval preceding failure is determined as described in Section II.C. For four groups of WT (with the group name indicating the generator concept and each group corresponding to a certain manufacturer), the distribution of phase-module failure events is plotted against the (normalized) active power, as shown in the upper diagrams in Fig. 11. It can be noted that failures do not only occur in the range of  $>0...100\%$  of the WT rated power. They are also observed in states, in which no power is fed into the grid or in which the 10min-average of the active power exceeds the rated power.

A particularly high number of phase-module failures is found in full-load operation as well as at low part-load operation and at  $P \leq 0$  kW. However, the sole evaluation of the absolute number of failures (or their distribution) over the active power is only of limited informative value because the operating time of a WT in each of the ranges or bins of active power differs considerably (cf. the diagrams in the middle of each subfigure of Fig. 11). This is closely related to the differing frequency distributions of wind speed at the different sites. In order to obtain a visual representation that allows

conclusions about the risk of converter failure in different operating points, for each bin the absolute number of failures is divided by the total operating time in this load range. This procedure results in a failure rate or failure frequency for each load bin, which is shown in normalized form in the diagrams at the bottom of the subfigures in Fig. 11.

If phase-module failure occurred fully independently of the WT operating point, the failure rate in all bins of active power should be approximately equal. However, the results in the lower diagrams in Fig. 11 show clearly that this is not the case. There is rather a common tendency in all considered groups of WT that the failure rate increases with the active power that the WT feed into the grid. (Note that in case of turbines with DFIG, this is not identical with the active power  $P_{\text{conv}}$  passing the power converter; see e.g. [28] for a presentation of the relation of  $P_{\text{conv}}$  and  $P_{\text{WT}}$  in a DFIG-WT.) The full-load operation is obviously afflicted with a higher risk of failure for the phase-module components than the operation at low part load. On closer inspection of Fig. 11, however, there are also major differences between the considered groups of WT: In the groups “DFIG2” and “IG+FPC”, the failure rates are particularly high in the range of  $>90...100\%$  of the rated power. In contrast, the group “EESG” stands out with an exceptionally high failure rate during operation above the rated power.

A final remark is that the analysis method applied in this section can provide useful results only if the number of failure events is high enough. The reason of this is that the lower the number of failures, the higher is the uncertainty and variation of the resulting failure-rate bar diagrams, so that a substantiated recognition of particularly failure-critical operating points is not possible. The diagrams shown in Fig. 11 are based on numbers of 45 to 245 phase-module failures per WT group.

## IV. CONCLUSIONS

With the objective to contribute to the identification of root causes and drivers of the frequent power-converter failures in wind turbines, this paper has presented the results of an in-depth analysis of failure and operating data. The underlying data basis covers in total  $\sim 7400$  operating years of 2734 variable-speed wind turbines of a multitude of manufacturers and types, operating at onshore and offshore sites on four different continents, which is to the authors' knowledge the to date most comprehensive converter-specific field-data collection in the world. Methodologically, the paper takes a step beyond previous failure-rate based analyses, on the one hand by quantifying the uncertainty of the provided failure rates by means of confidence intervals, on the other hand by combining failure and operating data to obtain deeper insights in the emergence of converter failure.

The study has investigated failures of the complete main power-converter system, which is defined to include – besides the power modules, their driver boards as well as the DC link capacitors and busbars as core components – the converter cooling system, converter control and filters, but also the main circuit breaker and the grid-coupling contactor. Within the converter system, the abovementioned core components, which are denoted ‘phase-module’ components, stand out with

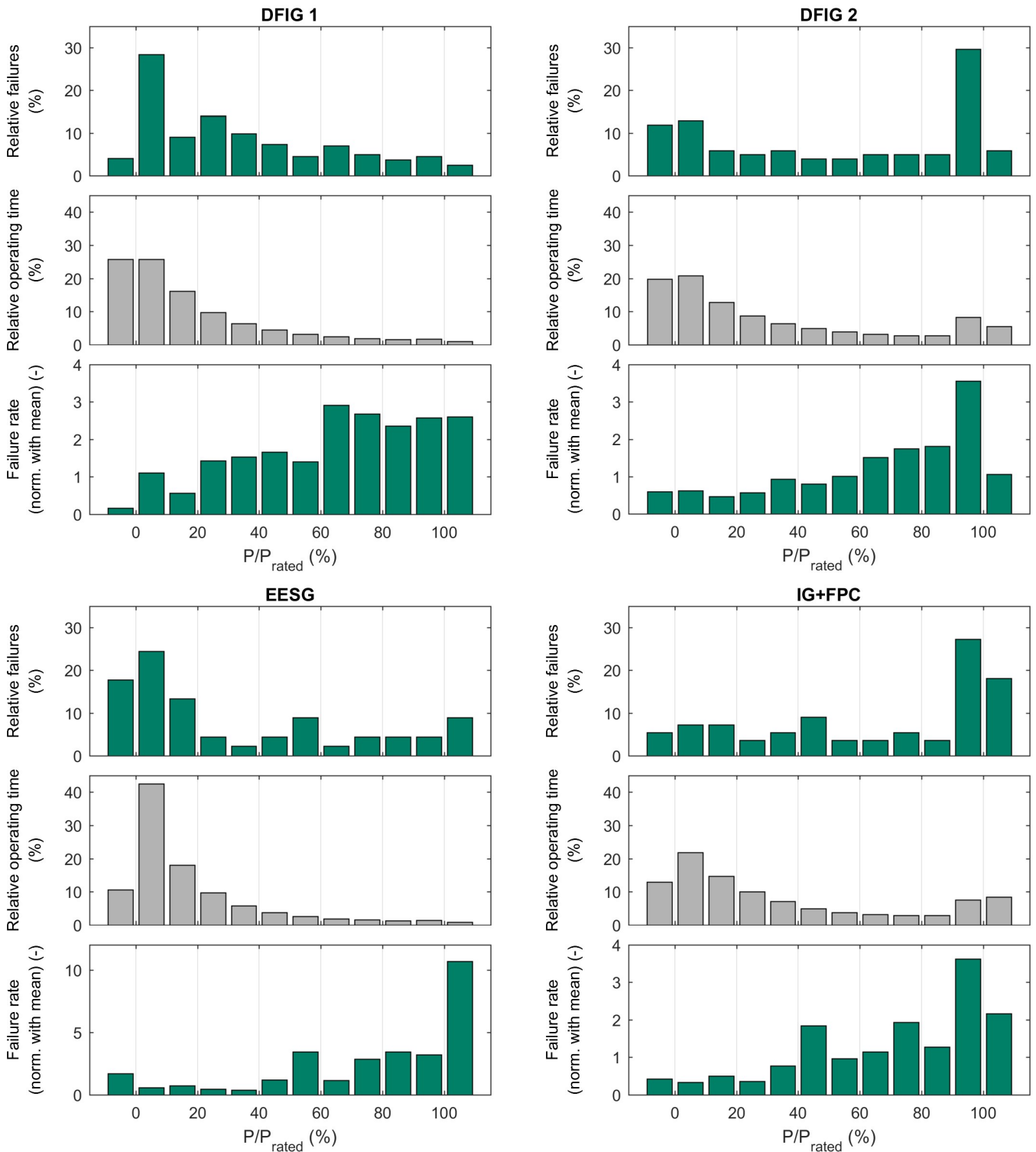

Fig. 11. Analysis of the operating point preceding phase-module failures for wind turbines of four different manufacturers (designation indicates the generator type); distribution of failure events over bins of active power (top), operating time (middle) and resulting failure rate (bottom) in each active-power bin

the on average highest portion of failures (neglecting the category “Other” with miscellaneous minor items). Due to the fact that this component category dominates also the annual average converter-related repair costs and downtimes, as a previous study of the authors had shown, the majority of

analyses in this paper have been focused on the phase-module category.

On average,  $0.48 \text{ a}^{-1}$  converter-system failures per WT have been observed in the investigated turbine fleet. Among these are  $0.16 \text{ a}^{-1}$  phase-module failures per turbine. The analysis has

revealed large differences between groups of WT with different generator-converter concepts: Among the compared concepts, the group of EESG-based WT stands out with the highest converter and phase-module reliability. It is followed by the group of WT with DFIG, while the considered WT with IG+FPC show the lowest phase-module reliability. Particularly interesting results have been obtained for DFIG-based WT, which according to the literature are widely considered to have a particularly high risk of converter failure due to the severe thermal cycling of the power semiconductors in their machine-side part: One is that the converters in DFIG-WT are not found in the last row with respect to reliability and that in fact very low phase-module failure rates have been found in DFIG turbines of certain manufacturers. The other interesting result in this context is that there are not generally more IGBT-module failures in the machine-side than in the grid-side converter of DFIG-turbines. These findings question the high failure risk of DFIG-converters postulated in the literature and with that also the underlying widespread assumption that accumulating thermal-cycling induced fatigue is the lifetime-determining mechanism in WT power converters. The observation that power converters in WT exhibit early-failure characteristics [38, 8, 11] instead of a degradation-dominated failure behavior and the fact that no signs of fatigue damage could be found in field-returned power modules of WT converters [35, 1] provide further important indications against the relevance of fatigue-based converter failures in this application.

Another important finding is the result that the converters and in particular the phase modules in WT of certain manufacturers achieve failure-rate levels as low as  $0.034 \text{ a}^{-1}$  per turbine, which proves that a relatively high reliability is in fact achievable with the existing modular 2-level IGBT-based low-voltage converter technology. Research should therefore prioritize understanding and learning from these differences in field-reliability levels before aiming at further chip-technology enhancements such as e.g. new materials for enhanced power-cycling design life.

A comparison of the failure rates of WT commissioned from 1997 to 2015 has shown that the problem of high converter failure rates is not limited to old fleets, but that the average phase-module reliability has not increased over the WT generations. This stresses the continued necessity to understand and eliminate the causes of converter failure also in contemporary wind turbines.

In search of factors promoting failure, the observation of a strong seasonal variation of phase-module failure rates in WT fleets in India and Scandinavian has revealed valuable indications: The finding that the months with high failure rates coincide with the periods of highest absolute humidity suggests that humidity and / or condensation play an important role in the emergence of phase-module failures. Finally, an investigation of the WT operating points preceding phase-module failures has shown that, in spite of certain WT-type specific differences, the risk of failure is highest during operation close to, at or (as observed in some WT types) even above rated power, i.e. under the impact of high electrical loading.

Subsequent work seeks to utilize the field data to investigate the effect of design factors and operating histories on

converter reliability, to link the data-analysis results with the findings of comprehensive post-mortem analyses of damaged components, and to derive on this basis recommended measures for enhancing the power-converter reliability in wind turbines.

#### ACKNOWLEDGMENT

The present work was carried out within the “Fraunhofer-Innovationscluster Leistungselektronik für regenerative Energieversorgung”. The support by the Federal State of Lower Saxony with funds from “Niedersächsisches Vorab” and by Fraunhofer-Gesellschaft is gratefully acknowledged. In addition, the authors thank their project partners for providing the comprehensive field data underlying this work.

#### REFERENCES

- [1] A. Bartschat, C. Broer, D. Coronado, K. Fischer, J. Kučka, A. Mertens, R. Meyer, M. Moriß, K. Pelka, B. Tegmeier, S. Weber and J. Wenske, *Zuverlässige Leistungselektronik für Windenergieanlagen (Reliable Power Electronics for Wind Turbines)*, Final project report of the Fraunhofer-Innovationscluster Leistungselektronik für regenerative Energieversorgung, Fraunhofer IWES, Ed., Stuttgart: Fraunhofer-Verlag, 2018.
- [2] Fraunhofer IWES, "Website of the Fraunhofer Innovation Cluster on Power Electronics for Renewable Energy Supply," [Online]. Available: [www.power4re.de/en](http://www.power4re.de/en).
- [3] V. Yaramasu and B. Wu, *Model Predictive Control of Wind Energy Conversion Systems*, Hoboken, NJ, USA: John Wiley & Sons, Inc., Feb. 2017.
- [4] K. Ma, *Power Electronics for the Next Generation Wind Turbine System*, Cham Heidelberg New York Dordrecht London: Springer, 2015.
- [5] J. B. Gayo, "Final Publishable Summary of Results of Project ReliaWind," 2011.
- [6] P. Matthews and T. Ahmad, "Improving Energy Yield Through Co-Ordinated Wind Farm Control," in *Presentation at the Wind Farm Data Management and Analysis Forum, 11-13 October 2016*, Hamburg, 2016.
- [7] F. Spinato and P. Tavner, "Reliability of wind turbine subassemblies," *IET Renewable Power Generation*, vol. 3, no. 4, pp. 387-401, 2009.
- [8] F. Spinato, *The Reliability of Wind Turbines*, Durham, UK: Ph.D. dissertation, Durham University, 2008.
- [9] S. Faulstich, B. Hahn and P. Tavner, "Wind turbine downtime and its importance for offshore deployment," *Wind Energy*, vol. 14, no. 3, pp. 327-337, 2010.
- [10] S. Faulstich, P. Lyding and B. Hahn, "Electrical subassemblies of wind turbines – a substantial risk for the availability," in *Proceedings of the European Wind Energy Conference EWEC 2010*, Warsaw, 2010.
- [11] J. Carroll, A. McDonald, O. B. Martin, D. McMillan and R. Bakhshi, "Offshore Wind Turbine Sub-Assembly Failure Rates Through Time," in *Proceeding of the EWEA 2015*, Paris, France, 2015.
- [12] J. Carroll, A. McDonald and D. McMillan, "Failure rate, repair time and unscheduled O&M cost analysis of offshore wind turbines," *Wind Energy*, vol. 19, no. 6, pp. 1107-1119, 2015.
- [13] J. Carroll, A. McDonald and D. McMillan, "Reliability Comparison of Wind Turbines with DFIG and PMG Drive Trains," *IEEE Transactions on Energy Conversion*, vol. 30, no. 2, pp. 663-670, 2015.
- [14] Y. Lin, L. Tu, H. Liu and W. Li, "Fault analysis of wind turbines in China," *Renewable and Sustainable Energy Reviews*, vol. 55, pp. 482-490, 2016.
- [15] C. Busca, R. Teodorescu, F. Blaabjerg, S. Munk-Nielsen, L. Helle, T. Abeyasekera and P. Rodriguez, "An overview of the reliability prediction related aspects of high power IGBTs in wind power applications," *Microelectronics Reliability*, vol. 51, pp. 1903-1907, 2011.
- [16] E. E. Kostandyan and K. Ma, "Reliability estimation with uncertainties

- consideration for high power IGBTs in 2.3MW wind turbine converter system," *Microelectronics Reliability*, vol. 52, p. 2403–2408, 2012.
- [17] M. Musallam and C. M. Johnson, "Impact of different control schemes on the life consumption of power electronic modules for variable speed wind turbines," in *14th European Conference on Power Electronics and Applications*, Birmingham, 2011.
- [18] M. Ikonen, Power cycling lifetime estimation of IGBT power modules based on chip temperature modeling, Ph.D. dissertation, Lappeenranta, Finland, 2012.
- [19] K. Ma, M. Liserre, F. Blaabjerg and T. Kerekes, "Thermal loading and lifetime estimation for power device considering mission profiles in wind power converter," *IEEE Transactions on Power Electronics*, vol. 30, no. 2, pp. 590-602, 2014.
- [20] M. Bohländer, Lastwechselstestbasierte Lebensdaueranalysemethoden für Leistungshalbleiter in Offshore-Windenergieanlagen (Power-cycling based lifetime analysis methods for power semiconductors in offshore wind turbines), Ph.D. dissertation, Chemnitz, 2014.
- [21] M. Held, P. Jacob, G. Nicoletti, P. Scacco and M. H. Poech, "Fast power cycling test of IGBT modules in traction application," in *Proceedings of the International Conference on Power Electronics and Drive Systems 1997*, 1997.
- [22] R. Bayerer, T. Hermann, T. Licht, J. Lutz and M. Feller, "Model for Power Cycling lifetime of IGBT Modules - various factors influencing lifetime," in *International Conference on Integrated Power Systems (CIPS)*, Nürnberg, 2008.
- [23] U. Scheuermann and R. Schmidt, "New Lifetime Model for Advanced Power Modules with Sintered Chips and Optimized Al Wire Bonds," in *Proceedings of PCIM Europe, 14-16 May 2013*, Nuremberg, 2013.
- [24] M. Bartram, I. v. Bloh and R. D. Doncker, "Doubly-fed machines in wind-turbine systems: Is this application limiting the lifetime of IGBT frequency-converters?," in *Proceedings of the 35th Annual IEEE Power Electronics Specialists Conference, 20-25 June 2004*, Aachen, 2004.
- [25] M. Bartram, IGBT-Umrichtersysteme fuer Windkraftanlagen: Analyse der Zyklenbelastung, Modellbildung, Optimierung und Lebensdauervorhersage (IGBT converter systems for wind turbines: Analysis of cycling stress, modeling, optimization and life prediction), Ph.D. diss., RWTH Aachen, 2005.
- [26] H. Wang, M. Liserre, F. Blaabjerg, P. d. P. Rimmen, J. Jacobsen, T. Kvisgaard and J. Landkildehus, "Transitioning to Physics-of-Failure as a Reliability Driver in Power Electronics," *IEEE Journal of Emerging and Selected Topics in Power Electronics*, vol. 2, no. 1, pp. 97-114, Mar. 2014.
- [27] L. Wei, R. Kerkman, R. Lukaszewski, H. Lu and Z. Yuan, "Analysis of IGBT power cycling capabilities used in doubly fed induction generator wind power system," *IEEE Transactions on Industry Applications*, vol. 47, no. 4, pp. 1794 - 1801, 2011.
- [28] F. Fuchs and A. Mertens, "Steady State Lifetime Estimation of the Power Semiconductors in the Rotor Side Converter of a 2 MW DFIG Wind Turbine via Power Cycling Capability Analysis," in *European Conference on Power Electronics and Applications (EPE)*, Birmingham, 2011.
- [29] R. Pittini, S. D'Arco, M. Hernes and A. Petterteig, "Thermal stress analysis of IGBT modules in VSCs for PMSG in large offshore Wind Energy Conversion Systems," in *Proceedings of the 14th European Conference on Power Electronics and Applications (EPE 2011)*, 2011.
- [30] S. D'Arco, T. Undeland, M. Bohländer and J. Lutz, "A simplified algorithm for predicting power cycling lifetime in direct drive wind power systems," in *Proceedings of the 9th Int. Multi-Conference on Systems, Signals and Devices (SSD)*, 20-23 March 2012, 2012.
- [31] C. J. Smith, C. J. Crabtree and P. C. Matthews, "Impact of wind conditions on thermal loading of PMSG wind turbine power converters," *IET Power Electronics*, vol. 10, no. 11, pp. 1268-1278, September 2017.
- [32] Q. Zhou, S. Xue, J. Li, C. Xiang and S. Chen, "Evaluation of wind power converter reliability considering multi-time scale and mission profiles," in *IEEE International Conference on High Voltage Engineering and Application (ICHVE)*, Chengdu, 2016.
- [33] S. Konrad, Ein Beitrag zur Auslegung und Integration spannungsgespeister IGBT-Wechselrichter (A contribution to the design and integration of IGBT-based voltage source converters), Ph.D. dissertation, TU Ilmenau, 1997.
- [34] K. Fischer, T. Stalin, H. Ramberg, T. Thiringer, J. Wenske and R. Karlsson, "Investigation of converter failure in wind turbines," Elforsk report 12:58, Stockholm, 2012.
- [35] K. Fischer, T. Stalin, H. Ramberg, J. Wenske, G. Wetter, R. Karlsson and T. Thiringer, "Field-experience based root-cause analysis of power-converter failure in wind turbines," *IEEE Transactions on Power Electronics*, vol. 30, no.5, pp. 2481-2492, May 2015.
- [36] K. Fischer and J. Wenske, "Towards reliable power converters for wind turbines: Field-data based identification of weak points and cost drivers," in *Proceedings of EWEA Conference, 17-20 November 2015*, Paris, 2015.
- [37] L. J. Bain and M. Engelhardt, Statistical analysis of reliability and life testing models: theory and methods, Dekker, 1991.
- [38] K. Pelka and K. Fischer, "Failure Behaviour of Power Converters in Wind Turbines," in *Proceedings of the 13th German Wind Energy Conference DEWEK, 17-18 October 2017*, Bremen, 2017.
- [39] Danish Meteorological Institute (DMI), Copenhagen, 2011.
- [40] Swedish Meteorological and Hydrological Institut (SMHI), Norrköping, 2011.
- [41] "Weatherbase," [Online]. Available: [www.weatherbase.com](http://www.weatherbase.com). [Accessed 1 June 2017].



**Katharina Fischer** received the Dipl.-Ing. degree in electrical engineering and the Ph.D. degree in mechanical engineering from Leibniz University Hannover, Germany, in 2002 and 2008. She was a Postdoctoral Researcher with the Chalmers University of Technology, Gothenburg, Sweden, until she joined Fraunhofer IWES in Hanover as a Senior Scientist in 2012. Her research interests include the reliability, condition monitoring and maintenance of wind turbines, with a particular focus on their power-electronic converters.



**Karoline Pelka** received the M.Sc. degree in mathematics from University of Münster, Germany, in 2015. Since 2016, she works as a Research Associate in the group Technical Reliability at Fraunhofer IWES in Hanover. Her research interests include statistical methods and models for reliability analysis of wind turbines.



**Arne Bartschat** received the M.Sc. degree in renewable energy systems from the HTW Berlin, Germany, in 2014. From 2014 to 2017, he worked as a Research Associate at Fraunhofer IWES with a focus on modeling and simulation of wind turbines and reliability studies of mechanical and electrical drive-train components. Since 2018, he is the head of the Large Bearings group of Fraunhofer IWES in Hamburg.



**Bernd Tegtmeier** received a Dipl.-Ing. degree in electrical engineering from the University of Applied Sciences in Lippe / Höxter, Germany, in 1997. He worked as a development engineer in different positions in the industry and at DLR in the field of military and aerospace engineering and subsequently for seven years at a German wind-turbine manufacturer. Since 2014, he is a Research Associate at Fraunhofer IWES, with a main focus on power converters, nacelle instrumentation and testing, and electrical certification.



**Diego Coronado** received a double degree in mechanical engineering from the Ecole Nationale d'Ingénieurs de Metz in France and the Universidad Tecnológica de Pereira. He has a master degree in renewable energy from Mines ParisTech in France. He worked as a Research Associate for Fraunhofer IWES for 5 years doing research in the field of condition monitoring for wind turbines. He worked as a service and diagnosis engineer at OELCHECK GmbH and he is now a mechanical and operation engineer at CGN Europe Energy in Paris being responsible for the supervision of wind farms including condition monitoring and asset management.



**Christian Broer** studied mechanical engineering at Leibniz University Hannover, Germany, and received the Dipl.-Ing. degree in 2005. Subsequently he worked as a Research Associate at the Institute of Materials Science of the same university. For several years he worked in different positions in the industry dealing with R&D of power electronics and satellite instrumentation. In 2012 he joined Fraunhofer IWES and leads the department Reliability and Validation in Hanover and Hamburg, Germany, since 2014.



**Jan Wenske** received the Dipl.-Ing. degree in mechanical engineering and the Ph.D. degree in electrical engineering from Technical University of Clausthal, Germany, in 1994 and 2000. For several years he worked in different positions in the industry. Since 2011 he is head of the wind-turbine and system-technology department and deputy director of Fraunhofer IWES in Bremerhaven. Since 2013, he is Professor for wind-turbine technology at University of Bremen, Germany.