



**ANNUAL REPORT**  
**2008**

Annual Report of the  
Fraunhofer-Institut  
für Mikroelektronische  
Schaltungen und Systeme IMS  
Duisburg  
2008



In its 24<sup>th</sup> year, the Fraunhofer IMS underwent a strategy process. New departments such as the Department of Sensors and Actuators were established. Contract volume showed a very positive trend, particularly with respect to the development of medical implants and transponder systems.

The operating budget increased by 16 % over the previous year to 19,9 million €. The slowdown of the global economy had small effect in 2008. Although the upheavals on the national and international markets are not yet over, the Fraunhofer IMS has long-term contracts but it is a challenge to make a safe assumption of the revenues in 2009.

We expect to see growth in revenues and in the number of projects as a result of inHaus2, which we inaugurated on November 5, 2008. Directed by Mr. Scherer, nine Fraunhofer Institutes are working at the Fraunhofer inHaus Center to define the future of commercial properties. **NextHotelLab**, **nextHealth&CareLab** and **next-OfficeLab** are the central application laboratories for the hotel and event sector, for the hospital and nursing home sector, and for the office and service sector respectively. Prototypes are being developed, tested, optimized and marketed in Duisburg in collaboration with our commercial partners, while market research and consumer acceptance research is also being conducted.

The planned extension to the CMOS production facility is almost completed, and the number of wafer starts was significantly increased from 70 in 2007 to over 100 in 2008. The production capacity linked to our cooperation with ELMOS AG has thus been sustainably improved.

The ongoing development of new applications produced three spin-offs from the IMS in 2008, following the usual Fraunhofer model. "TriDiCam" is a company that develops robust 3-D sensor modules. "Angiocam" produces cameras that can see through opaque liquids such as blood. The third start-up company, "Future Chemistry", works on microreactors used in the chemical and other industries and is located in Nijmegen (Netherlands).

IMS researchers were awarded the 2008 Joseph-von-Fraunhofer prize for a unique eye implant. The wireless and battery-free optical prosthesis, which is fully implanted in the eye, gives blind patients the ability to perceive simple visual impressions. This development takes us a significant step closer to realizing the vision of enabling blind people to recover their sight. The plan for 2009 is to develop the implant to production readiness for our industrial partners.

The international IMS CMOS Imaging Workshop – which was attended by

researchers, developers and image sensor experts from all over the world – took place at the Fraunhofer IMS for the fourth time in 2008. The exchange of technical experience between participants was a primary focus of the biennial meeting.

Particularly I would like to thank our highly motivated employees who contributed to these remarkable results in 2008 by their dedicated work and their outstanding knowhow. They have helped to lay the foundations for future success in a time of rapidly changing markets.



Anton Grabmaier



# Contents

Profile of the Fraunhofer Institute IMS	7
Fraunhofer IMS Business Fields and Core Competencies	11
Development of the IMS	19
<b>Selected Projects of the Year 2008</b>	
<b>I CMOS Devices and Technology</b>	
Modeling of High-Voltage Transistors J. Pieczynski, I. Doncov	24
CMOS processes for optical devices D. Durini, A. Spickermann, M. Jung	27
<b>II Silicon Sensors and Microsystems</b>	
Intravascular monitoring system for hypertension P. Fürst, M. Görtz, H. K. Trieu	33
Nanopotentiostat for portable electrochemical measurements T. van den Boom, P. Fürst	35
<b>III CMOS Circuits</b>	
Microelectronics for High Temperature Applications R. Lerch	39
Analog and Mixed-Signal ASICs H. Kappert, R. Kokozinski	42
Readout concepts for uncooled microbolometers D. Weiler, D. Würfel	44
<b>IV Wireless Chips and Systems</b>	
Wireless Sensor and Actuator Networks H.-C. Müller	48
Feasibility of Deeply Implanted Passive Sensor Transponders in Human Bodies A. Henning, G. vom Bögel	50

# Contents

## V Systems and Applications

Micro-Reactor Systems R. Klieber, B. Heidemann, H. K. Trieu	56
inHaus2 – Intelligent construction site logistics F. Meyer, G. vom Bögel	58
List of Projects IMS	65
List of Publications and Scientific Theses 2008	71
<b>Chronicle</b>	
New Trends in CMOS Imaging at Fraunhofer IMS C. Metz	81
Opening Inhaus II S. van Kempen,	82
Fraunhofer Preis 2008 – Retina Implantat H. K. Trieu	85
Trade Fair Sensor und Test C. Metz, Trieu	86
New Trade Fair Presentation W. Brockherde, C. Metz	87
inHaus at the Federal Chancellery of Germany S. van Kempen	88
Press Review	91

# Profile of the Fraunhofer IMS



The Fraunhofer Institute of Microelectronic Circuits and Systems (IMS) was established in Duisburg in 1984. The Fraunhofer IMS is, through continued growth and innovative research and development, one of the leading institutes in Germany for applied research and development in microelectronic and CMOS-technology.

The Fraunhofer Institute of Microelectronic Circuits and Systems (IMS)



200mm-CMOS-cleanroom

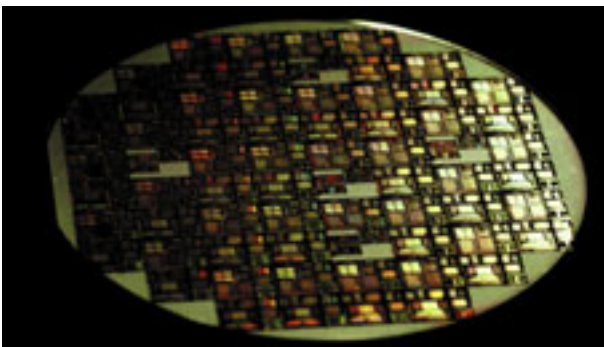

Multi-project-wafer

## Fraunhofer IMS

Employees	203
Budget	17 Mio. Euro
Industrial Projects	50 % of Budget
Public Projects	35 % of Budget
Fraunhofer Projects	15 % of Budget

## Infrastructure

The IMS offers a wide range of services and production of in silicon based devices and systems.

The fabrication takes place in class ten cleanrooms, wafer testing rooms and an assembly-line with together more than 1600 square meters.

## Fraunhofer IMS Wafer Fab

Wafer size	200 mm (8 inches, 0.35 $\mu$ m)
Cleanroom area	1300 square meters
Cleanroom class	10
Employees	app. 90 in 3 shifts 7 days a week
Capacity	> 70.000 wafer/year



## IMS-Production and Development

The Fraunhofer IMS develops, produces and assembles smart sensors, integrated circuits and discrete elements (ICs and ASICs). It also offers the fabrication of devices on a professionally managed CMOS production line in small to medium quantities.

Our know-how has been applied in shavers for Braun, a self-ballasted lamp for Osram and many other applications for customers from every field of industry.

The ICs are assembled in the cleanroom (400 square meters) of the Fraunhofer IMS assembly facility. This facility supports the production of ICs in ceramic packages or as COB (Chip on board, COB). COB assembly is available from small quantities to several million units per year.

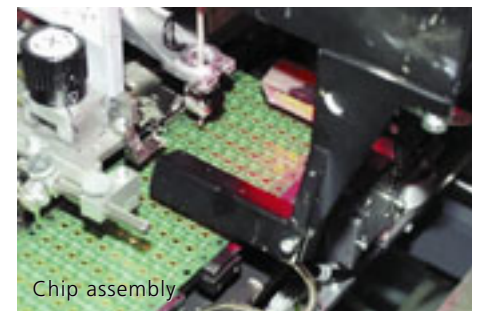
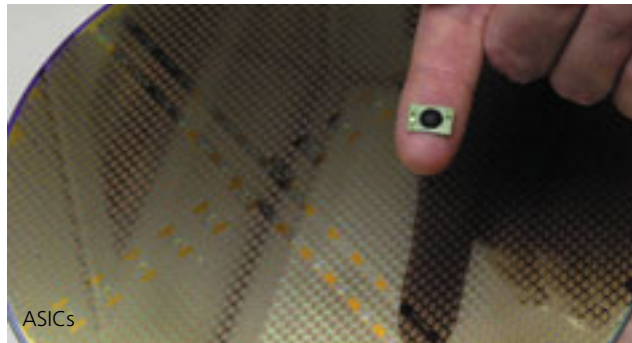

## Supply and Service

The Fraunhofer IMS offers R&D services tailored to our customer needs, providing efficient solutions ranging from the initial studies to the series products.

Cooperation possibilities:

- studies and feasibility studies
- consulting and concept development
- demonstrator and prototype development
- chip production (ASIC Production)
- development of soft- and hardware

## From idea to production

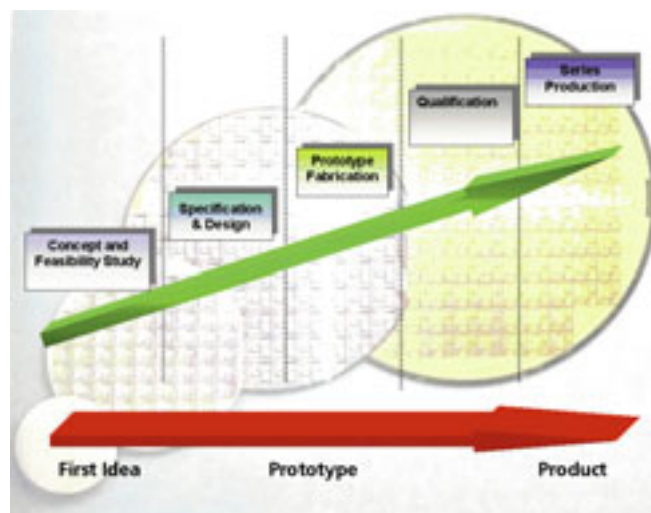



# Fraunhofer IMS Business Fields and Core Competencies

# Research and Development at the Fraunhofer Institute for Microelectronic Circuits and Systems

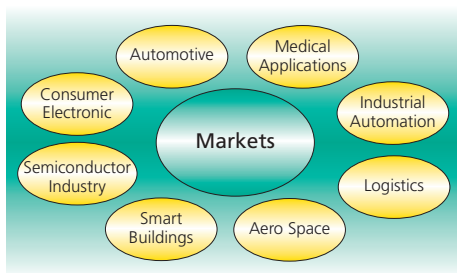

The Fraunhofer IMS conducts research and development in many different application areas of including

- Automotive
- Medical
- Consumer
- Smart Buildings
- Communication
- Aero Space
- Logistics
- Industrial Automation
- Semiconductor Industry

These applications are served by our business fields:

- CMOS process and assembly
- CMOS sensors (image, pressure and temperature sensors)
- Smart Buildings
- Embedded systems hardware and software
- ASIC design und development
- Wireless systems, ICs and transponders

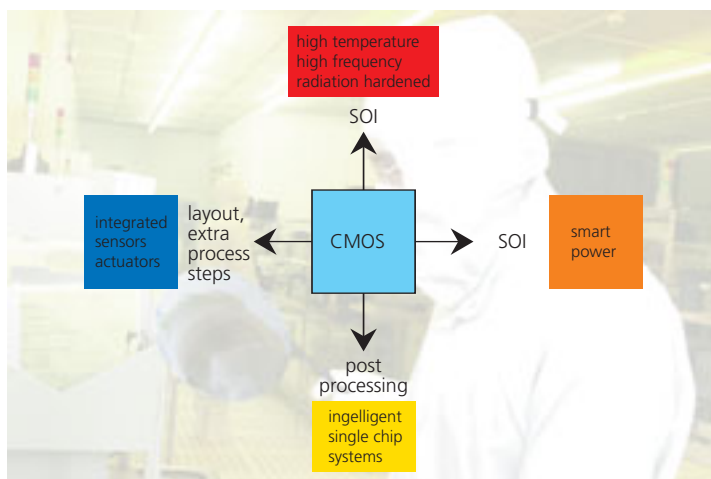

## 1. CMOS Process and Assembly

Based on standard CMOS process technology, IMS develops customer-specific processes and special options for standard processes (e.g. capacitors, polysilicon and thin-film resistors, high voltage transistors, EEPROM, OTP and several types of sensors).

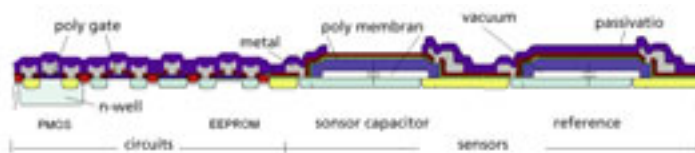

## Pressure-Sensor-Process

With a clear view on the needs of a rapidly growing sensor market, IMS leveraged its long experience in research and development of CMOS-compatible integrated sensors to establish micro-mechanical pressure sensors as one of its product lines.

## On-Chip Integration of CMOS Circuit and Sensor Elements

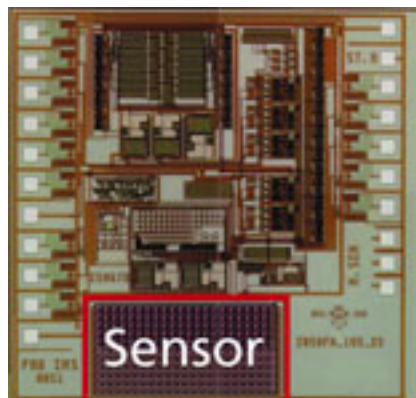

At the heart of this product line lies a pressure sensor that is integrated into standard CMOS technology. This micro-mechanical pressure sensor was designed for a large range of pressures, and can be monolithically integrated with a plethora of electronic devices, e.g. MOSFETs, capacitors, resistors or EEPROMs. The layout of the pressure sensor determines its pressure range, as the membrane's stiffness is directly related to its diameter.

### High Temperature SOI CMOS Process

The high temperature SOI CMOS process uses SOI substrates for the production of ASICs that operate at temperatures of up to 250° C.

Only fully CMOS compatible process steps are used to manufacture not only standard CMOS circuit elements, including EEPROM, but also silicon based sensors, actuators and power devices.

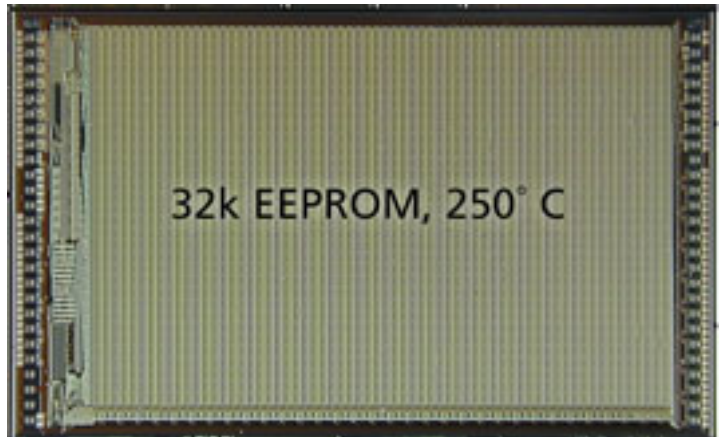

### Power Devices

In close cooperation with industrial partners, Fraunhofer IMS provides a 600V-CMOS-process for half- and full bridge driver chips for IGBTs. Also a novel discrete power MOS transistor process based on trench technology has been developed at IMS. It features an ultra low on-resistance so that transistors with less than 1 mOhm on-resistance can be realized on a small die, while keeping the number of process steps low. Such low loss switches are used in power supply, automotive and other low voltage applications.

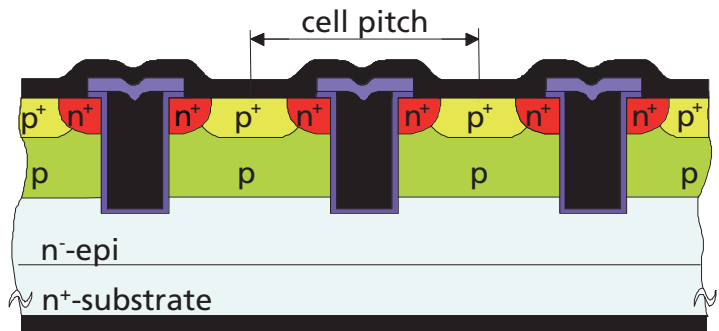

### CMOS Fabrication

Fraunhofer IMS provides numerous semiconductor production services in its 200 mm CMOS production line. The professionally managed class 10 clean room has more than 1600 m² floor space. The 24 hour, 7 days a week operation ensures the uniform quality of our products.

The Fraunhofer IMS production line especially caters to the production of smaller and medium quantities of ASICs. The production line operates under an ISO 9001:2000 and TS 16949 certified quality management system, assuring stability and reliability of products and production. Timely, reliable and customer-oriented production is our and our customers key to success.

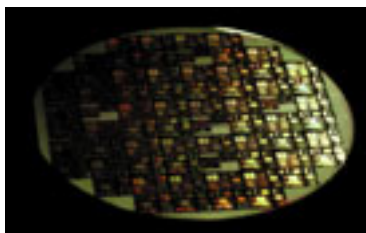

## 2. Sensors

### Pressure and Temperature Sensors

The basic element of our pressure sensors is a micromechanical sensor that is fabricated using standard CMOS processing equipment. These sensors can be realized for a wide range of pressures, sharing a single chip with all electronic devices available in a CMOS process, e.g. MOSFETs, capacitors or EEPROMs. The sensors can be configured as absolute or as differential pressure sensors, both with capacitive readout. The necessary signal conversion, linearization and amplification circuits are realized on the same chip, effectively eliminating interference on sensor wiring that is a major issue for discrete solutions. We have already created a variety of innovative products using this monolithic integration of sensors and signal processing functions like programmable amplifiers, sensor linearization, temperature compensation or wireless interfaces.

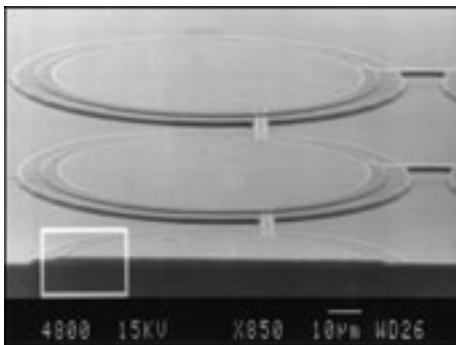

The layout of the sensor element determines its pressure range, which may be situated between 0.5 to 250 bar, as the sensor diameter controls the stiffness of the membrane: Smaller and stiffer membranes shift the pressure range to higher pressures. Thus the sensors are suitable for the measurement of pressures ranging from blood, air, and tire pressure all the way to hydraulic oil pressure. The small size of the sensor

and its associated electronics enables innovative medical applications for the in vivo measurement of the pressures of blood, brain, eye or other body fluids.

### CMOS Image-Sensors and Sensor System

Fraunhofer IMS image sensors are based on CMOS technology, which enables the monolithic integration of sensor and circuit elements on a single chip. This integration is used e.g. to control the sensitivity of each individual pixel to avoid blooming.



CMOS Image sensor



CMOS Camera

A wide range of CMOS image sensors has been developed for our customers and in research projects. The realized sensors include high dynamic range sensors, high speed sensors – which deliver 1000 high quality images per second – low power sensors with less than 40 mW of power consumption and high-resolution sensors with “region of interest” function for faster readout of subsections of the pixel array.

The CMOS image sensors suppress smearing and blooming effects and always deliver sharp images. Their electronic high-speed shutters enable the realization of 3D imagers.



Comparison of images taken with CCD (left) and CMOS (right) cameras

Our customers, among them BMW AG, Siemens VDO and EADS, use our know-how for concepts and designs of CMOS image sensors.

A newly established field of research and development now extends the spectral range of our imagers into the far infrared (FIR, 8–14  $\mu\text{m}$ ). This will be achieved with microbolometer arrays that are integrated on a CMOS chip. Packaged in an evacuated case with IR-transparent lid for thermal insulation these sensors will open up a new window to the world, providing a new solution for many applications.

### 3. Smart Buildings Embedded Systems Hardware and Software

#### InHaus1: The Innovation Workshop for Private Homes and the Housing Industry

After a successful first phase 2001 to 2006, the internationally acclaimed inHaus1 home innovation facility has now started its second operating stage. In the living laboratory and workshop area we have developed in close co-operation with users and research, service and industrial partners, networked systems solutions for private homes and the housing industry. These



InHaus 1

systems use new technologies to save energy, increase security, provide support for senior citizens and sick people, and generally improve life at home. Our spin-off inHaus GmbH has realized more than 100 smart home systems since 2004, for the housing industry and private home owners in both new home and home upgrade projects.

#### InHaus2: The Innovation Workshop for Commercial Buildings

In March 2007 began the construction of the inHaus2 research facility. This research platform for modern commercial buildings will provide a realistic environment for the development, deployment and testing of innovative techniques and products. The main R&D objectives are operating cost reduction and workflow optimization in commercial buildings. Right from the beginning new techniques will be implemented to optimize the construction process of the inHaus2 facility itself, e.g. using RFID-tags collecting data which will give information for facility management later on.

In different sectors of the inHaus2-facility, new systems solutions for future hotels, hospitals or retirement homes will be put to the test. Another field of research is offices that adapt to the user's behavior.

The inHaus Center offers R&D and complete systems-solutions to builders, modernizers or operators of homes and commercial buildings, to implement complete electronic and ITC systems for new and added value functions. This includes the following aspects:

- Safety and security
- Multimedia
- Support for the elderly
- Energy saving
- Light management



InHaus 2

#### 4. ASIC Design and Development

The development of analog, digital and mixed analog-digital integrated systems is a core competence of Fraunhofer IMS. Application specific integrated circuits (ASICs) enable our customers to provide cheaper and more powerful products. We offer the full spectrum from custom to IP-based ASIC solutions.

Full-Custom ASICs are designed from scratch to accommodate the specific requirements of the customer, providing a highly optimized product. The IP-based ASIC is based on proven generic components, with lower design time and cost. Using a mix and match approach both design styles can be combined to leverage the benefits of both.

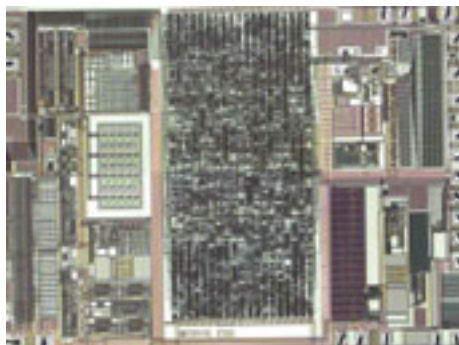

Fraunhofer IMS  
ASIC with integrated pressure sensors

The close co-operation with our in house CMOS production line provides a seamless and efficient path from concept to series production. Our long experience in the development of integrated circuits, starting from concept through design, layout, and fabrication to testing ensures a short development time and a minimized design risk.

Our fields of design expertise are:

- Embedded microcontroller, IP-cores
- High-temperature ASICs
- Smart power integration
- Non-volatile memories
- Mixed-signal design
- Sensors and sensor signal processing
- RFID and transponders
- Wireless systems and radio frequency circuits
- Wireless sensor networks

Beside standard ASIC solutions for all kinds of applications, ASICs with sensors and sensor signal processing integrated on a single chip have been realized.

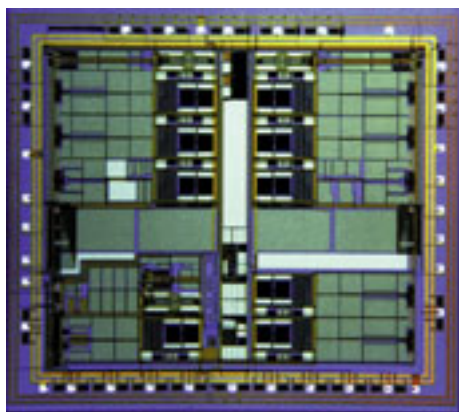

Fraunhofer IMS  
CMOS ASIC

These ASICs often combine our core competences in ASIC design,

- System-on-Chip (SoC) solutions with micro system technologies,
- Mixed-signal signal processing and
- Integration of RF building blocks for wireless energy and data transfer.

These wireless and transponder based micro systems including integrated sensors are challenges for modern micro electronic and micro system technologies. Our customers benefit from our research in these areas, which provides viable solutions for their applications – applications that demand miniaturization, energy-efficiency, cost-optimization and reliability.

#### 5. Wireless Systems and Transponders

A core-competence of Fraunhofer IMS is the development and realization of wireless systems. Research and development focuses, among other things, on wireless sensor networks. These networks comprise autonomous sensor modules that are distributed over a large area or volume, and measure physical, chemical and other quantities. The measured values are transferred to a central agency, making use of intermediate nodes for data transfer, or they can be used by similarly distributed actor modules for decision-making and control processes.

Development in this field includes new methods for communication (e.g. protocol stacks, localization) and the realization of cost-efficient, miniaturized components. The realization of new products in an efficient and timely manner is facilitated by the use of modular hardware and software components that allow a quick adaptation to application requirements.

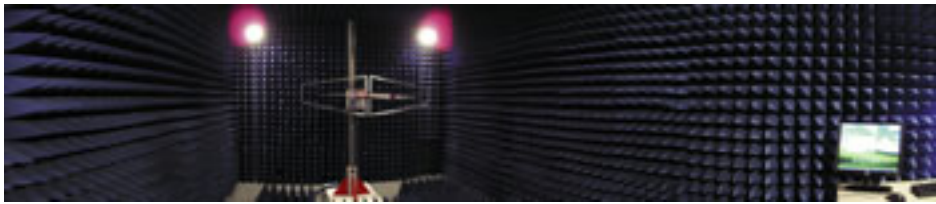

High-frequency measurement chamber at Fraunhofer IMS

The advantages of wireless sensor networks were successfully demonstrated in various projects addressing a variety of environments.

Important applications of **wireless sensor networks** are in the field of:

- Industrial automation, e.g. logistics and inventory control.
- Agriculture e.g. monitoring of air and soil parameters.
- Facility management, e.g. remote monitoring of buildings and infrastructure elements.



Sensor-network in green house

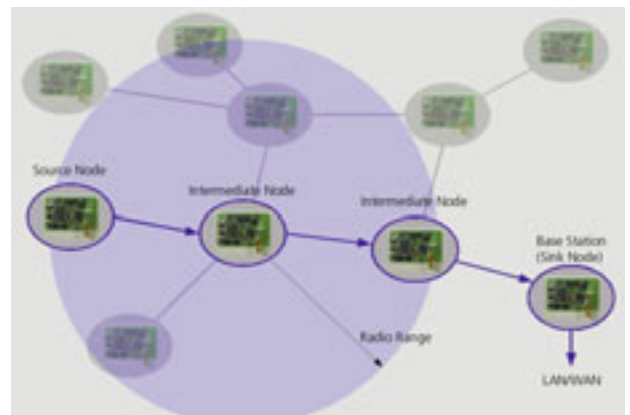

Topology of wireless Sensor-networks

Our customers face a number of challenges that are addressed by our R&D activities. One set these activities addresses tools for network development, deployment and maintenance. Others address the field of energy harvesting, the ability to extract module power from the environment and obviating the need for batteries or power cables.

The **transponder systems** unit at the Fraunhofer IMS offers system solutions for the integration of novel portable or stationary transponder read-write devices and base stations into smart network-systems.

It also provides base stations for transponder ASICs with integrated micro sensors developed at Fraunhofer IMS, thus offering complete system solutions.

These transponder systems are used in smart buildings and vehicles, industrial automation, medical devices and logistics.

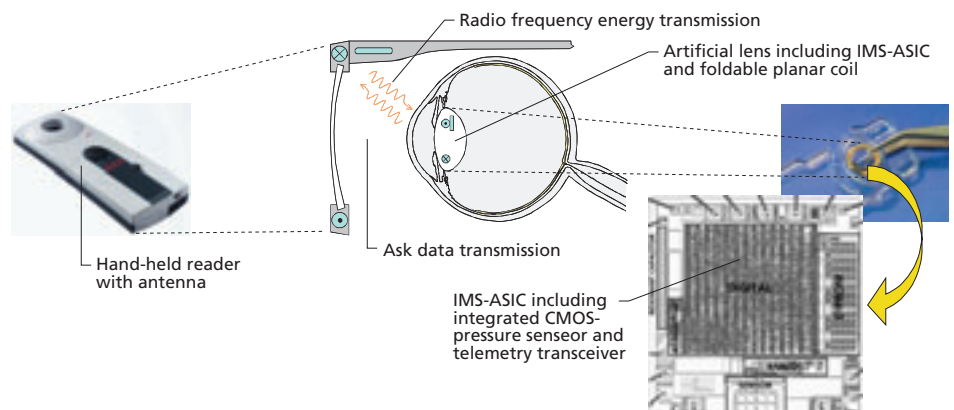

Transponder System Example: Intraocular Pressure Measuring System



## Development of the IMS



# Development of the IMS

Budget IMS

24 Mio. Euro

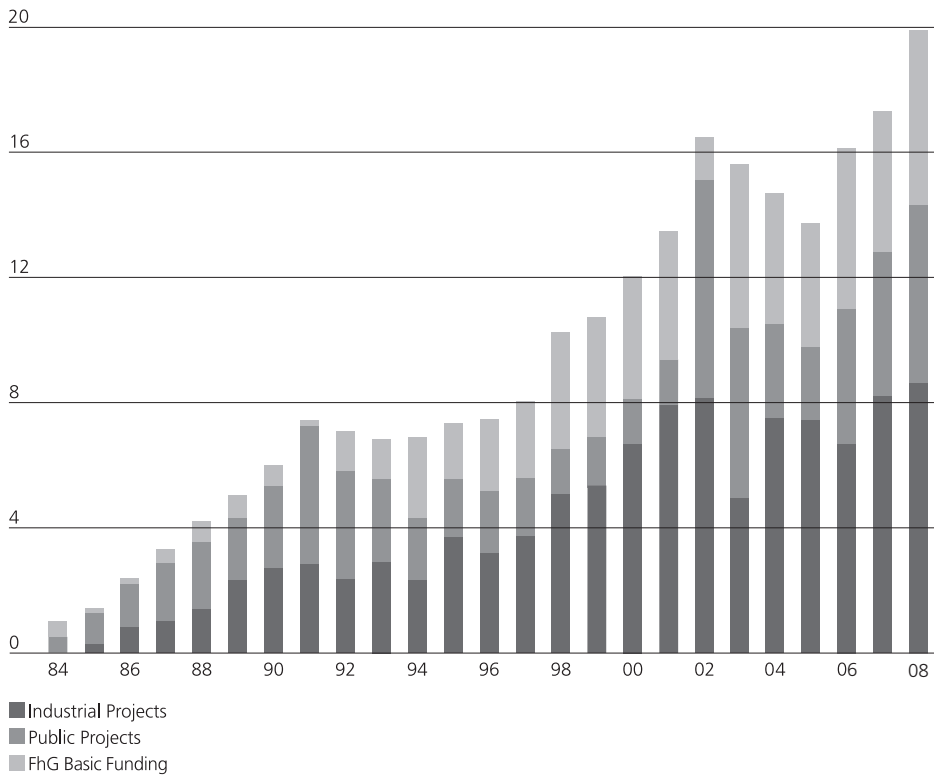

Staff Members IMS

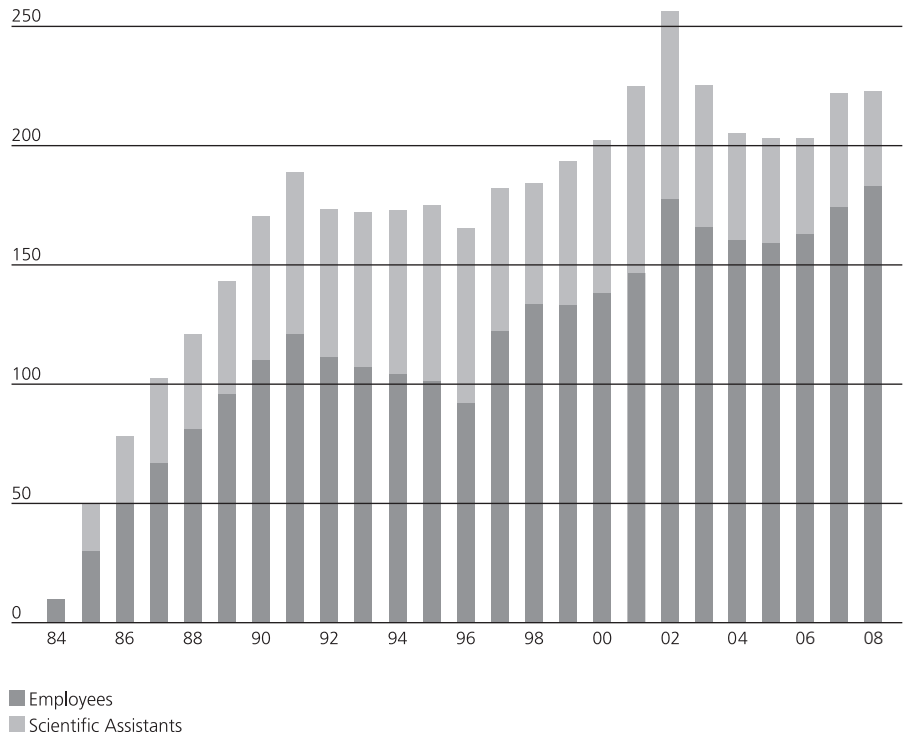

Capital Investments IMS

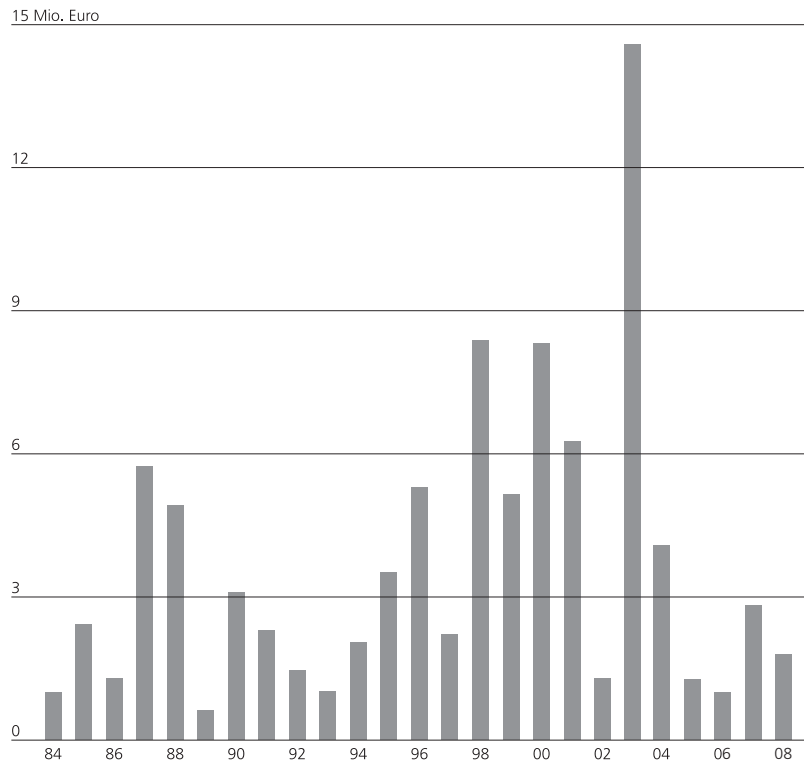

## Selected Projects of the Year 2008

## INTRODUCTION

In this report we present a procedure for modeling high-voltage NMOS transistors from the IMS 1.2um CMOS/pressure sensor process.

Generally, two different approaches can be used for modeling a complex device such as a high-voltage transistor.

The first approach involves using commercial compact models. The most popular HV-models today are: Synopsis HSPICE CMOS High-Voltage Model, Simucad LDMOS and HVMOS, Philips MM20 or HVEKV. Unfortunately, these models are not implemented in the standard simulation and extraction software environment (e.g. SPECTRE, ICCAP) and they are expensive.

The second solution for device characterization – which is also the approach presented here – is the use of standard models with sub-circuit extension (the so-called macro-models). As a standard model, our institute chose to select the well known and robust Berkeley **BSIM3** MOSFET model (besides HV-NMOS, this model has also been used for digital, natural, well-in-well and EEPROM transistors). BSIM3 provides an optimal fit to the underlying process and shows a good mathematical behavior with respect to convergence. To include the missing HV-specific effects, such as drain extension, quasi-saturation and self-heating we implemented a **sub-circuit extension**. [1]

## HV NMOS TRANSISTOR

Our high-voltage NMOS transistor consists of highly doped drain and source regions, a low doped drain extension region (length 6μm), transistor channel and poly-silicon gate. A simplified cross-section of the device and also typical transistor output curves are shown in Fig.1. In the curve graph, the “problematic” regions related to the self-heating effect and quasi-saturation are indicated.

Initially, we attempted to model the HV NMOS transistor using a pure BSIM3 model (see Fig.2). However, as we expected, the simulated curves did not match the measured curves, particularly in the pinch-off and saturation regions. In the next section, we describe how we extended the BSIM3 standard model to take into account the high-voltage effects, and thus achieved a better fit between the simulation and measurement.

## MODELING OF DRAIN EXTENSION AND SELF-HEATING EFFECT

Drain extension is the main driver of the **quasi-saturation effect** [2,3]. This effect becomes particularly evident for short NMOS transistors where, at high gate voltage, drain current does not increase proportionally to the gate voltage. Due to a drift region in the drain extension, drain current tends to be saturated first not because of channel pinch-off at the drain end, but rather because of the carriers velocity saturation in the drain extension region.

To model this effect, we used a MES-DRIFT structure designed by Alcatel Microelectronic (see transistor cross-section in Fig. 3). Our HV transistor was divided into an intrinsic MOSFET region

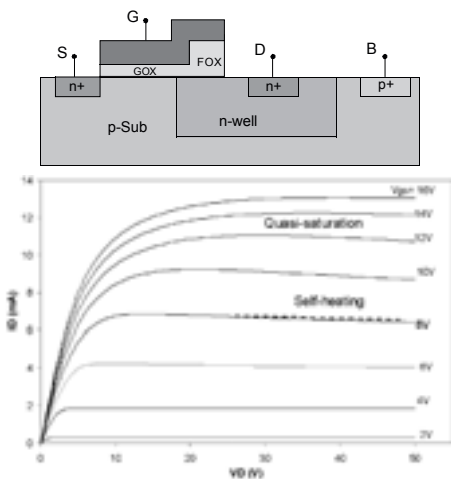

Figure 1: A typical NMOS high-voltage transistor

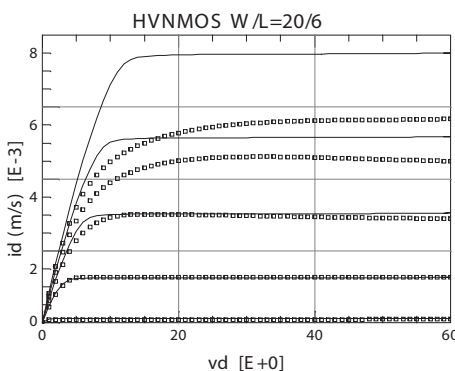

Figure 2: Results of simulation with standard BSIM3 (dots=measurement, line=simulation)

and a drift region (i.e. drain extension). The intrinsic transistor region was thus represented by the standard BSIM3 model while the drift region was modeled using an additional bias dependent resistor.

To accurately model the resistor, we first considered the effects of gate-induced charge accumulation and body voltage-induced depletion. Additionally, we modeled the effects of carrier velocity saturation in the drift region by making the drift resistance directly dependent on the electric field applied to the drift region ( $V_d - V_k$ ).

The **self-heating effect (SHE)** is observed in a transistor when its output conductance turns negative at high drain and high gate voltage (see Fig. 1). This effect occurs because the high power dissipated in the HVMOSFETs increases the internal device temperature, which affects mobility, threshold voltage and velocity saturation, leading to a lower transistor current [4].

The SHE was described in our model by a standard thermal sub-circuit that includes thermal resistance  $R_t$  and a thermal capacitor  $C_t$  (see Fig. 4). The power dissipation  $P_d$  of the transistor was injected into the RC sub-circuit as the current  $I = P_d = V_d * I_d$ , resulting in a voltage drop  $V(5,0)$ . This voltage drop is proportional to  $P_d$  and represents the internal heating rate of the device  $\Delta T$ . The impact of  $\Delta T$  on the transistor's drain current (reducing the effective drain current) was subsequently modeled by an additional sub-circuit current source  $I_{she}$ .

## EXTRACTION

All the measurements, extractions and optimizations were performed using the standard ICCAP software package with a BSIM3 AdMOS extension.

To perform the measurements we used an automated test system shown in Fig. 5. The system consisted of a semi-automatic prober, a DC measurement unit, switching matrix and a CV meter. All the units were controlled from a PC running the ICCAP software. This set-up enabled us to conduct fully automated DC and CV measurements of all our transistors (about 10 devices with different widths and lengths) and auxiliary structures (special capacitors, diodes, etc.). The measurements were carried out under three different temperatures:  $-40^\circ\text{C}$ ,  $+25^\circ\text{C}$  and  $+125^\circ\text{C}$ .

## RESULTS AND VERIFICATION

For verification, we implemented the above model in the ICCAP and SPECTRE software environment. We then first compared the measured and simulated curves of a single short transistor (see Fig.6). In doing so, we were able to obtain a particularly good fit in all of the transistor's operating regions. Using the drift resistor model resulted thereby in a proper model of the linear and pinch-off regions. Introducing the SHE model yielded a good fit of the  $I_d V_d$  and conductance ( $G_{DS}$ ) curves in the saturation region. Of particular importance was thereby proper modeling of two characteristic conductance "zero points" (i.e. points where the  $G_{ds}$  changes its sign).

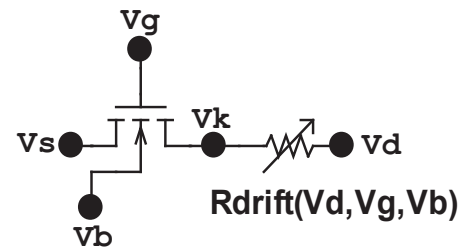
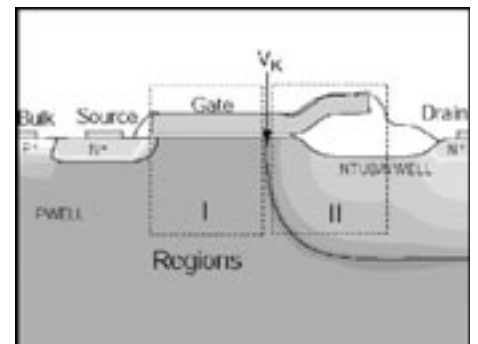

Figure 3: Rdrift modeling

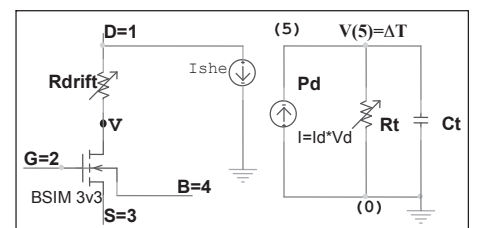

Figure 4: Modeling the self-heating effect.



Figure 5: Measurement set-up

We were also able to prove that the developed sub-circuit model predicts the transistor's behavior over an entire range of device widths, lengths and temperature.

For final verification, we chose a ring oscillator with 21 inverter stages with HVNMOS and HVP MOS sub-circuit models (see Fig.7). The ring oscillator is particularly well suited for this task because it exercises the model under DC, AC and transient conditions. It is worth noting that there were no errors or problems with model convergence.

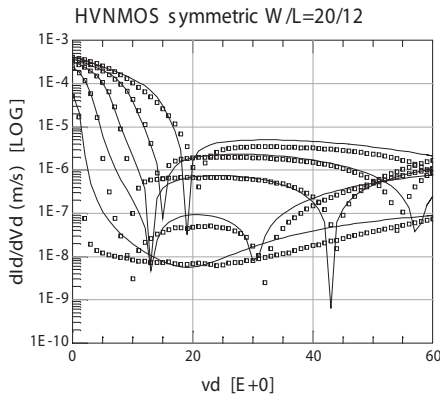
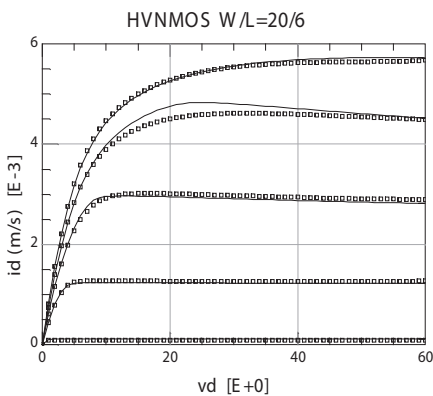

Figure 6: Results of simulation with Rdrift and SHE modeling.

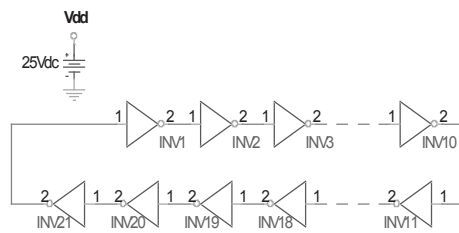
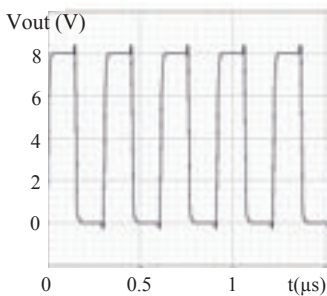

Figure 7: Ring oscillator simulation using SPECTRE

## CONCLUSIONS

In this paper, we showed that successful modeling of the HV NMOS transistors is possible with an extended BSIM3 model. All known HV problems, such as quasi-saturation and self-heating, could be resolved using the presented sub-circuit extension. Our approach is simple in implementation, inexpensive and can be used in a range of commercial models.

## REFERENCES

- [1] J.Pieczynski, I.Doncov, "Modeling of High-Voltage NMOS Transistors using Extended BSIM3 Model", MIXDES 2008, pp.75-80, Poznan, Poland, Juni 2008.
- [2] E.Seebacher, "HV MOS Modeling", MOS-AK, Böblingen, 2006, Germany.
- [3] E.Gondro, P.Klein and F.Schuler, "An Analytical Source-And-Drain Series Resistance Model of Quarter Micron Mosfets and its Influence on Circuit Simulation", p.VI206-VI2009, IEEE 1999.
- [4] C. Anghel, "High Voltage Devices for Standard MOS Technologies – Characterisation and Modeling", These No 3116 (2004), EPFL, Lausanne, 2004.

## I Introduction

*Charge-coupled devices* (CCD) have been the dominant technology in the field of solid-state imaging for a couple of decades due to their capability to perform very efficiently and uniformly over large areas, the collection and transfer of photogenerated charge carriers and their measurement at low noise [1]. But today, the maturity of *complementary metal-oxide-semiconductor* (CMOS) technology based photodetectors is established, and the advantages of their specific features which allow *x-y* pixel addressing, in-pixel amplification and signal processing, the “camera-on-a-chip” [2] approach, and the use of deep sub-micron standard CMOS processes make them a perfect candidate for an increasing number of imaging applications. The frontiers are to be pushed further in what signal and spatial resolutions present in CMOS imagers are concerned, considering their application in automotive or medicine oriented industries, basic science, or telecommunications. In this sense, the need for constant optimization of photodetectors and entire imager systems has become for the *CMOS Imaging* group at the *Fraunhofer IMS* evident with time.

In the year 2008, the industry available standard CMOS process minimum feature dimensions are to be found between the 120 nm and 65 nm. The latter, driven by the desire of smaller device area, lower power consumption, higher operation speed, and increased functionality. Nevertheless, as expressed by Wong [3] back in 1996, while “standard” CMOS technologies were providing adequate imaging performance at the 2  $\mu\text{m}$ –0.8  $\mu\text{m}$  generations without any process changes, some modifications to the fabrication process and innovations of the pixel architecture are

needed to enable CMOS processes for good quality imaging at the 0.5  $\mu\text{m}$  technology generation and below. Regarding the pixel size, Wong [3] suggested that CMOS imagers would benefit from further scaling after the 0.25  $\mu\text{m}$  generation only in terms of increased fill-factor and/or increased signal processing functionality within a pixel. The latter proved true, and an increased number of imager manufacturers are introducing special imaging enhanced CMOS processes, departing from “standard” CMOS logic and memory processes at the 0.35  $\mu\text{m}$ –0.25  $\mu\text{m}$  and below technology generations. In this context, the 0.35  $\mu\text{m}$  standard CMOS process available at the Fraunhofer IMS for fabrication of imager systems will be investigated in this paper to understand its real imaging performance capabilities. Following, different additional process steps developed and other improvements undertaken so far will be described, as well as a couple of examples of current research lines followed for its further optimization.

## II Phototransduction

High doping profiles, thin gate-oxides and low bias voltages affect adversely the performance of CMOS imagers, and can still cause problems if standard solutions to some of the issues affecting the photodetector pixel performances are to be applied. This includes using separated photoactive and read-out node areas (e.g., floating  $n^+$  diffusions (FD) separated from photodiodes or photogates), where charge-coupling between the two regions [4] is not always possible. On the other hand, the reduced SCR widths (of around 0.16  $\mu\text{m}$  to 0.55  $\mu\text{m}$ ) degrade the photodetector quantum efficiencies, especially in the NIR part of the spectra.

The standard 0.35  $\mu\text{m}$   $n$ -well double polysilicon and 4 metal layers CMOS process available at the Fraunhofer IMS for fabrication of CMOS imagers combines *low-voltage* (LV) and *high-voltage* (HV, up to 80V) MOSFETs. It features a thin LV and a thicker HV gate-oxides, two polysilicon layers with two different work-functions ( $n^+$  doped polysilicon in case of NMOS transistor gates, or  $p^+$  doped one in case of PMOS transistor gates), a second polysilicon layer, as well as five available substrate concentrations.

Figure 1, on the other hand, shows the results of the two dimensional simulation of the 0.35  $\mu\text{m}$  CMOS process mentioned, where both the HV and the LV MOSFET pairs ( $p$ -type and  $n$ -type MOSFETs) [5] can be observed. The process offers the possibility of fabricating eight different reverse-biased  $p$ - $n$  junction based photodetectors: 1) HV  $n$ -well photodiode (PD); 2) LV  $n$ -well PD; 3) LV BPD, which features a  $p^+$  (source/drain) diffusion on top of the LV  $n$ -well, used to push the electrostatic potential maximum from the silicon surface and thus improve the dark current and detector noise characteristics; 4)  $n^+$  (source/drain implantation) PD on HV  $p$ -well,  $X_j = 0.3 \mu\text{m}$ ; 5)  $n^+$  PD on LV  $p$ -well; 6)

$n^+$  PD on the  $p$ -type epitaxial layer, also understood as a quasi P-I-W Photodiode; 7)  $p^+$  PD on HV  $n$ -well; and 8)  $p^+$  PD on LV  $n$ -well.

Additionally to the reverse-biased  $p$ - $n$  junction based photodetectors presented so far, the different *metal-oxide-semiconductor capacitor* (MOS-C or *photogate* (PG)) based photodetectors which can be fabricated in the 0.35  $\mu\text{m}$  CMOS process under investigation are: 1) LV  $p$ -type PG, consisting of a LV gate-oxide grown thermally on top of a LV  $n$ -well and covered by a first polysilicon layer (POLY1); 2) LV  $n$ -type PG located on top of the LV  $p$ -well diffusion; 3) LV  $n$ -type Poly2 PG, consisting of a second polysilicon layer deposited on top of an oxide-nitride-oxide (ONO) dielectric; one of the advantages of this structure is the possibility of overlapping the first polysilicon layer, which in case of a PG active pixel configuration improves drastically the *charge-transfer efficiency* (CTE); 4) Epi  $n$ -type PG, identical to the LV  $n$ -type PG, only fabricated on top of the lower-doped  $p$ -Epi substrate; 5) Epi  $n$ -type Poly2 PG, identical to the LV  $n$ -type Poly2 PG only fabricated on top of the  $p$ -Epi substrate; 6) HV  $n$ -type PG, consisting of a HV gate-oxide thermally grown on top of a HV  $p$ -well, covered by a polysilicon (POLY1) gate; and, finally 7) a HV  $n$ -type Poly2 PG, fabricated by depositing a second polysilicon layer on top of a HV ONO structure, using a HV  $p$ -well diffusion as silicon substrate.

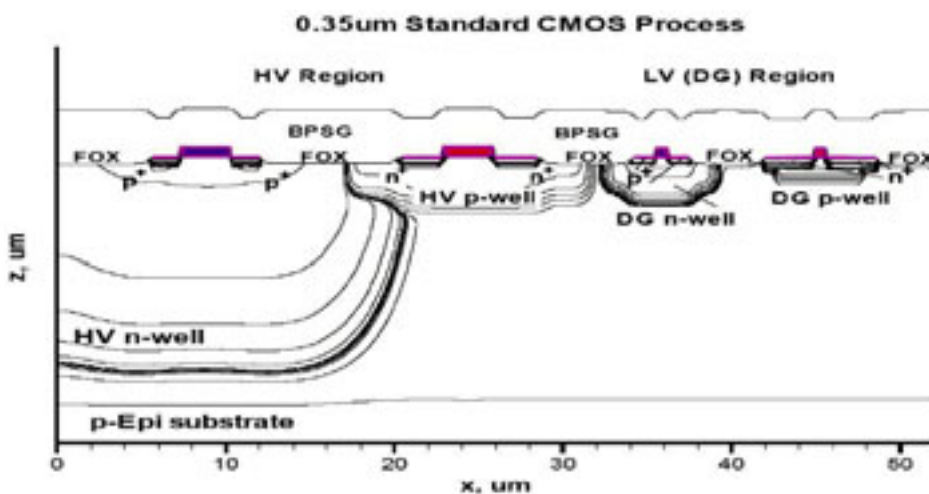

Figure 1: Two-dimensional simulation performed for the HV and LV region MOSFET pairs, fabricated in the 0.35  $\mu\text{m}$  CMOS process available at the Fraunhofer IMS [4].

### III Characterization of Different Photodetectors

In photodiode based CMOS imager pixels, there is a strong relation between the area and the perimeter of the detector, respectively, and its junction capacitance. Capacitor structures appear formed by the three dimensional

SCR of the  $p$ - $n$  junction in all directions. Following this concept, capacitance-voltage measurements are performed on identical photodetector structures with different area and perimeter values. Finally, the specific capacitance density values dependent on the photodetector area ( $C_{A'}$ , measured in  $F/cm^2$ ) and the photodetector perimeter ( $C_{P'}$ , measured in  $F/cm$ ), respectively, can be calculated for each of the photodetector structures at different biasing voltages. The specific capacitances are obtained solving the set of equations that arise when Eq. (1) is applied to a certain number of identical photodetector structures with different areas and perimeters, where  $C_{TOTAL}$  is the measured photodetector output capacitance and  $A_{PD}$  and  $P_{PD}$  are its area and perimeter, respectively, maintaining  $C_{A'}$  and  $C_{P'}$  constant.

$$C_{TOTAL} = A_{PD} (C_{A'}) + P_{PD} (C_{P'}) \quad (1)$$

The same holds for the flux of thermally generated carriers within the photodetectors, i.e. their dark currents. The equality used in this case is Eq. (2), where  $J_{A'}$  is the area dependent dark current density measured in amperes per square centimetres ( $A/cm^2$ ), and  $J_{P'}$  is the perimeter dependent dark current density measured in amperes per centimetre ( $A/cm$ ).

$$I_{dark} = A_{PD} (J_{A'}) + P_{PD} (J_{P'}) \quad (2)$$

The characteristic capacitance and dark current curves obtained from measurement performed on different test structures, that describe the photodetectors mentioned above, can be observed in Figure 2 [5].

One of the most important figures of merit related to the characterization of photodetector devices is its *optical sensitivity*, which gives the amount of photocurrent generated by a given radiant flux  $\phi$ , i.e. how many *amperes* (A) of

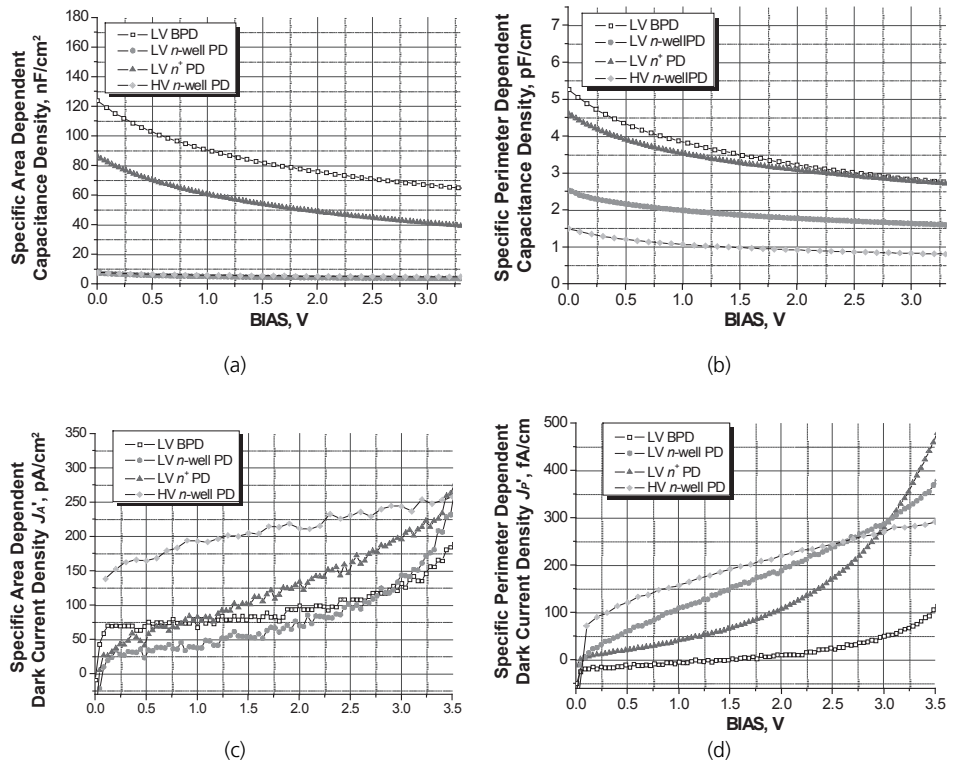

Figure 2: (a) Specific area dependent capacitance density, in  $nF/cm^2$ , for photodiode structures fabricated in the  $0.35 \mu m$  CMOS process available at the Fraunhofer IMS; (b) Specific perimeter dependent capacitance density, in  $pF/cm$ , for (a); (c) specific area dependent dark current density, in  $pA/cm^2$  for (a); (d) Specific perimeter dependent dark current density, in  $fA/cm$ , for (c) [4].

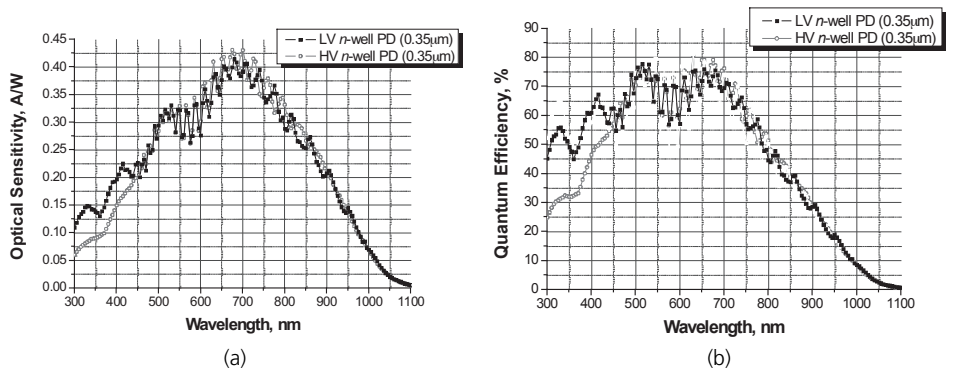

Figure 3: (a) Optical sensitivity curves (average) obtained from LV  $n$ -well PD and HV  $n$ -well PD photodetector structures fabricated in the  $0.35 \mu m$  CMOS process available at the Fraunhofer IMS; (b) quantum efficiency average curves obtained for (a) [4].

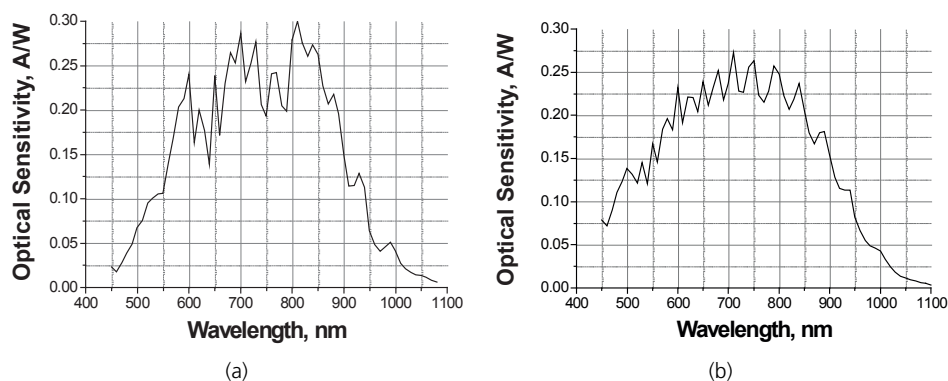

Figure 4: (a) Optical sensitivity curve obtained for the LV n-type PG photodetectors when reverse-biased at  $V_{DD} = 3.3$  V, at room temperature, fabricated with the standard used silicon-nitride based passivation layer in the  $0.35 \mu\text{m}$  CMOS process available at the Fraunhofer IMS; (b) optical sensitivity curve obtained from the same photodetector structures fabricated using the UV-enhanced silicon-nitride based passivation.

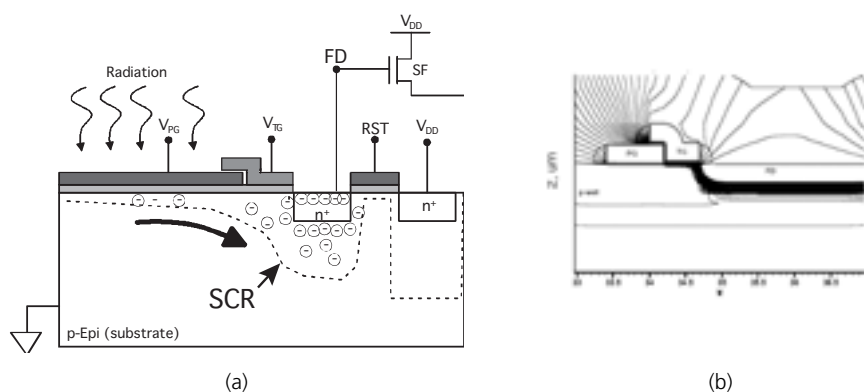

Figure 5: (a) Schematic of a photogate (PG) active pixel configuration consisting of a POLY1 layer based photogate (PG), overlapping POLY2 based transfer-gate (TG),  $n^+$  floating diffusion (FD) which at the same time is the source of the NMOS reset transistor (RST), which, together with a source-follower (SF) NMOS and a pixel-select switch transistor, represent the three transistors of this pixel configuration; (b) 2-D electrostatic potential simulation result obtained for (a).

photocurrent are generated by a single impinging watt (W) of irradiation, in A/W. On the other hand, the *spectral responsivity* provides the response of the entire pixel, measured in  $\text{V}/\mu\text{J}/\text{cm}^2$  for a certain charge-collection (photo-current integration) time. Finally, the *quantum efficiency* of a photodetector essentially indicates how many electron-hole pairs (*ehp*) are generated for each photon impinging on the detector, or the probability of a single photon to produce one *ehp*. Figure 3 (a) [5] shows the wavelength dependent optical sensitivity of the photodiode based structures fabricated in the  $0.35 \mu\text{m}$  CMOS process at the Fraunhofer IMS, for wavelengths ranging from 300 nm to 1100 nm. Figure 3 (b), on the other hand shows the quantum efficiency curves measured for the same photodetectors [5].

For the ultra-violet (UV) enhanced spectrometry, for example, a special silicon-nitride based passivation layer was developed, which at the same time can be used as an anti-reflective coating. The difference between the standard used passivation layer and the UV-enhanced one can be observed in Figure 4. Here, the optical sensitivity curves can be observed, obtained from two identical LV n-type PG photodetectors fabricated both, with the standard used passivation layer (Figure 4 (a)) and the UV-enhanced one (Figure 4 (b)), and reverse biased at  $V_{DD} = 3.3$  V.

## IV Pixel Configurations

All of the already described photodetectors can be efficiently incorporated into different types of active pixel configurations in this process. Nevertheless, an efficient design of a surface-channel PG pixel is a little bit more complicated. Figure 5 (a) shows a schematic representation of such a

pixel, while the Figure 5 (b) shows a two-dimensional electrostatic potential simulation result for the readout phase for the POLY1 based photogate (PG), 0.8  $\mu\text{m}$  long overlapping POLY2 based transfer gate (TG), and the 2  $\mu\text{m}$  long  $n^+$  floating diffusion structures, forming the core of the pixel depicted in Figure 5 (a). The measured external optical sensitivity and external quantum efficiency curves obtained from such a pixel, fabricated at the Fraunhofer IMS, are shown in Figure 6.

Fraunhofer IMS offers a unique possibility to its partners to jointly develop special process modifications (additional implantation steps, special masks, etc.) which do not change the performance characteristics of all other electronic devices fabricated in the 0.35  $\mu\text{m}$  CMOS process available. This kind of cooperation with different partners proved very successful, and currently pixel configurations are being developed including deep  $n^+$  implantations which can be used as internal gates in certain pixel configurations, salicide blocking on both polysilicon layers available, additional shallow  $n$ -well implantations (specially interesting for novel *pinned* photodiode or *buried* PG pixels), and also colour filter implementations, based on red-green-blue (RGB) Bayer pattern or stripe distributions, for example, which can be used with minimum pixel sizes of  $(3 \times 3) \mu\text{m}^2$  and achieve high temperature stability. An optical microscope photograph of our stripe-shaped colour filters and their transmittance curves can be observed in Figure 7.

## V Conclusions

Currently, the CMOS imagers are meeting the performance characteristics achieved by the mature CCD technology through careful design of the photo-

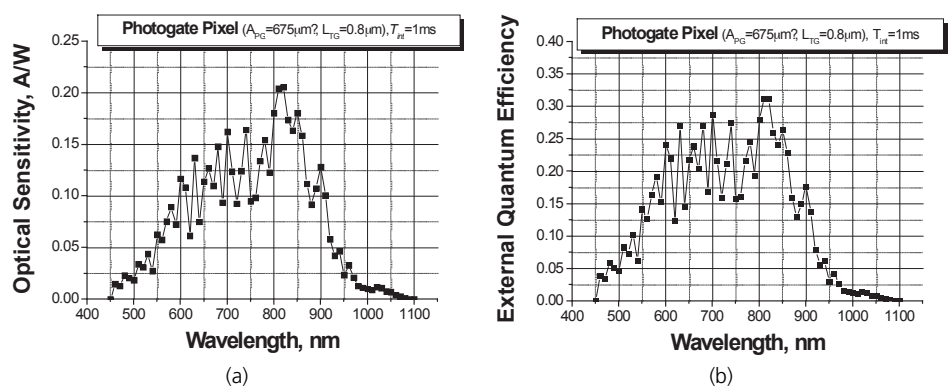

Figure 6: (a) External optical sensitivity curve, obtained from a PG active pixel configuration shown in Figure 5 (a); (b) external quantum efficiency curve obtained for (a).

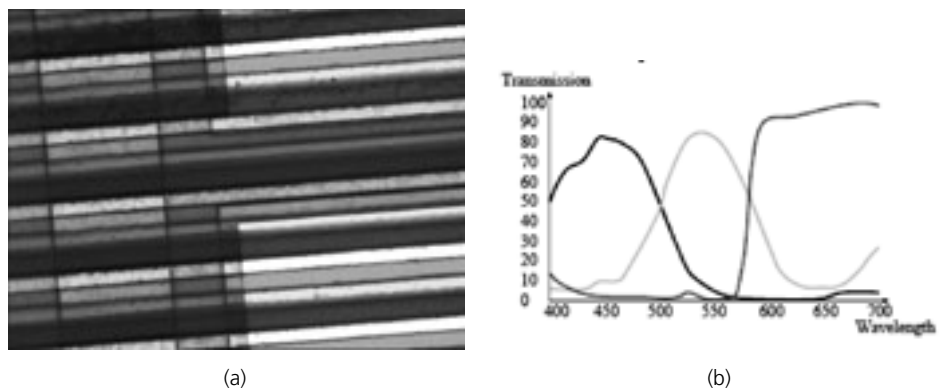

Figure 7: (a) Photograph of a stripe-shaped color filter pattern fabricated at the Fraunhofer IMS; (b) transmission curves obtained for the color filters shown in (a).

detectors, the pixels, and the entire imager systems on-a-chip, regarding all the latter elements as a whole. This enables an efficient design of the imager based on novel readout principles, and the fabrication of appropriate readout circuits thought to meet the specific characteristics of each particular photodetector and its readout mechanism. On the other side, it has become clear that standard CMOS processes, designed to meet the requirements of higher speed and reduced space through transistor miniaturization, depart from the requirements of an ideal CMOS imager. Thus, the only solution is to incorporate additional fabrication steps in order to maximize the imaging performance of a CMOS process. This is never an easy task, especially if the electro-thermo-mechanical characteristics of all the standard fabricated electronic devices existent in the process must remain. Nevertheless, sometimes small changes in the CMOS process which maintain the over-all thermal budget, and an accurate and creative design make together a huge difference. Currently, this is one of the research lines followed by the Fraunhofer IMS in the field of CMOS imaging.

## References

- [1] A. J. P. Theuwissen, *Solid-State Imaging with Charge-Coupled-Devices*, Kluwer Academic Publishers, 1996
- [2] E. Fossum, "CMOS Image Sensors: Electronic Camera-On-A-Chip", *IEEE Trans. On Electron. Dev.*, Vol. 44, Oct. 1997, p. 1689.
- [3] H. S. Wong, "Technology and Device Scaling Considerations for CMOS Imagers", *IEEE Trans. Electron. Devices*, Vol. 43, No. 12, Dec. 1996, pp. 2131-2142.
- [4] J. Janesick, "Charge coupled CMOS and hybrid detector arrays", *SPIE, Focal Plane Arrays for Space Telescope*, paper No. 5167-1, San Diego, Aug. 2003
- [5] D. Durini, "Photodetector Devices in Standard CMOS Imaging", *Proc. 4<sup>th</sup> Fraunhofer IMS Workshop "CMOS Imaging. Catching the Photons"*, 6<sup>th</sup> and 7<sup>th</sup> of May 2008, Duisburg, Germany

# Intravascular monitoring system for hypertension

P. Fürst, M. Görtz, H.-K. Trieu

## Background

Caused by the higher average age approximately 10–30 % of the population in industrial nations come down with hypertension (high blood pressure). About 10 % of this group need long term monitoring. For these patients there exist at the moment two systems:

- Catheter based measurement systems for short term blood pressure measurements in a clinical evaluation
- Extra corporal measurement systems for short or long term blood pressure measurements like blood pressure cuffs. These systems are inconvenient in handling and disturb the patients in daily life. A second disadvantage is that they do not allow continuous measurements

The presented system is aimed to overcome these limitations by providing up to 36 measurements per second of blood pressure with a fully telemetrically controlled implant that works without battery. Additional, highly precise information is gained on the transient heart rhythm and possible anomalies like syncopes.

## Components of the measuring system

The measuring system which is shown in fig. 1 consists of two main parts. The first one is the pressure sensor which is inserted into the medical catheter and is designed as small as possible to avoid clotting and minimize the flow resistance. The catheter is placed in the artery femoralis (fig. 2) The second main part is the transponder unit implanted just underneath the skin in order to guarantee optimal transmission parameters due to the transition through a minimum of skin layers.

### 1. The pressure sensor chip

The first part of the system is a narrow sized CMOS chip (fig. 3) with a micro mechanic pressure sensor fabricated along with the integrated signal conditioning circuitry. The pressure dependent capacitance of the sensor is converted into a voltage by a C/U converter. A second sensor on this chip allows a temperature measurement. The sensor is integrated at the tip of a medical catheter and is connected via a miniaturized cable to a telemetric unit.

### 2. The transponder chip

The passive transponder chip receives energy by inductive coupling from an external reader station and controls and supplies the sensor chip. The analog pressure and temperature data from the sensor chip are converted by a 13 bit cyclic RSD ADC in digital values. Data transfer from the implant to the reader station is realized by amplitude modulation of the supplied energy carrier wave.



Figure 1: System with transponder unit, micro cable and catheter

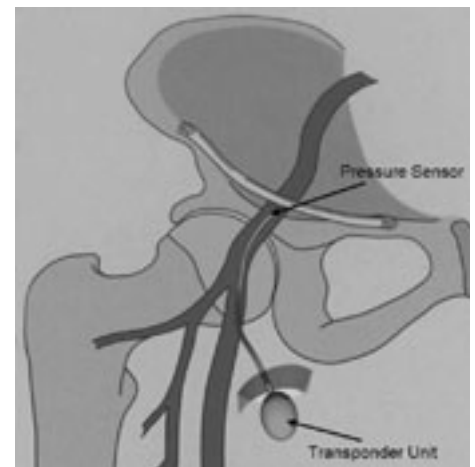

Figure 2: Measuring system

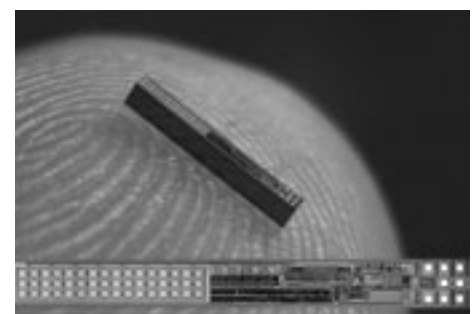

Figure 3: Unthinned pressure sensor chip

## Calibration and sensor performance

### 1. Calibration

The calibration of the non linear and temperature dependent output of the pressure sensor is performed in a temperature controlled pressure chamber. A typical calibration error better than 0.5 mbar is shown in fig. 4.

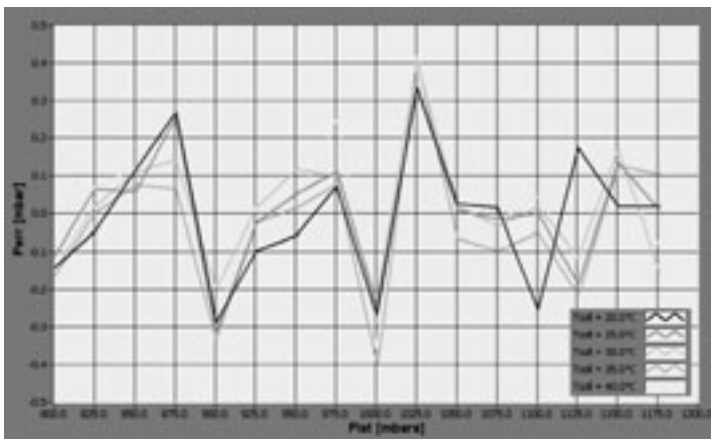

Figure 4: Calibration error example

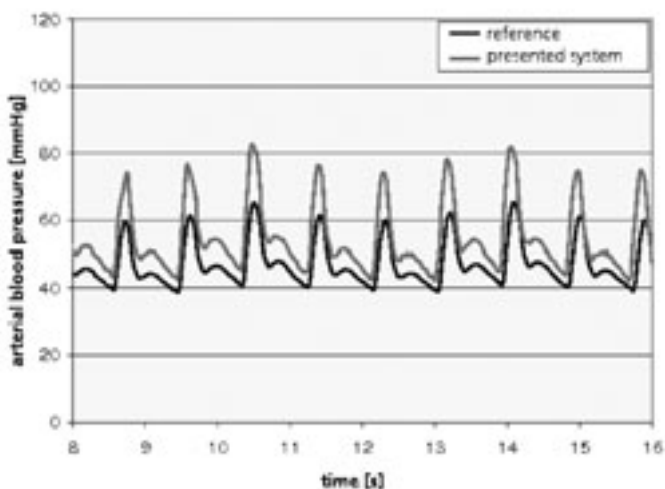

Figure 5: In-vivo blood pressure measuring results

### 2. Sensor performance

At a signal rate of 36 Hz the accuracy of the pressure sensor in a measurement range of 850 mbar to 1150 mbar is  $\pm 2$  mbar. The signal rate of the temperature sensor is 18 Hz. The temperature sensor has an accuracy of  $\pm 0.25$  K in the temperature range from 20–40°C. The power consumption during a measurement is 200  $\mu$ W.

### In vivo measurements

First experiments with an implant have been successfully completed. The implant was placed in the artery femoralis of a sheep.

The wirelessly recorded data of the implant match perfectly to the reference data of the Mammendorfer Sensor (fig. 5). The different amplitudes of the implant signal and the reference signal are caused by encapsulation effects of the preliminarily encapsulated implant.

### Acknowledgements

The presented work were achieved in the course of the project HYPER-IMS, which is granted by the BMBF.

# Nanopotentiostat for portable electrochemical measurements

Thomas van den Boom, Peter Fürst

## Motivation

The demand for chemical and biological sensors is constantly growing. Applications for medical and environmental purposes are firmly in focus. The total market for chemosensors in liquids and gases has increased from 3.8 billion \$ in 1998 to 5.4 billion \$ in 2008 [1]. The cheap, quick and effective analysis with compact and portable analytic systems is a field with future prospects. Assuming the electrochemical biosensor as a part of biosensors in general – see definition in [2] – table 1 illustrates the potential of such sensors in modern markets like “Home Diagnostic” or “Point-of-Care”, which have, in origin, medical background but become more and more lifescience accessory.

The dimensions of the required sensor elements for portable devices are continuously reduced, whereas the demands for the transducer grow. Additionally, a high cost pressure arise for chemosensors and biosensors due to relatively short service life. That cost pressure is the reason, that not the accuracy of measurement is in the foreground but the price of the sensor, fabricated in high quantities. Besides, strategic reasons do play an important role for the development and fabrication of biochemical sensors with methods of silicon-based technology. Here, the possibility to monolithically co-integrate sensor and sensor-signal-processing components promises the development of new sensor systems with high complexity and precision.

For such an integration sensors come into consideration, where the biochemical information of the substrate is transformed into an electrical signal. This is the case for electrochemical sensors. Most of the commercialised biosensors are based on amperometric measurement principles. The substance to be detected will be transformed

directly at inert electrodes and thus a current generated, which is in well-known relation to the concentration of the analyte. Mainly amperometric enzyme-electrodes are both regarding described sensors in literature as commercially offered biochemical sensors at the top [3].

Common amperometric measurement methods are based on techniques that use either two or three sensor electrodes. The two-electrode measurement technique is easy to handle and simplifies the measurement equipment, but the sensor signal is distorted by the resistance of the analyte solution (Fig. 1).

	Home Diagnostic	Point-of-Care	Environmental	Security and Biodefense
2003	777.1	1803.0	472.4	86.9
2007	1069.0	2679.3	688.6	135.8
2009	1298.1	3247.7	860.8	174.6
2011	1627.1	3975.4	1098.0	231.0
2013	2085.5	4897.1	1427.1	313.5
CAGR	11.4%	10.5%	12.6%	14.6%

Table 1: Total Biosensors market: Revenue forecasts by vertical markets (world), 2003 – 2013 [2]

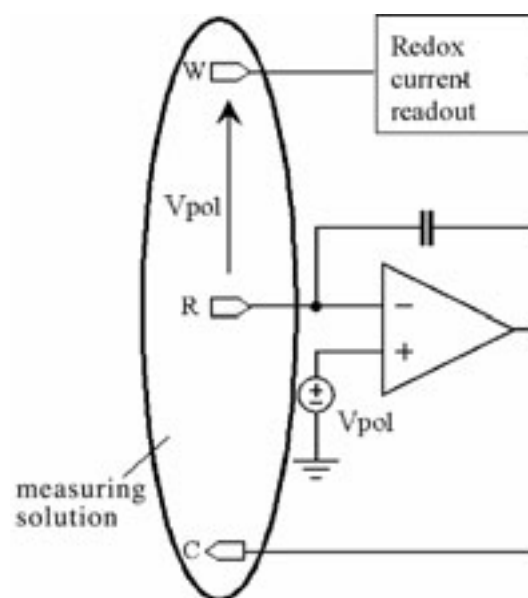

Figure 1: Principle of a three electrodes potentiostat

To prevent the effect of the voltage loss in the solution, that is caused by the redox current, a third electrode is located nearby the working electrode. Because of its high electrode impedance there is approximately no current flow through this reference electrode. The counter electrode is controlled in a way that the voltage of the reference electrode is similar to the polarization voltage. Because of the small distance to the grounded working electrode the voltage loss is reduced to a minimum.

The use of integrated microelectrodes results in very small currents in the range of nanoamperes that are very sensitive to any noise components. To optimise the performance of the system, a signal processing is needed close by the sensor electrodes.

Typical lab-size potentiostat devices are not suitable for portable electrochemical measurements since they have large outer dimensions and are too expensive for such applications. Commercially available devices today cost typically 10.000 Euro (e.g. Ametek, Gamry, eDAC, ACM, Jaissle) and more. But developments in the "modern" applications like home diagnostic or point-of-care with the tendency to mass market or even security and biodefense (see Table 1) require on the one hand

very small devices, on the other hand very cheap ones.

One application example, shown in Fig. 2, for home diagnostics / lifescience is the measurement of lactate in blood. In the first development step, enzymes will be immobilised in a gel matrix.

The immobilized enzyme lactate oxidase on one electrode transforms selectively lactate into pyruvate and hydrogen peroxide (H<sub>2</sub>O<sub>2</sub>).

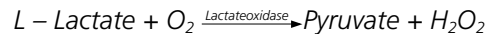

The released hydrogen peroxide (H<sub>2</sub>O<sub>2</sub>) oxidates on one platinum electrode and generates a current proportional to the lactate concentration of the solution.

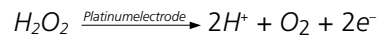

### The IMS nanopotentiostat

For the measurement of the electrochemical current a counter electrode is needed, which dives into the same measuring solution as the working electrode (the one covered with the enzyme lactate oxidase). Through application of a constant voltage between both electrodes, the redox current at the working electrode can be measured sensitively. An additional reference electrode produces a defined voltage to the electrolyte and enables to control the potential drop at the working electrode.

Size and costs are the motivation to build up a single-chip nanopotentiostat for electrochemical measurements. The IMS nanopotentiostat is designed to be used as a stand-alone chip. It will be mounted on a small PCB. Electrodes can be plugged on easily with a standard connector. It has a completely integrated (two-phase) clock generator,

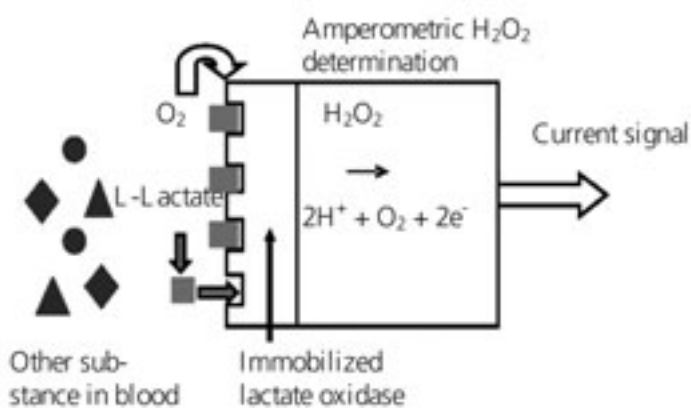

Figure 2: Measurement of lactate in blood

a completely integrated current bias and a selectable analog or digital output of the redox current. For the digital output, a second-order one-bit sigma-delta-modulator has been implemented.

The functionality of the nanopotentiostat can be divided into two parts:

- 1) The control part measures the potential of the reference electrode and controls the counter electrode in a way that the reference electrode has the polarization voltage. The main part of the electrode control is a three stage operational amplifier which works with a capacitive feed back.

- 2) The redox current at the working electrode is converted by a SC-integrator into an internal voltage. When the nanopotentiostat is in analog modus this voltage is amplified by the S&H amplification part. In case of the digital modus is selected, the result of the current voltage conversion is converted by a second-order one-bit sigma-delta-modulator.

The current range of the nanopotentiostat is by variation of the SC integrator capacitor adjustable. By using the internal clock frequency of 2.5 KHz the minimum redox current range is  $-1.5 \text{ nA}$  to  $+1.5 \text{ nA}$ , the maximum current range is  $-250 \text{ nA}$  to  $+250 \text{ nA}$ , respectively. The integrator capacitor is thereby adjustable in 255 steps. Another way to control the current range is the usage of an external clock. The maximum current range can be increased up to  $20 \text{ }\mu\text{A}$  with an external clock frequency of 200 KHz. The accuracy of the redox current is 10.5 bit. This results in an accuracy of  $1 \text{ pA}$  in the current range from  $-1.5 \text{ nA}$  to  $+1.5 \text{ nA}$ .

The nanopotentiostat is small enough to be co-integrated with the micro- or nanoelectrodes monolithically on one chip for all applications, where the system is used as disposable because of

dimensions or environment conditions. Or it can be used for a two-chip system, where the electrodes are integrated on a passive sensor chip and the nanopotentiostat is realized on a second chip. The nanopotentiostat can than be mounted in a plug where it is shielded from the measurement environments like liquids. The modular system allows the electrodes to be exchanged after their operating life. Due to CMOS fabrication, chip size and costs are kept to a minimum. The layout of the IMS nanopotentiostat is presented in Fig. 4.

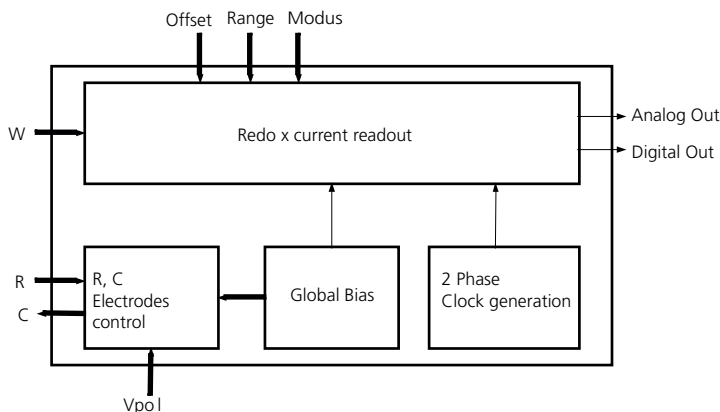

Figure 3: Blockdiagramm of the IMS nanopotentiostat

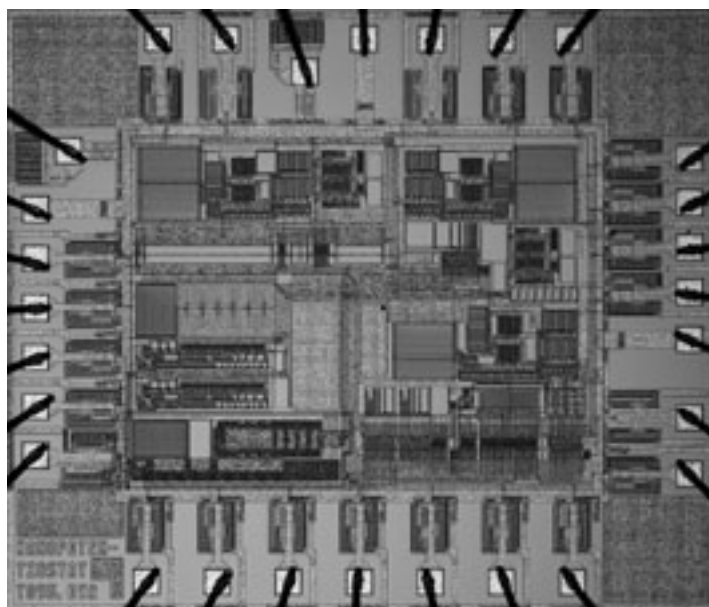

Figure 4: Chip foto of the IMS nanopotentiostat

Figure 4 depicts the layout of the nanopotentiostat. The technology chosen is a 0.8  $\mu\text{m}$  standard CMOS technology. The chip size is 2.51 mm x 2.13 mm. The main building blocks are on top right the SC-integrator for the redox current readout, on top left the S&H amplifier driving the integrators output, on bottom right the sigma-delta-modulator and on bottom left bias and clock generation blocks. The chip has 28 connections.

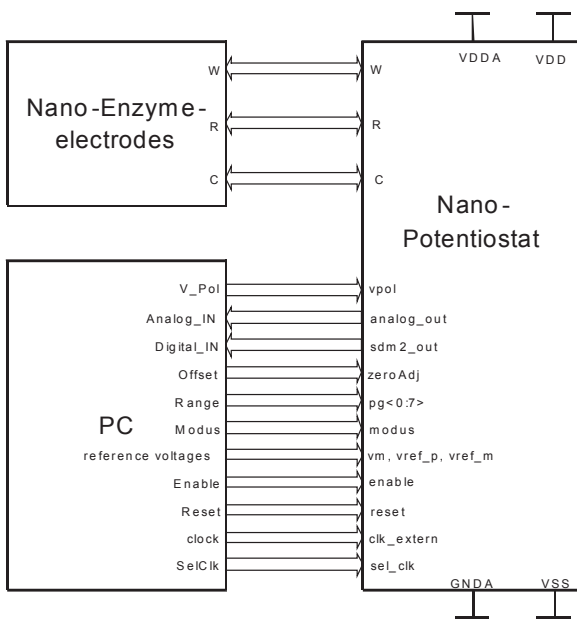

Figure 5: Controlling the IMS nanopotentiostat by PC or  $\mu\text{C}$

Parameter	Specification	Condition
Redox current ranges in analog modus	1.5 nA–250 nA	clk = 2.5 KHz
Redox current ranges in digital modus	15 nA–2500 nA	clk = 1 MHz
Max. redox current in analog modus	20 $\mu\text{A}$	clk = 200 KHz
Max. redox current accuracy	1 pA	clk = 2.5 KHz
Max. applied potential	2.5 V $\pm$ 2 V	
Typical supply voltage	5 V	

Table 2: Main Specification of the nanopotentiostat

## Specifications

The control and readout of the nanopotentiostat can be easily performed by a  $\mu\text{C}$  or a PC (Fig. 5). LabView (version 8.2) modules for the control of the nanopotentiostat and the measurement cycles are under construction.

The main specifications of the IMS nanopotentiostat are given below in table 2.

## References

- [1] Schneider Electric Expands In Sensing Technology; Paris, March 25, 2004, (data from Intechno Study 2004)
- [2] World Biosensor Markets, Frost & Sullivan, Okt. 2007, N211 – 32
- [3] Köster, Oliver; Ein Beitrag zur elektrochemischen Sensorik: Entwicklung und Charakterisierung von planaren amperometrischen Mikroelektroden unter Einsatz statischer und dynamischer Testverfahren; Dissertation, Universität Duisburg, 2000

## Introduction

In more than fifteen years of research and development in high-temperature CMOS SOI technology, the Institute of Microelectronic Circuits and Systems (IMS) has realized many circuits for temperatures of up to 250°C and beyond. IMS made several pioneering contributions to this field, like tungsten metallization and high-temperature EEPROM devices.

With the "Hochtemperaturelektronik" project, funded by the state of North Rhine-Westphalia until 2006, a new chapter of our high temperature electronics history was started with the transfer of our know how to the new 200mm production facility of IMS, and the establishment of an infrastructure that enables the design and production of commercial-grade high temperature CMOS (HTCMOS) integrated circuits. This work has been continued and expanded, and some of the results are detailed in the following pages.

## High Temperature Pressure Sensors

Micromachined pressure sensors have been pursued for a long time at IMS, usually integrated into a standard CMOS process on silicon bulk wafers. This process module was also integrated into the new 1  $\mu\text{m}$  high-temperature CMOS SOI process. The pressure sensor consists of a polysilicon membrane over an active area, together forming a capacitor whose capacitance depends on the deformation of the membrane by the ambient pressure. As only materials and processing steps are used that are also present in CMOS processes, the sensor can be built wholly in our standard CMOS fabrication facility.

For a high resolution of the pressure signal, very small changes in sensor capacitance, in the order of a few tens or hundreds of Attifarads ( $10^{-18}\text{F}$ ) must be resolved. In order to eliminate the influence of long bond wires connecting the pressure sensor to a conditioning circuit, the conditioning circuit must be integrated on the same die as the sensor. This, of course, can easily be done in the IMS high-temperature CMOS SOI process.

The capacitive readout circuits, the capacitance/voltage (C/V) converter and amplifiers, were realized as Switched-Capacitor (SC) circuits. The SC-circuits use discrete-time processing of analog values so that the common analog functions based on operational amplifiers and resistors can be realized by substituting switches and capacitors for the resistors. This technique is easily implemented in CMOS ICs, and is well-matched to both the sensor and high temperature operation: as the sensor already is a capacitor, it naturally integrates into an SC-circuit. The characteristics of the SC-circuits mainly depend on the capacitors used. Like the vacuum used as the sensor "dielectric", the silicon dioxide used as dielectric in the integrated capacitors has a very small dependence on temperature. The various types of resistors used in a typical CMOS technology usually have widely varying temperature coefficients, which make it difficult to design circuits which must work over a temperature range spanning up to 300K.

Nevertheless there is still a temperature dependence present in the final pressure signal. Figure 1 shows this dependence for the pressure output signal. Especially for low pressures it will incur a large error on the displayed pressure value after linearization of the signal. Therefore signal linearization must take

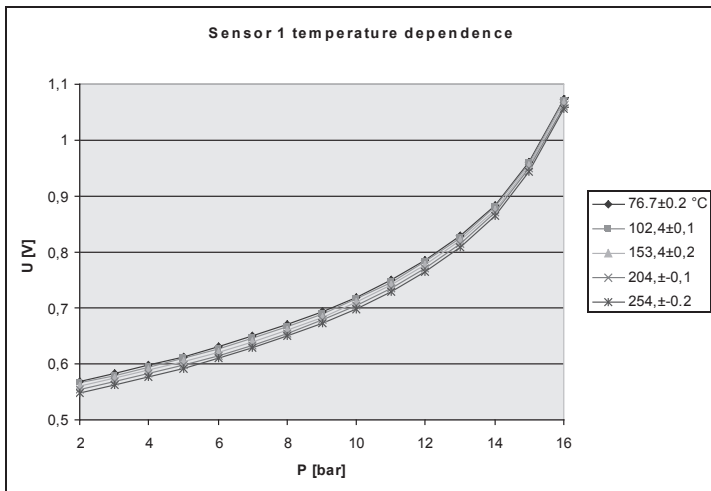

Figure 1: Pressure Sensor Test Chip: Typical Temperature Dependence

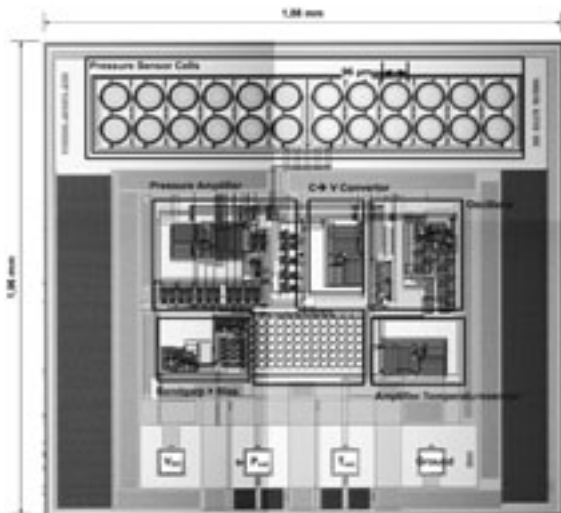

Figure 2: Pressure Sensor Test Chip

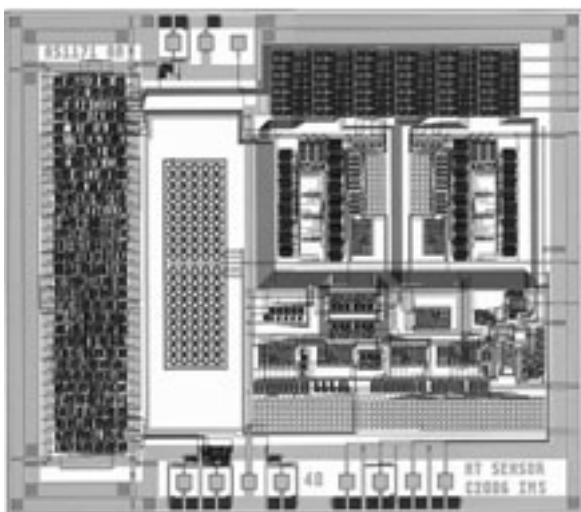

Figure 3: Advanced Pressure Sensor Chip

into account the actual operating temperature of the sensor. An additional temperature sensor and an attached amplifier are also integrated on the sensor dies to supply this information.

For the characterization of the pressure sensor we designed a test chip (Fig. 2), which was fabricated in several variants. These variants differ in the sizes of the sensor membranes: As the membranes become stiffer with decreasing diameter, the force needed to deform them increases. Thus membranes with smaller diameters will have a higher “full-scale” pressure. The chip variants therefore are targeted at different pressure ranges, with full-scale pressures from 3 bar to 70 bar.

The sensors were assembled in ceramic DIL packages and tested using a custom-built pressure chamber which can be used for temperatures between room temperature and 250°C. They were operational at all temperatures and pressures and showed the expected behavior (Fig. 1). The accuracy achievable with the test chip, after linearization and temperature correction, is 1 % to 2 % of the full scale. Samples of this chip have also been tested by industry, with very favorable results.

The resolution of the pressure sensor can be improved by using more membranes in parallel and also by performing some of the linearization on chip. An advanced pressure sensor ASIC is shown in Fig 3. Like the test chip, it was fabricated in several variants for different pressure ranges. The 13 mm<sup>2</sup> die comprises the sensor array, C/V converter, programmable linearization circuit, output amplifiers, temperature sensor and digital control logic. The expected accuracy for this design is better than 0.5% full scale after final linearization and temperature correction.

These pressure sensor chips can be used in a variety of applications. Due to their small size they can be used in small spaces where cooled “traditional” sensors cannot be used. This applies e.g. to chemical microreactor or automotive applications.

## High Temperature EEPROM

Electrically Erasable Programmable Read-Only Memories (EEPROM) are needed for many applications, e.g. as storage for data loggers, as reconfigurable program memory for microcontrollers, or to store individual information like identity or calibration data. Operating these memories at high temperatures is not straightforward as the charge of the floating gate, which encodes the stored information, decays far more rapidly at higher temperatures than at room temperature.

This limitation affects all applications in which the system lifetime is more than a few months. In these systems additional steps must be taken to prolong the data retention of the EEPROM. The serial EEPROM chip we designed provides support for implementing these measures. In systems that operate continuously or periodically, special read modes can provide an early warning of charge loss. Then the data can be recreated by re-reading it with the normal read mode, followed by programming that data. In systems that operate sporadically, the use of single-error correction and double error detection redundancy coding can be used to recreate a small amount of corrupted data. In both cases, the longest system downtime at high temperature may not exceed the data retention time of the cells themselves.

The characterization of the EEPROM devices showed full functionality from room temperature to 250°C. The cell data retention time at 250°C is more than 5000 hours, or more than half a year.

## Conclusion

The results from the characterization of the high temperature ASICs and sensors show that the devices are fully able to operate at 250°C. As we can now make available samples to interested developers, we expect that more applications for high temperature ASICs will arise. At the same time we continue the development of our processes and circuits, as well as assembly technology for high temperatures. As the accumulated experience with this technology drives down cost and improves reliability, many new applications can be expected to take advantage of high-temperature electronics.

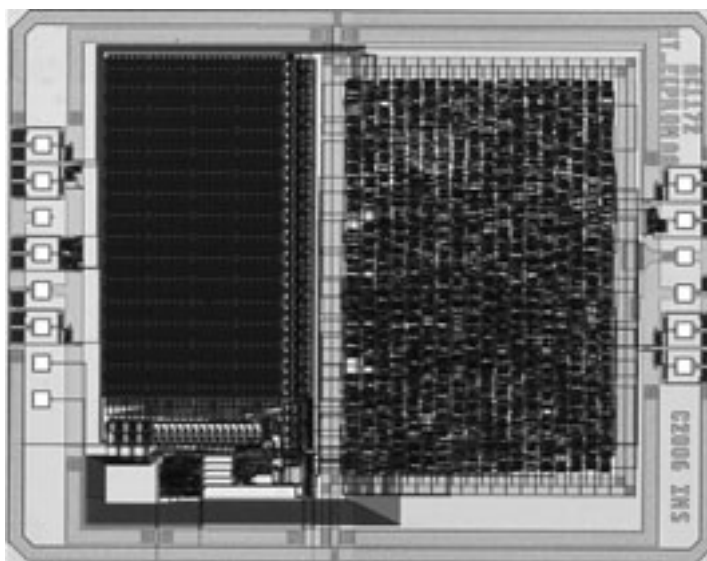

Figure 4: 128x8bit EEPROM

Research, Development and Production of customer specific analog, digital and mixed signal integrated circuits is one of the core competences of Fraunhofer IMS in Duisburg.

## Technology

Fraunhofer IMS operates a series production capable CMOS fabrication line. Besides standard CMOS processes down to 0.35µm, special processes are offered providing e.g. integrated sensors like pressure, temperature or image sensors. In addition a high temperature SOI based CMOS process is available. Based on this process, high temperature capable integrated circuits operating at temperatures up to 250° C are feasible. Besides the CMOS fabrication line, the institute operates a Microsystems technology lab. Inside this lab additional processing steps and materials beyond standard CMOS are available offering innovative capabilities for further miniaturization and integration.

## Applications

Fraunhofer IMS offers turn key ASIC solutions including supply chain services based on the in house CMOS technology. Integrated MEMS/sensors with analog and digital functions towards complex system on a chip (SoC) solutions is a goal for many customers, since it offers the possibility of minimum cost and increased reliability. A wide range of applications has been addressed by IMS ASICs. The variety of developed ASICs ranges from dedicated pure analog or digital ASIC solutions up to complex mixed signal SoC solutions, considering various constraints like low power for battery powered or even RF powered devices, on chip embedded memories or integration of sensors or actuators. Besides the standard CMOS integration, IMS offers solutions for harsh environments based on the high temperature process.

## Mixed signal ASICs

The Fraunhofer IMS CMOS technologies are perfectly suited for single-chip integration of complex digital functions (including microcontrollers) combined with high precision analog functions like e.g. A/D converters, filters and amplifiers. Low power, low voltage, and low noise design techniques are well established for mixed analog and digital application specific integrated circuits (Mixed Signal ASICs) featuring a large number of applications and requirements like high temperature electronics, transponder systems, intelligent integrated sensors and instrumentation systems. Analog and mixed signal IPs are available. A mixed top down / bottom up design flow methodology (see Fig 1) is employed for the design of the integrated circuits. This allows highly integrated and innovative solutions for

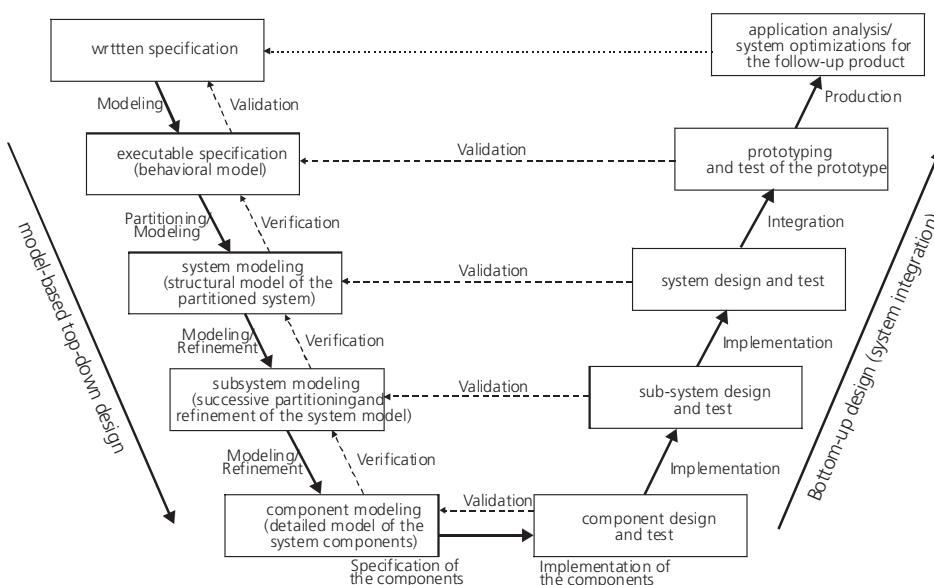

Figure 1: Mixed top down / bottom up ASIC design flow methodology

various product ideas. Fig 2 shows an example IMS SoC solution for wireless pressure sensing. Mixed signal integration offers an excellent opportunity to achieve high functional density, low power consumption, small chip sizes, as well as low system cost. Designs are based on comprehensive digital and analog libraries which can be supplemented by custom tailored components in order to meet the specific needs of individual products. The portfolio of IMS CMOS process technologies even allows to integrate special features for high voltage or power outputs and peripherals as well as non-volatile storage (EEPROM) or the realization of mixed signal high temperature devices like e.g. a 250° C capable analog to digital converter, which is shown in Fig 3.

### Embedded microcontrollers

Today's integrated systems typically include a digital processing section that is either characterised by an application specific implementation or that is based on a standard embedded microcontroller. The IMS portfolio of powerful microcontrollers features control- and computational applications embedded into an ASIC. Microcontroller cores are available as technology-independent, synthesizable HDL-models. This approach guarantees for an easy and secure adaption to almost any target technology. The portfolio consists of several controller cores, e.g. IMS2205 (8 bit, compatible to Motorola 68HC05) and IMS3311 (8 bit, compatible to Motorola 68HC11). IMS microcontrollers are complemented by a large number of standard as well as application or custom specific peripherals. The design flow includes the capability of rapid prototyping and hardware software co-design based on a powerful hardware driven emulation concept.

### Mixed signal interface and sensor front-ends

Beside typical application areas for analog front-ends e.g. the telecommunication infrastructure (e.g. DSL), IMS has developed a wide spectrum of analog front-ends for sensor read out, instrumentation, and industrial automation. Single chip System-on-Chip solutions have been realized, were analog and digital signal condition, linearization and calibration of sensors combined with a small form factor are playing a key role for innovative and integrated microsystems. IMS technologies combined with the mixed signal design skills provide embedded sensors with signal processing on very small modules or even on single chips. This has already been demonstrated in several sensing applications including patient monitoring and industrial equipment. Various IPs like e.g. filters, frequency synthesizers, and oscillators have been developed in order to allow short design cycles and thus short time-to-market.

### Expertise and performance spectrum

The IMS ASIC services offer design and production from one source. Starting from the specification or if necessary a feasibility study, the IMS ASIC services comprise development, prototyping, industrialization and fabrication of these ASICs. This empowers innovative and cost efficient ASIC solutions for small and medium volumes.

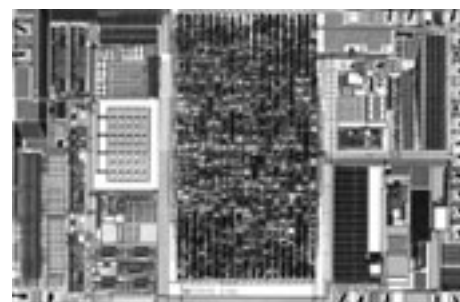

Figure 2: IMS SoC solution for wireless pressure sensing

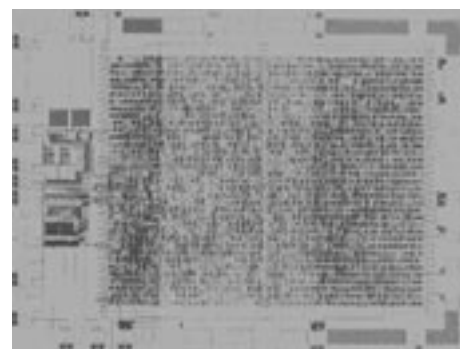

Figure 3: High temperature analog to digital converter

## Introduction

The demand for uncooled infrared focal plane arrays (IRFPA) for imaging applications is increased drastically since the beginning of the nineties. With a further price reduction of IRFPAs a growing number of new infrared imaging applications will appear. Examples for the application of IRFPAs are thermography, pedestrian detection for automotive, firefighting, and infrared spectroscopy.

IRFPAs consist of an array of microbolometers located on top of a CMOS substrate which comprehends the readout circuit. Typical array sizes are for low-cost applications 160 x 120 or 320 x 240 pixels. State-of-the-art IRPGAs achieve VGA-resolution with 640 x 480 pixels.

package is required. The microbolometer converts the infrared radiation into heat energy and this induces a temperature rise resulting in a change of the electrical resistance. Typical microbolometers have pixel pitch values of 35  $\mu\text{m}$  or 25  $\mu\text{m}$ . Fig 2 shows a microbolometer array with 4 x 4 sensor elements.

## Readout concepts

The electrical signal of a microbolometer is a radiation dependent change of the electrical resistor. The microbolometer can be readout by applying either a bias voltage or current to the resistor and measuring the resulting current or voltage. The readout circuit has to be designed under the constraints of a low-power and low-noise circuit. The performance of both microbolometer and readout circuit can be quantified by the noise equivalent temperature difference (NETD) as the minimum detectable temperature difference. Typical values for commercially available IRFPAs reach NETDs much lower than 100mK, a NETD of 80 mK – 200 mK is sufficient for many infrared imaging applications. [2]

Conventional readout circuits for IRFPAs use a column-wise architecture [3]. Pixel-wise readout technique can reduce the NETD by lowering the readout bandwidth but at the cost of higher power consumption and is limited to the available pixel area. The readout principle can be distinguished between analog and digital approach.

## Analog readout

A typical analog readout circuit applies a bias voltage pulse to the microbolometers and integrates the current flowing over a fixed period of time. Fig. 3

## Microbolometer

The IR-sensitive sensorelement based on the principle of a microbolometer. It is fabricated by post-processing on CMOS wafers in IMS Microsystem Lab. The principle of a microbolometer is shown in Fig. 1 as a cross section. A micromachined membrane consisting of amorphous silicon is suspended by two via stacks of metal from the CMOS substrate. The membrane forms with two other layers a good interferometric structure for radiation absorption. On top of the membrane a antireflection layer with a sheet resistance of 377  $\Omega/\text{sq}$  is deposited. The bottom structure consists of a nearly perfect reflecting metal layer [1]. To increase the thermal resistance the membrane is fixed by two small legs (Fig. 2). The distance between membrane and reflection metal reaches an optimum for one quarter of the radiation wavelength to be detected. To reduce thermal losses by gas conduction a vacuum

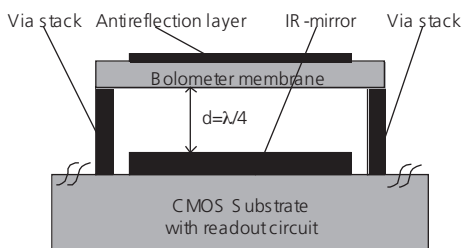

Figure 1: Principle of a microbolometer (cross section)

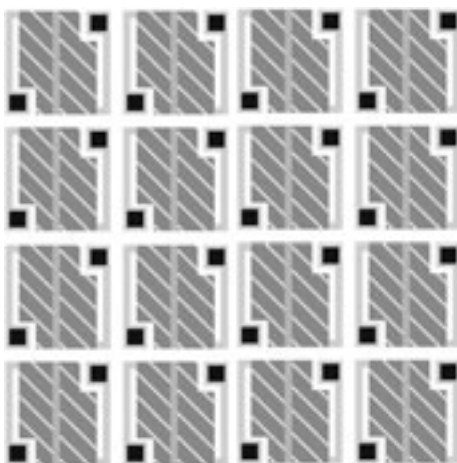

Figure 2: Principle of a microbolometer array (top view)

shows a time-continuous integrator as a readout circuit. The pixel to be readout is selected by a select transistor. The current flowing through the microbolometer resistor will be integrated using an operational transconductance amplifier (OTA) and an integrating capacitance  $C_{int}$ . A reset switch connected in parallel with the integration capacitor determines the integration time of the microbolometer current and limits the bandwidth of the readout circuit. The current of the microbolometer consists of a constant and a radiation dependent part. For the integration of only the radiation dependent part the constant part has to be subtracted. This will be done by a digital adjustable current source at the inverting input of the OTA. The voltage source  $V_{offset}$  at the non-inverting input of the OTA will define the bias voltage applied to the microbolometer. A sequencer controls the selection of the columns and rows to be readout. The output voltage of the integrators are fed to correlated-double sampling (CDS) stages. The CDS reduces the  $1/f$ -noise of the readout circuit. Finally the output is sampled and hold, multiplexed, and fed to the output buffer.

Fig. 4 depicts a chip photo of an in-house development IRFPA with 160 x 120 pixel array with a pixel pitch of 35  $\mu\text{m}$ . The chip has been fabricated in a standard 0.35  $\mu\text{m}$  CMOS process and occupies a die area of 121  $\text{mm}^2$ . The chip area is not optimized because the complete readout architecture is located besides the microbolometer array. The chip has been electrically characterized without the microbolometer post processing steps. For the calibration of the IRFPA four additional temperature sensors based on diodes are integrated.

## Digital readout

A straight-forward IRFPA with digital output can be realized by using the analog readout principle and combine it with a column-wise or serial-wise ADC instead of an analog output buffer. A more sophisticated solution is to integrate the readout principle directly into the ADC. This can be done by using the principle of a sigma-delta ( $\Sigma\Delta$ ) modulator. A  $\Sigma\Delta$  modulator achieves a high signal to noise ratio (SNR) by combining oversampling, interpolation, and noise shaping while dispensing with the need of high precision analog components. It relies on the noise spectrum of coarsely quantized input signal being

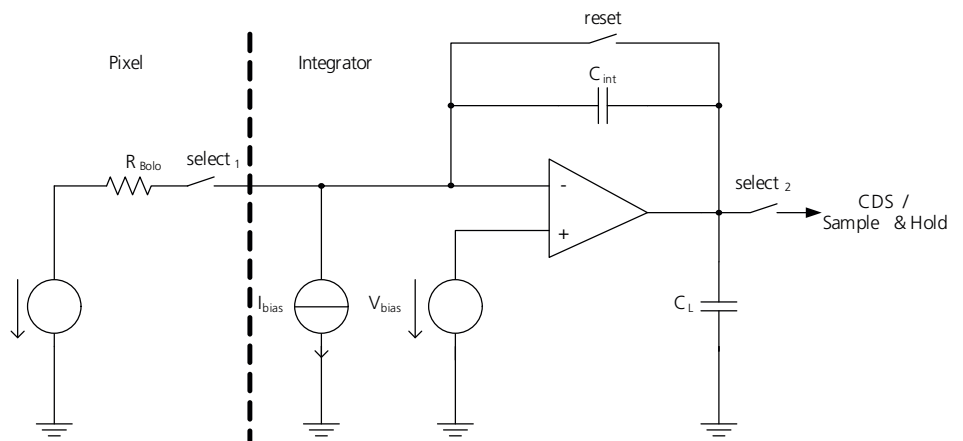

Figure 3: Analog readout principle: Integrator

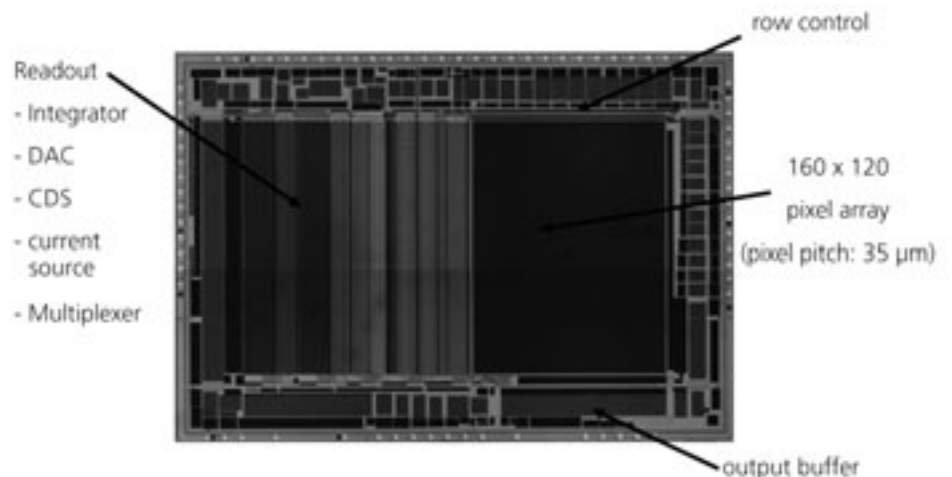

Figure 4: Chip photo of a 160 x 120 pixel IRFPA

shaped and shifted out of the signal band to higher frequencies to achieve fine quantization. The IMS developed a highly innovative IRFPA using the  $\Sigma\Delta$  principle in a public funded project called FIRKAM.

The readout of the microbolometers based on the use of a 2<sup>nd</sup> order modulator followed by a 3<sup>rd</sup> order sinc-filter with a resolution of 16 bit. The 2<sup>nd</sup> order sigma-delta modulator is realized using single-ended switched capacitor (SC)-technique (Fig. 5). For noise requirements the 1<sup>st</sup> integrator is realized as a time-continuous type with two SC current sources. The current through the resistor of the microbolometer is integrated using the feedback capacitor  $C_{int1}$  of the left OTA. Similar to the analog readout principle a current source subtracts the radiation independent part of the resistor current. This current source is realized by a switching network and the capacitor  $C_{offset}$ . The  $\Sigma\Delta$  principle requires a feedback loop with the output signal which is realized by the 2<sup>nd</sup> SC current source.

The 2<sup>nd</sup> integrator is realized as a time-discrete type with a non-overlapping two phase clock. The output voltage of

the 2<sup>nd</sup> integrator is valid at the end of phase Phi1 and fed into a comparator. The output of the  $\Sigma\Delta$  is digitally filtered using a 3<sup>rd</sup> order sinc-filter.

Over 10000 SD modulators and sinc-filters are integrated for a parallel readout of the microbolometers. A state machine controls the readout circuits and multiplexes the digital output data. The state machine is programmable using an I<sup>2</sup>C bus. A build-in selftest supports the wafer test and reduces test time. The IRFPA is completed by a temperature sensor for calibration issues.

## Conclusion

Two IRFPAs with different array sizes and signal output types have been realized. A first prototype with 160 x 120 pixel and an analog output signal has been electrically characterized. A second IRFPA with 640 x 480 pixel and a 16 bit digital output signal has been designed and is in fabrication. To complete an IRFPA a vacuum package is necessary which is realized as a "chip scale package". For that purpose the microbolometer array will be surroun-

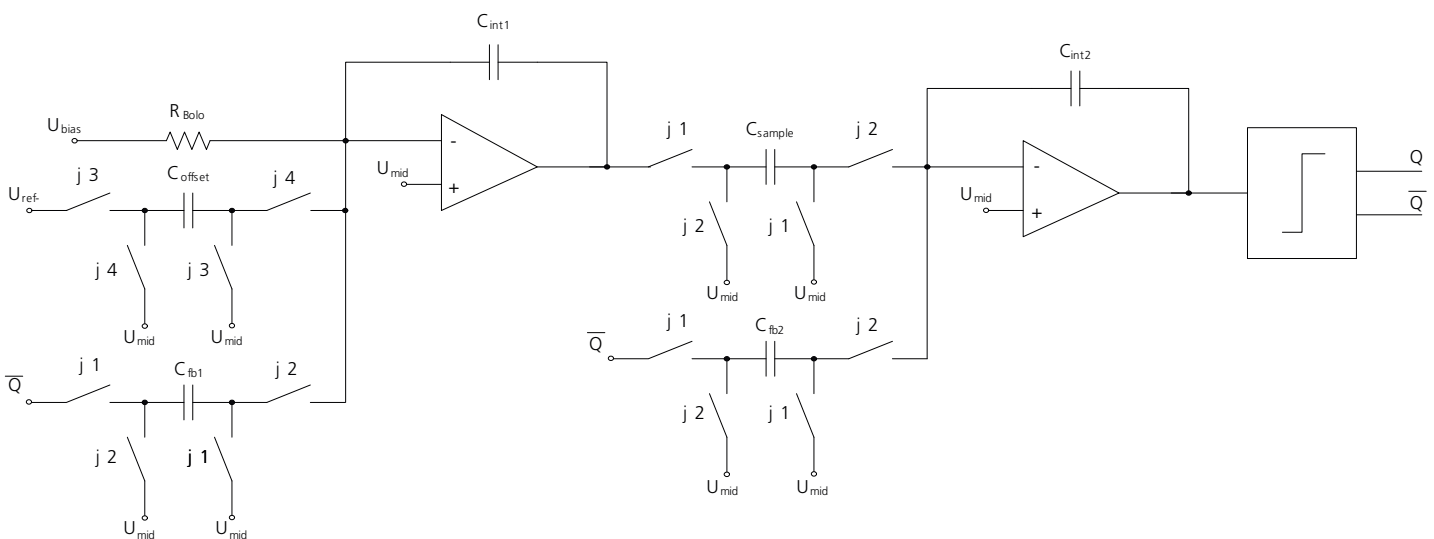

Figure 5: 2<sup>nd</sup> order  $\Sigma\Delta$ -modulator

ded by a lead frame. A lid with an infrared transparent window is bonded under vacuum on the lead frame by a solid-liquid interdiffusion process.

---

## References

- [1] M. Ruß, J. Bauer, and H. Vogt, "The geometric design of microbolometer elements for uncooled focal plane arrays", Proc. SPIE Conference Infrared Technology and Applications XXXIII, Volume 6542, 2007
- [2] F. Niklaus, F. Forsberg, A. Fischer, N. Roxhed, G. Stemme, "Performance model for uncooled infrared bolometer arrays and performance predictions of bolometers operating at atmospheric pressure", Infrared Physics & Technology Volume 51, Issue 3, January 2008, Pages 168-177
- [3] Hwang, C.H.; Kim, C.B.; Lee, Y.S.; Lee, H.C., "Pixelwise readout circuit with current mirroring injection for microbolometer FPAs", Electronics Letters Volume 44, Issue 12, June 5 2008 Page(s):732 – 733

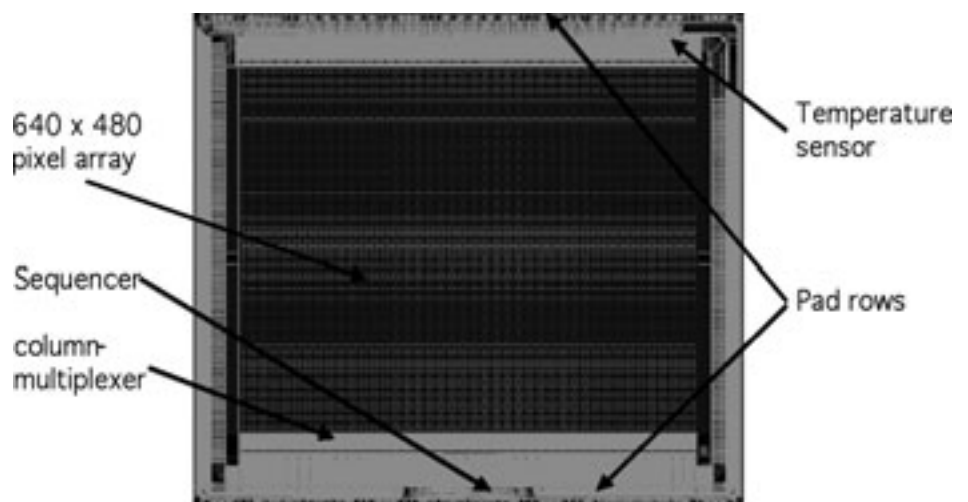

Figure 6: Layout IRPGA with 640 x 480 pixel digital readout

## Introduction

In the last decade, wireless sensor networks (WSNs) have been growing rapidly in various applications. WSNs are typically used for information gathering in applications like habitat monitoring, agriculture and environmental sensing, and health monitoring. The primary functionality of a WSN is to sense and monitor the state of the physical world.

However, in many applications, observing the state of the physical world is not sufficient, it is also expected to interact with the physical world. to the sensed events/data by performing corresponding actions on the system. This stimulates the emergence of wireless sensor/actuator networks (WSANs). The potential applications of such wireless WSANs are widespread, including agricultural maintenance or logistics applications to deliver localized information.

## Agricultural application

Multifunctional devices comprising sensors and transceivers that communicate untethered in short distances are quite attractive for agricultural applications.

This holds true even in today's dairy industry, where only a small amount of time is left to take care about the dairy cows. Hence, first signs of disease are frequently missed.

A wireless measuring system, consisting of sensors and transmission units, helps to keep livestock healthier with a minimum use of resources (Figure 1). The system determines the pH level and the temperature inside the cow's rumen [1]. The data are wirelessly transmitted to an external transceiver node in the animal's collar via an encapsulated measuring probe referred to as bolus. A network of wireless nodes forwards the data to a central database. The bolus contains all of the components needed for connecting the sensors and transmitting the measured data wirelessly (Figure 2). The integrated radio module does fit the small energy consumption requirements (less than 30  $\mu$ W in average) by using an oscillating circuit with a high quality factor. Furthermore, special attention is taken to the communication protocol to improve energy efficiency.

## Logistics application

Changing the prices on supermarket shelves often involves a lot of activities for the employees. Commonly, there is only a small amount of time to change price tags. Even if electronic displays are in use, flash memory cards in the appropriate display have to be replaced.

A system of networked displays enables prices to be updated quickly and at any time from a central computer. To make this possible a wireless transceiver is integrated in each display. Each display can be separately controlled via a transceiver attached to the central computer. From the store management point

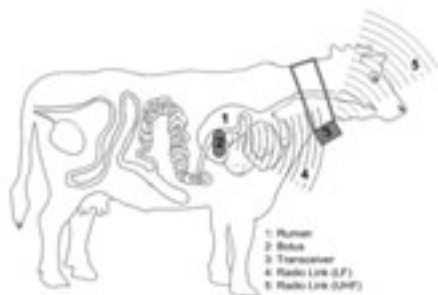

Figure 1: Schematic representation of measuring system.

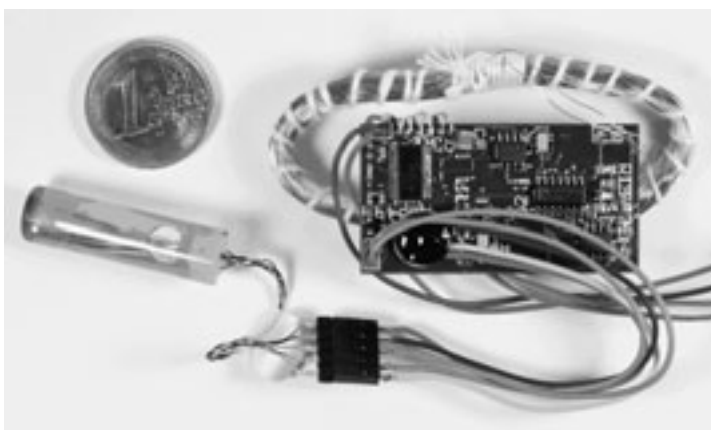

Figure 2: Bolus components (Sensor, Antenna, PCB)

of view, an image file containing the new price information as well as the display address is to be copied into a dedicated part of the file system. The price display on the shelf will be instantly updated. Previous to the transmission the image file is fragmented into small data packages to reduce payload size thus allowing the use of a low power transceiver system. At the receiver side the image file is reassembled, delivered to the display controller and finally displayed on screen (Figure 3). In case of a lost or corrupted data fragment, a specific handshake mechanism will initiate the retransmission of the missing data instead of the entire image file. Due to the low-power design tightly sealed housings can be used, which is an advantage in certain places where displays are installed – for instance in refrigerated shelves where moisture is unavoidable.

---

## Conclusion

The benefit of deploying wireless sensor and actor networks becomes particularly obvious in applications, where wireless nodes collect sensor data from the environment or perform actions on the environment, even in terms of economic efficiency and sustainability. Recent progress in semiconductor technology has enabled the use of low cost wireless sensor and actor networks in real world applications. Nevertheless, applicable design of the components, hardware as well as protocols, is essential to meet application requirements.

---

## References

- [1] Hightech im Kuhmagen, Welt am Sonntag, 14.9.2008



Figure 3: Wireless display

# Feasibility of Deeply Implanted Passive Sensor Transponders in Human Bodies

Andreas Hennig, Gerd vom Bögel

## Abstract

The use of sensor transponder technologies in medicine opens valuable possibilities in therapy of human cardiovascular system diseases, for example cardiac insufficiency. This paper deals with the question, what relevant effects exist concerning energy transmission through the human body and how they can be considered during the system design process. Parasitic effects in the transponder antenna are analysed. Finally, a combination of all effects is taken into account to analyse the frequency behaviour of the whole system. Practical examinations confirm the feasibility with a HF transmission system.

## 1 Introduction

Medical studies [1] have shown that the treatment of cardiovascular diseases can be significantly improved by continuous monitoring of parameters such as blood pressure, temperature, etc. For such diseases, only rigid drug treatments are available yet. The administered doses can not be adapted to a rapidly changing demand. This leads to a drastic reduction of the quality of life. A continuous monitoring of cardiac and circulatory functions can optimise the adjustment of drug dosage. Sensor transponders implanted into the human body can improve a therapy significantly. These transponders can be located in different places in the body, monitoring the performance of the heart circulation system. Such transponders make a cabling of the whole body unnecessary. The dimensions of the transponder should make a catheter-implantation possible. Especially so-called passive transponder systems are of interest, because such implants normally stay inside the body for a longer period. Thus, a supply by a local battery is not

possible. In such systems, the transponder is contactlessly supplied by a field from the reader located outside the body. The maximum possible distance between the reader and the implanted transponder is of interest, e.g. to make such a system suitable for corpulent patients.

One of the most important tasks is to find the best carrier frequency for the energy transmission.

## 2 Limitations and Requirements

The dimensions of an implantable transponder should not be more than several millimetres. Otherwise an implantation by a catheter is not possible. From this it follows, that only small antennas in the shape of a stick are supposed. The induced voltage is proportional to the size of the area encircled from the windings. Losses in the energy transmission through human tissue determine the available energy. Transponders with additional sensors consume significantly more energy than simple id transponders. These facts reduces the maximum possible distance. For this application, the distance can exceed half a meter.

## 3 Preliminary Considerations

Transponder systems usually work with ISM frequencies [4]. For LF and HF transponder systems, the distance of several decimeters is much smaller than the wavelength. This situation is called near field communication. In contrast to LF and HF, the distance for UHF is greater than the wavelength and thus electromagnetic waves exist. The dimensions of an antenna for UHF would be greater than the allowed dimensions. Thus, only LF or HF trans-

ponder systems are of interest here. In such systems, only the magnetic component is used for transmission of energy and data. The antennas for LF and HF systems are made of coils. They could be designed as air coils or ferrite coils. For this application ferrite coils are of interest because they can be made in the shape of a stick and higher inductivities with less space are possible. Ferrite materials with usable parameters up to 13,56 MHz are available.

To lighten the energy supply for the transponder it is essential to find out the optimal frequency. The following frequencies are preferably considered: 133 kHz, 6.78 MHz and 13.56 MHz.

#### 4 Energy transmission through human tissue

In this chapter, the energy transmission to a passive sensor transponder deeply implanted in human body is analysed. Figure 1 shows an example of a model for an implanted sensor transponder near to the heart and a corresponding reader.

The coil of the reader produces an alternating magnetic field. A small part of the magnetic flux couples with the transponder coil. In consequence, a voltage is induced in this coil. With this voltage the electronic of the transponder is supplied with power.

##### 4.1 Absorption Effects in Human Tissue

The reader consist of a transmitter that produces an alternating magnetic field with an antenna and a receiver for the transponder data. Figure 2 shows an simplified circuit of the transmitter part. A power amplifier produces a sinusoidal voltage with the carrier frequency.

A parallel resonant circuit composed of a coil and a resonant capacitor is driven by this voltage. In case of ideal lossless elements, no current flow between the amplifier and the resonant circuit takes place during oscillation. The current flow between the coil and the capacitor is called idle current and is causer of the magnetic field around the coil. When a transponder or conductive material is placed near to the coil, the oscillation of the resonant circuit is damped. To keep the oscillation alive, the power amplifier has to provide energy and balances the losses in the resonant circuit. Normally, the energy consumption of the transponder is insignificant compared to the losses in conductive environment and in unideal electrical elements.



Figure 1: Model of an inductive sensor transponder system for medical applications (X-ray picture: Deutsches Röntgen-Museum)

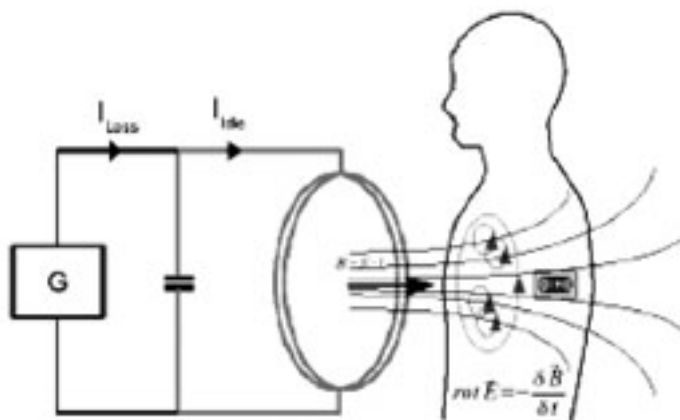

Figure 2: Eddy Current in tissue caused by magnetic field changing in time

When a human body is located near to the reader, the magnetic field penetrates the human tissues. Inside the tissues a voltage is induced. This is described by the Maxwell's 2nd law. Dependent on the conductivity of the tissue at the carrier frequency a eddy current occurs. This current conduction is circular and in a layer vertical to the direction of the magnetic field. These currents generate a magnetic field with opposite orientation weakening the magnetic field of the reader. The absorption of the magnetic field increases with the conductivity of the material. This conductivity is frequency dependant and can be calculated by a modell described below.

Simplified, the molecules of tissue can be considered as dipoles. When an electric field is applied, the dipole orientation is modified. This electric field is caused by the time variant magnetic field. This dipolar polarisation is a rather slow phenomenon. The saturation of

the polarisation is reached after some time. It is described by a time constant  $\tau$  called relaxation time. For tissue, faster phenomena such as resonance only exist at higher frequencies, that are not of interest for this application. For very low frequencies, the dipoles can follow the applied field without relaxation effects. The losses are low as well. When the frequency rises, the orientation of the dipole is delayed. The material is lossy.

To analyse the frequency behaviour of the losses, a simulation was performed with a 3D field simulation tool. This software can calculate electric and magnetic fields based on the finite differences time domain method (FDTD). The method is based on the discretization of the Maxwell equations in order to calculate the magnetic and electrical fields numerically. Additionally, the currents and voltages versus time can be determined. A simple model of the human body with all tissues between the reader and the transponder coil was implemented. In the following it is called inhomogeneous Model. This simple model consists of cuboids that represents every different kind of tissue that is between the coils. The cuboids consider the different volumes and layers. Thus, the simulation is more realistic, because the losses are proportional to the volume as portrayed before. The parameters evaluated from the Cole-Cole dispersion were incorporated into the model as well. Figure 3 illustrates the approximation of the volume information of several kinds of tissues with the help of an x-ray picture in an 2D view. The picture shows a cross section of human body in the layer of the heart. To generate a field and measure the induced voltages, a reader and a transponder coil were modelled. This technique offers an easy and fast way to get a realistic idea about the frequency behaviour of the losses. To extract the information about the losses

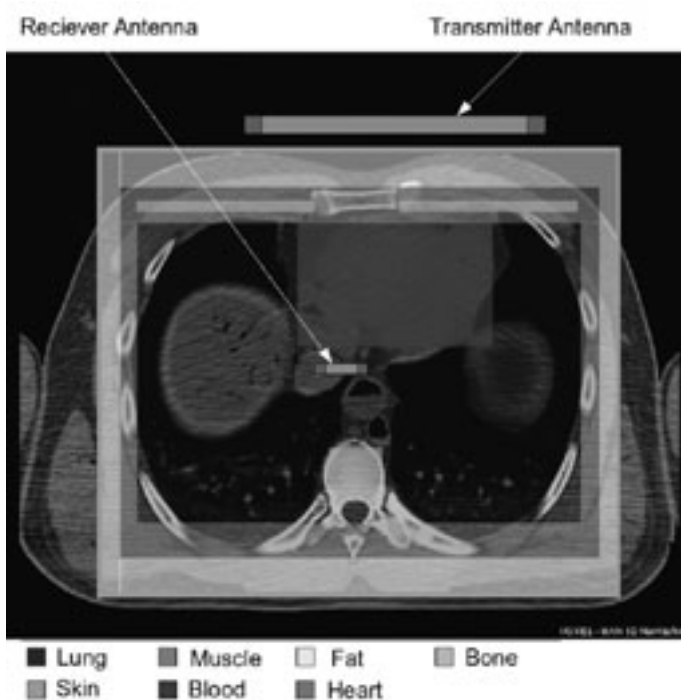

Figure 3: Aproximation of volumina  
(X-Ray Picture: Deutsches Röntgen-Museum Germany)

and to separate it from antenna specific effects, three simulations were performed. For all three simulations, the induced voltage at the transponder coil over the frequency was calculated. As a reference, the first simulation was done for a transmission through air. That means there are no losses. The second simulation was performed with the parameters specific for every kind of tissue and every frequency. The third simulation represents a "worst case". There, a homogeneous model was used with only one kind of tissue. The parameters of blood were chosen, because the conductivity of blood is greater than of other tissues. The voltages induced in the second and third simulations were divided with the values of the reference simulation in air. This quotient shows the losses in the tissue.

In Figure 4, the voltage induced at the transponder coil, reduced by eddy currents in tissue, is compared to the voltage induced with air surrounded. If there is no tissue between the coils, the quotient would be one for all frequencies. First of all, the curves show that the quotient decreases with increasing frequency. For the homogeneous model, there is only 25 % less of the induced voltage compared to an transmission over air at 13 MHz and 76 % less at 40 MHz.

#### 4.2 Frequency Behaviour of Induced Voltage at the Transponder

In contrast to the frequency depending absorption effects, the induced voltage at the transponder coil increases with the frequency in accordance with the induction law. Moreover, matching between the coil impedance and the load impedance of the transponder electronic causes different possible voltages for each frequency. Over all, an optimum frequency can be found, at which a maximum energy can be transmitted

through the tissue. This chapter shows how to calculate the maximum possible voltage at each frequency combining all effects. These effects are the loss effects in tissue, the induction law, and parasitic effects in the transponder. After that, an optimum frequency can be found with the largest energy transmission range by minimum transmission power.

The voltage induced in the transponder coil is used to provide the power supply to the transponder electronic. Figure 5 shows the equivalent circuit of the transponder.

The resistor  $R_i$  represents the natural resistance of the transponder coil  $L_1$  and the current consumption of the transponder electronic is represented by the load resistor  $R_L$ . If a voltage  $U_i$  is induced in the coil  $L_1$ , the voltage  $U_L$  can be measured at the load resistor  $R_L$ . It is a result of the voltage  $U_i$  minus the current  $i$  multiplied with the coil impedance and  $R_i$ . The so called quality factor represents the relationship between the induced voltage at  $L_1$  and the voltage at the transponder electronic. A higher quality factor causes a higher voltage  $U_L$  and a higher maximum distance between reader and transponder.

By analysis of the circuit it can be seen, that for every pair of  $R_i$  and  $R_L$  there is a  $L_1$  at which the quality factor is at its maximum. And this maximum value of the quality factor is different for every frequency. So if the optimal  $L_1$  is calculated for every frequency, the maximum possible quality factor versus frequency could be calculated. However, before this calculation is done, it is necessary to take a closer look at  $R_i$ . It is not constant with frequency. For higher frequencies not all of the wire cross section is used for current flow because of the so called Skin Effect. The induced voltage  $U_i$  is reduced by the loss effects

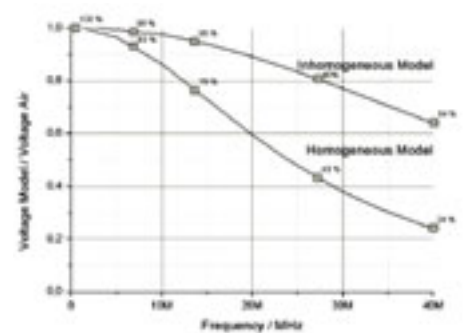

Figure 4: Frequency behaviour of losses caused by eddy current in tissue

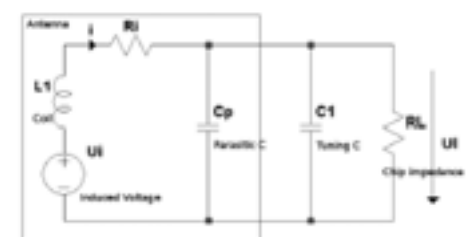

Figure 5: Equivalent Circuit of a Transponder

described in chapter 4.1. Because  $U_i$  is proportional to the quality factor, it is allowed to multiply the quality factor calculated with 4 together with the results of the graph's in figure 4. Figure 6 shows the evaluation of equation 4 considering the effects described before. The parameters of an antenna with the required dimensions and a load resistor  $R_L$  of 100 kOhm was used, that is an empirical value.

First of all, a great difference in inducible voltages between LF and HF frequencies can be seen. For low frequencies, the quality factor is much

smaller than for the HF case. The simulation shows a maximum quality factor for all simulations between 7 MHz and 9 MHz. If the coils are surrounded by air, there will be an optimal frequency of about 9 MHz. This optimal frequency becomes lower, when human tissue is between the coils. For the homogeneous model, in worst case, an optimal frequency is about 7 MHz. It can be said, that the human tissue reduces the optimal frequency value, at which the most voltage can be induced respectively the highest transmission range could be achieved. The optimal frequency can be observed near to the 6,78 MHz ISM band. A carrier frequency around 6,78 MHz is optimal for our constraints, if an ISM Band shell be used.

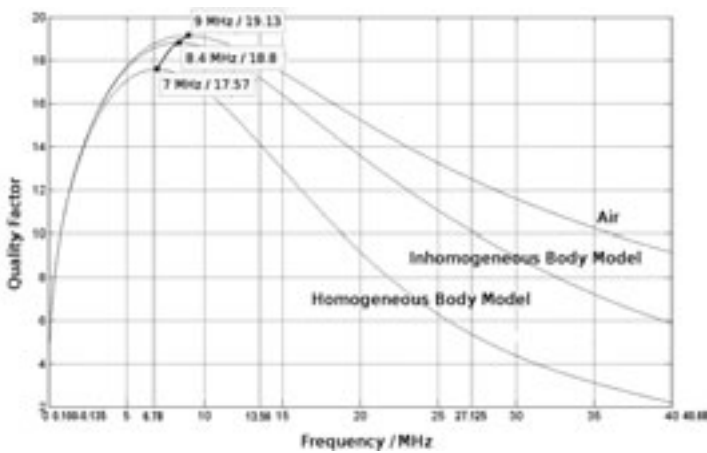

Figure 6: Influence of the human tissue to the optimum frequency

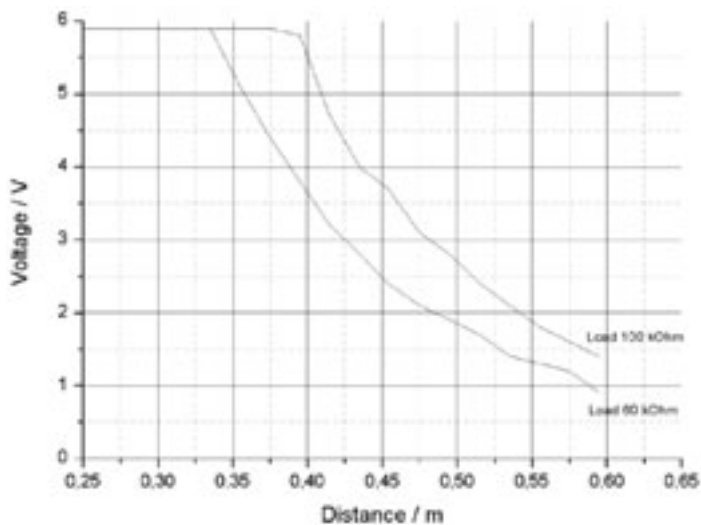

Figure 7: Distance measurement

## 5 Experimental examination

An experimental measurement shall show, that a sensor transponder can be provided with enough energy inside human body tissue and shall determine the maximum achievable distance. For this experiment, a circular coil with a single winding and an aperture of 26 cm was used to produce the magnetic field. A frequency of 13,56 MHz was chosen. A test transponder was developed to measure the energy that can be provided to an implanted transponder. To create a substitute that simulates the electric properties of the human body, a phantom substance was prepared following a recipe described in [2]. The main goal of the experiment is to measure the voltage induced at the transponder coil when it is placed inside this substance at different distances from the reader coil. It was placed in a container large enough to allow the transponder to be placed in a similar position as in a human body. The chip used in sensor transponders usually works with voltages greater than 3 V. Therefore, the

transponder would be provided with enough energy at a distance where the voltage is still higher than this voltage. Figure 7 shows the measurement results.

The measurement was performed with an idle current of about  $I_{eff} = 5$  A in the reader coil and a load resistor in the test transponder of 60 kOhm and 100 kOhm. These values were chosen empirically. The voltage is greater than 3 V for distances up to 48 cm.

The experimental measurement shows that a sensor transponder can work inside human tissue up to a distance of 48 cm.

## 6 Conclusion

Passive sensor transponders, deeply implanted in human bodies, are feasible. For the given constraints to the transponder antenna, an optimal frequency could be found. The loss effects decrease this optimum frequency. A carrier frequency around 6,78 MHz is an optimal choice for our constraints.

## References

- [1] Priv.Doz. Dr. Andreas J. Morguet, Paul Kühnelt, Antje Kallel, Dirk Russ, Marcus Wähner, Prof. Dr. Heinz-Peter Schulteiss; Telemedizinische Betreuung und Überwachung von Patienten mit gering bis mittelgradiger chronischer Herzinsuffizienz in der häuslichen Umgebung; AAL-Kongress 2008
- [2] S Gabriel, R W Lau und C Gabriel; The dielectric properties of biological tissue; Phys. Med. Biol. 41 (1996) PP 2271-2293
- [3] A. V. Vorst, A. Rosen, Y. Kotsuka; RF/Microwave Interaction with biological Tissues; John Wiley & Sons Inc.; Canada USA; 2006
- [4] Klaus Finkenzeller; RFID-Handbook; Hanser; München Wien; 2006
- [5] Standard Test Method for measurement of radio frequency induced heating near passive implants during magnetic resonance imaging; ASTM International; West Conshohocken, PA, 2002

# Micro-Reactor Systems

Robert Klieber, Burkhard Heidemann, Hoc Khiem Trieu

## Abstract

Micro-Reactors are small chemical reactors, which are typically a few centimetres long with channels of up to 100  $\mu\text{m}$  in diameter. These Micro-Reactors are made up of materials such as glass or silicon. There are several benefits of scaling down synthetic reactions. Due to the small dimensions heat and mass transport has a higher efficiency. A higher selectivity in reactions can be achieved by an accurate and faster control of the temperature. The high surface-to-volume ratio results in a more specific reaction and shortened reaction time enabling a higher selectivity in reactions and making it more cost efficient. A collaboration with the University of Nijmegen and Wageningen (Netherlands) was started to develop a Micro-Reactor System for the application in organic chemistry. The result is a new plug-and-play Micro-Reactor System for the chemical synthesis.



Figure 1: Picture of a micro fluidic chip.



Figure 2: Picture of the Micro-Reactor Control System

## Introduction

Reactions performed in Micro-Reactors (Figure 1) generate relatively pure products with high yield in much shorter times and in sufficient quantities in comparison to the equivalent bulk reactions. This can be used to characterize reaction conditions faster and cost efficient. There are numerous applications for Micro-Reactors ranging from biomedical diagnostics, enrichment of valuable constituents, carrying out dangerous reactions, etc. Micro-Reactor Systems can be used to acquire process information for process engineering purposes or used within Research & Development. Therefore a micro-scale processing system has been designed to enable flexible processing. This system comprises hardware like a control unit, micro fluidic chips, a chip-holder, syringes on syringe pumps, different connections between the parts of the system and software as well.

## Micro-Reactor System

Reactions performed in this system are continuous flow reactions, which means that the chemical reaction is performed as a continual process. Reagents are continually added to the input of the reactor and product is continually collected from the output and can be analysed for example by liquid chromatography or mass spectroscopy afterwards. To provide a constant flow rate of the different reactants the Micro-Reactor System can communicate with peripheral equipment such as pumps to enable immediate monitoring of the pressure within the syringes including the reagents and therefore in the micro fluidic chip. Temperature control is of utmost importance for chemical processes. Therefore temperature

measurement and control of the micro fluidic chip is implemented in the Micro- Reactor System (Figure 2) to enable monitoring and controlling of the temperature for chemical reactions. Coupling electronic technology to the micro fluidic chip makes automation possible to enhance and characterize chemical processes. The optimization time of reactions can be shortened, which will reduce the time to market.

For automatic probe collection a robot (Figure 3) can be controlled by the Micro-Reactor System. Complete experiments with different sets of parameters (pressures, temperatures, reactants) can be carried out. The chemical output is collected in different vials and analysed afterwards for example by mass spectroscopy to find the best combination of parameters. This information can be used in lab-scale experiments or plant-scale production for mass production later on.

---

## Summary/Conclusion

As a part of a Euregio project a new Micro-Reactor Control System has been developed. It comprises a chip holder to connect pressure driven syringes to it. Temperature and pressure can be monitored by sensors attached to the holder and the syringes. The integration of a sampling robot provides a totally automated system. Due to its high accuracy this system offers a reliable tool for research purposes in the chemical and biological industry. FutureChemistry BV as a new founded spin-off company is currently bringing the system to the market.



Figure 3: Picture of the automated Micro-Reactor setup to optimize industrially relevant reactions. This system can be used as an initial screening before large scale optimization saving costly chemicals.

## Abstract

This paper describes a holistic IT-system for the support of logistic processes on construction sites. Automatic identification of building materials provides the possibility for the linkage of information from the internet. While the identification system combines technologies like barcode, LF and UHF transponders, the linked information are stored in an EPC (Electronic Product Code) compatible way and can be used i.e. for product specific construction instructions or for the calculation of facility management ratios. Thus the system supports the whole supply chain and was evaluated with facade cladding elements during the construction of the inHaus2, which is a research facility with total area of more than 4000 m<sup>2</sup>.

## 1 Introduction

To run construction projects in an economically efficient and accident-free manner, the coordination of planning and manufacturing processes is of utmost importance. Nowadays, only few of the materials available on the premises of a construction site are labelled with machine-readable identification tags. Thus it is extremely difficult for the workers and for the site managers to track material supply quantities or to handle the installation of new products or materials in a proper way. This being the case, certain undesirable physical effects such as sound bridges, low surface temperatures (defrost water and mildew), air bridges, equipment incompatibilities, and corrosion the damage in the structure of the building amounts to millions of euros. In addition, the actual execution of tasks by the workers is not sufficiently docu-

mented such that in case of a dispute between the owner and the construction company it is hard to track down construction errors. A solution can be the employment of an IT supported identification systems used in other sectors of the economy. There, such systems have become an integral part of the complex processes in order to provide helpful information about the stations of the supply chains, the planned routes, the delivery dates, etc. Furthermore, the technical requirements for storage, handling and transportation could be just as easily carried with the products as the installation instructions and the acceptance protocols. Nevertheless, existing solutions are not directly transferable to the building and construction industry. To do so, special considerations regarding the unique characteristics of the construction site and the lifetime of the project have to be taken.

The used solutions for production planning and controlling for the construction sector are cut very poor on these issues. They are limited to the dimensioning of needed manpower and equipment. Thus, what is called for is a system that supports the processes of material provisioning, stocking and finally utilization. The huge amounts of incidental information, which is gathered by RFID readers, must be evaluated, saved, and made available for all relevant persons. The static and dynamic information of the building with the completion and acceptance in form of a digital facility record is committed to the owner and can be used for the future facility management.

A further goal is to combine the characteristics of the building materials in order to generate automatically an estimate for the characteristics of a whole "functional unit", e.g. the facade of a building [1], [2], [3].

## 1.1 Benefits in the manufacturing phase

For each facade cladding element, different materials are processed. Using RFID tags, key data can be linked together (see figure 1) and lead to further component indicators, such as the heat loss factor also known as the U-value. Veneer parameters, such as "air tightness" are only significant with the consideration of the installation. Combining the facade parameters and installation parameters, the parameters of the "functional unit" can be deduced.

## 1.2. Benefits in the installation phase

By doing a comparison between the nominal and actual materials that are delivered to a building site, the construction quality can be assessed and characterized. Furthermore, the documentation of each step during construction can help to evaluate the proper assignment of qualified staff and the use of appropriate system components. Together with other data, the so called digital facility records are generated and maintained (see figure2).



Figure 1: Manufacturing process [1], [2]

## 2 Analysis of contemporary construction sites

### 2.1 Process chain

The considered process chain starts with the issuing of the facade elements from the manufacturer's site. These are then transported on trucks to the construction site, where a nominal vs. actual comparison is done. In the next step, the facade cladding elements are installed by the workers. The process chain ends finally with the facility management.

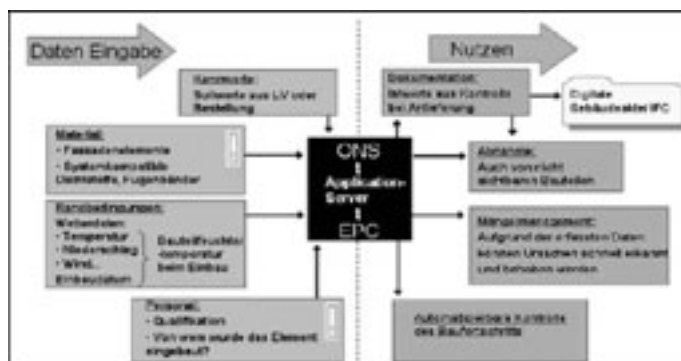

Figure 2: information chart over installation [1], [2]

## 2.3 Facade issuing

Dependent of the facade dimensions, two or three elements are stacked on crates for storage and transportation (see figure 3). There exists no IT assistance for the comparison of planned production data and actual production data. To achieve this, the elements have to be RFID tagged. The tags can be mounted on different places on the facade elements, for example: on the cladding metal frame or the heat absorbing glass panel. Another possibility is the tagging of the transport crates.



Figure 3: two bundled crates with facade elements in the field storage [3]

## 2.4 UHF RFID Gate

The largest used facade cladding elements have dimensions of 4 x 6 meters. This determines the minimum size of the UHF RFID gate. As a UHF RFID gate, a cable bridge with the dimensions of 8 x 6 meters has been chosen (see figure 4). It is large enough to meet the needs of the transport traffic on the construction site, and in particular of the facade delivery.



Figure 4: RFID Gate at construction site access road [3]



Figure 5: creating a shipment ticket [3], [4]

## 3 System Integration

In a first step, an IT infrastructure, which is unusual for contemporary construction sites, has been established at in-Haus2. It consists of an area-wide WLAN network, a cell based and a RSSI based people tracking system, DSL high speed Internet connection, several stationary and mobile web cams, ZigBee Sensor Networks, an UHF RFID gate, several mobile LF- and UHF-Reader handheld units. In addition, a central Web platform, on which the construction site Web portal ("Baustellenportal") as well as numerous Web services are running, has been deployed. Another unique feature of the inHaus2 site are the active and passive sensor transponders for temperature, pressure, force and humidity measurements, which have been set in the concrete of the building.

### 3.1 Issuing of facade elements from the manufacturer's site

The facade manufacturer has an internal barcode solution to support its own manufacturing process. On top of this barcode system, in which each facade cladding element has an unique barcode label, the elements for the inHaus2 construction site have been equipped with additional LF transponders. The used materials (e.g. metal, glass panel, gasket, etc.) with their own material properties are associated to the unique ID in the manufacturer's system. This unique ID is printed and placed as barcode on the cladding truncation or the glass panel. After installation of the elements, though, the barcodes are inaccessible. For the later acceptance of the installation work and for the maintenance of the facade, the LF transponders are mounted on the inner side of each element.

A carrier, also called, crate can carry up to four facade elements. The LF transponders and/or barcodes of the elements that have been loaded on the crate are linked to the UHF transponder, which is mounted on the crate. Thus, a mapping between the crate and its carried elements is created. This is done with the help of the application depicted in figure 5. It runs on a mobile reader unit, which is equipped with a barcode scanner, LF-Reader and UHF-Reader. The following figures show the bundling of elements at the manufacturer's site before these are shipped. First a new delivery is opened, and using the address a shipment ticket is created.

Then, the barcode or LF transponders from the facade elements are scanned and linked to the UHF transponder of the crate.

Each truck that is involved in the shipping process is equipped with a GPS-Box, which has been additionally tagged with an UHF transponder. After all crates have been loaded on the truck, a mapping between the trucks GPS transponder id and the loaded crates is stored in the system. By doing this, the construction site manager and the manufacturer are able to track the locations of the shipments.

The completed shipment information consists of the planned delivery date, the delivery address, the loaded crates with the corresponding cladding elements and the GPS id of the truck. This information is send over the Internet to the in-Haus2 construction site portal.

### 3.2 Facade delivery at inHaus2

The Reader from the UHF gate is connected over the area wide WLAN to the construction site Web portal. Upon delivery, the ids of the detected crate

UHF transponders are persisted in the system. In addition, the construction site manager is automatically notified about the delivery of the shipment with the help of an SMS message.

### 3.4 Acceptance of facade installation and generation of the functional unit

After installation, the acceptance procedure is carried out by the construction site manager. The facade elements are scanned with the handheld unit and he/she is able to accomplish the nominal vs. actual comparison. The construction manager gets direct access to installation details, manufacturer information, function coat, edge bond, glazing assembly etc. and he/she can judge the quality of the installation work. Remarks and considerations are written in the digital facility record. Having information about the properties of the installed materials as well as the grade of the installation quality, the parameters for the functional unit (e.g. the facade as a whole) can be calculated.

### 3.5 Facility management

For documentation, the facility manager uses a handheld LF reader unit with WLAN access. Available maintenance information, which is retrieved from the digital facility record, is displayed on the handheld. To enter new information, the facility manager has to identify himself/herself. This is done with the help of an identification badge. After login, the LF transponder of the facade element, which is being serviced, is scanned. Remarks regarding the maintenance procedure can be entered or information from previous service routines can be retrieved from the digital facility record and displayed.

Figure 6 illustrates a selected heating facade with the corresponding input panel for the maintenance. The state of the components of the facade element can be marked as being "OK" or "Not OK" and in the text field additional notes and comments can be saved.

### 3.6 Information management

The information management over the material flow is illustrated in figure 7. The order and delivery information is directly sent from the manufacturer to the construction site portal. There, each shipment can be located using the GPS coordinates of the trucks. Upon arrival, the truck passes the RFID gate and a notification about the goods delivery is issued to the construction site manager. During the installation process, the workers document the mounting of

each facade element by using the handheld reader devices. This information is accessible for the acceptance of the installation work and for the later facility management.

## 4 Acknowledgements

This work is supported through the BBR and the inHaus2 partners Hochtief AG, T-Systems AG and Gartner GmbH.

## 5 Literature

- [1] FhG IMS/IBP: RFID Kennzahlen
- [2] www.rfidmbau.de
- [3] FhG IMS
- [4] „Kennzahlen und Bauqualität“; Gerd vom Bögel; Berlin 2008;
- [5] www.inhaus-zentrum.de
- [6] „Einführung von RFID-Technologie im Bauwesen – neue Perspektiven für mehr Qualität“, Norbert König, FhG IBP



Figure 6: maintenance of facade cladding elements [3]

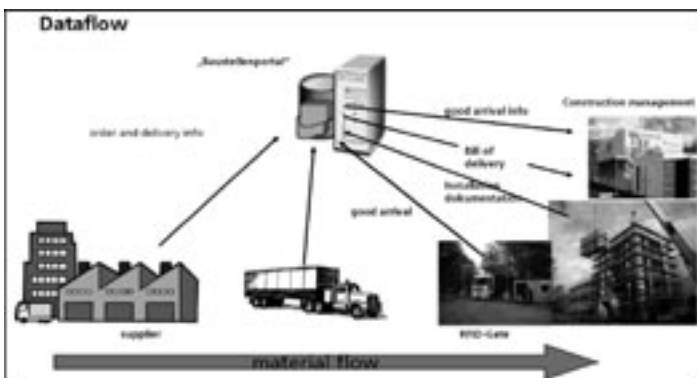

Figure 7: dataflow from supplier till construction manager [4]





List of Projects  
IMS Duisburg

# List of Projects

## IMS Duisburg

Project Title	Partner	Project Period
Pulse Generator	Industry	07/1996–07/2010
Production High Voltage SOI-CMOS	Industry	01/2003–09/2009
Foundry IVTMX	Industry	04/2004–12/2008
Delivery CMOS Imager	Industry	05/2004–07/2008
Delivery REOS	Industry	10/2004–12/2008
ASIC Production	Industry	01/2005–12/2014
Development of technology robust IP cores	Industry	05/2005–04/2008
Quartz Wafer	Industry	05/2005–12/2008
CMOS Technology R&D	Industry	01/2005–12/2014
CMOS Production	Industry	01/2005–12/2014
Spectroscopy CMOS Sensors	Industry	08/2005–03/2009
ASIC Development Pressure Sensor	Industry	03/2006–06/2009
Delivery of Memory Tag III	Industry	10/2005–12/2008
Delivery OA32	Industry	09/2005–12/2009
MILDS Sensor	Industry	08/2007–08/2009
MILDS Sensor Development	Industry	02/2004–11/2008
IP Exchange	Industry	07/2006–06/2008
Consulting for Heating Systems	Industry	09/2006–12/2008
Foundry IODS P2	Industry	09/2006–12/2008
Foundry Service	Industry	12/2006–12/2008
inHaus Basis Contacts	Industry	01/2007–12/2010
TADS	Industry	02/2007–12/2008
MIMOS II	Industry	02/2007–12/2008
Sensor Transponder	Industry	03/2007–11/2008
UTSD Modul	Industry	03/2007–08/2008

SOI-CMOS Process	Industry	04/2007–03/2009
Concept High Frame Rate Imager	Industry	05/2007–02/2008
Development RFID Reader	Industry	05/2007–01/2008
Development Smart Home Controller	Industry	11/2007–06/2008
Reader for Pressure Sensor Tag	Industry	07/2007–12/2008
Demonstrator RF	Industry	07/2007–10/2007
ADC Self Test	Industry	08/2007–11/2008
EEPROM Technology Development	Industry	09/2007–11/2009
Infrastructure inHaus 2	Industry	03/2007–07/2008
Production RF ASIC For Longer Range	Industry	09/2007–06/2008
Study High Frame Rate Imager	Industry	08/2006–01/2007
LON Interface for Heating Systems	Industry	08/2006–04/2007
Production RF ASIC For Longer Range	Industry	09/2007–02/2008
Production Triangulation Sensor	Industry	01/2005–12/2009
SOI-CMOS Production	Industry	06/2007–12/2008
Process Documentation inHaus	Industry	08/2007–12/2007
Development Software MOD 3000 I	Industry	03/2008–09/2008
Pressure Sensor Tag	Industry	10/2007–12/2008
Smart Meter Hardware	Industry	04/2008–05/2008
Development CMOS Imager PROVIPS	Industry	10/2008–09/2010
People Tracking	Industry	11/2007–08/2008
Study Imager Pixel	Industry	11/2007–04/2008
Wireless Displays	Industry	11/2007–03/2008
Study Strain Gauges	Industry	11/2007–03/2008
Development High Frame Rate CMOS Imager	Industry	12/2007–05/2010
4th CMOS Imaging Workshop	Industry	01/2007–12/2008

Backendprocess	Industry	12/2007–12/2008
MPS Transponder System	Industry	01/2008–12/2008
Demonstrator LON Pyxos	Industry	01/2007–02/2008
Delivery CMOS Imager	Industry	01/2008–11/2008
Study Specification MUC	Industry	01/2008–02/2008
Study 3D Sensor	Industry	03/2008–11/2008
Development Cash Box Transponder	Industry	03/2008–11/2008
Flexray Conformance Test II	Industry	03/2008–04/2008
Development SoC Demonstrator	Industry	06/2008–11/2008
Study Intelligent Work Place	Industry	06/2008–11/2008
Piezo Resistive High Pressure Sensor	Industry	07/2008–08/2009
Study SRAM IV	Industry	07/2008–12/2008
Building Front Tracking	Industry	01/2008–11/2008
Development Of Technology Robust IP Cores II	Industry	08/2008–12/2008
Consulting for Heating Systems	Industry	08/2008–11/2008
Development Retina Implant	Industry	08/2008–05/2011
Development Software MOD 3000 II	Industry	08/2008–09/2009
Terra Hertz Imaging	Industry	07/2008–06/2009
Study SRAM V	Industry	09/2008–11/2008
inHaus II Energy Efficiency UC	Industry	09/2008–11/2008
Support Amorphous Silicion 2	Industry	10/2008–12/2008
Process Development CMOS 3D	Industry	10/2008–02/2010
Support Layout	Industry	10/2008–12/2008
Development Master Modification for Heating Systems	Industry	11/2008–12/2008
Development Master Modification for Heating Systems	Industry	10/2008–12/2008

Patent	Funding Authority EC	01/2004–06/2008
Micro Reactors	Funding Authority: Investions-Bank NRW	01/2008–09/2008
Amigo	Funding Authority EC	09/2004–02/2008
Development of CMOS process integration for MRAM EMAC	Funding Authority EC	09/2005–11/2008
Wireless Stabling - WISTAB	Funding Authority: Investions-Bank NRW	07/2006–07/2008
Sensor Data Fusion of 2D/3D Imager MIDIAS	Funding Authority: VDI/VDE	06/2006–05/2009
RFID Operation Function	Funding Authority: BBR	10/2006–02/2008
Smart pipe	Funding Authority Projekträger Jülich	01/2006–06/2008
RFID IMS encoding	Funding Authority: BBR	10/2006–02/2008
Inhaus II	Funding Authority Projekträger Jülich	10/2006–06/2008
Sensor Platform for Molecular Medical Sensors IMIKRID	Funding Authority: VDI/VDE	06/2006–05/2009
IMKA	Funding Authority: VDI/VDE	04/2007–07/2008
Gender Mainstreaming	Funding Authority: Investions-Bank NRW	04/2007–06/2008
IR Camera FIRCAM	Funding Authority: VDI TZ	11/2007–10/2010
Smart Forest	Funding Authority: BLE	11/2007–10/2010
EMSIS	Funding Authority: BMBF	09/2007–12/2008
MiniSurg Miniaturised Stereoscopic Distal Imaging Sensor	Funding Authority EC	06/2008–05/2010

Amigo	Funding Authority EC	09/2004–02/2008
Jutta Just in Time Assistance	Funding Authority: DLR	10/2008–09/2011
COMPASS Transponder for Blood Pressure Measurement	Funding Authority: VDI/VDE	09/2008–08/2011
Consulting LDS	Funding Authority: Local Government NRW,	08/2008–07/2009
FFM Super Cam	Funding Authority: DLR	09/2008–12/2009
FFM Angiocam	Funding Authority: DLR	09/2008–12/2009
BIOPROM Development of marker free biological detection	Funding Authority: BMBF	01/2008–12/200
Blood Camera	FhG defined Project	01/2007–12/2008
Assistant Systems	FhG defined Project	10/2007–09/2012
RF Object Localisation	FhG defined Project	10/2005–06/2008
Distributed Smart Objects for logistic Applications	FhG defined Project	01/2006–12/2008
Future Chemistry	FhG defined Project	03/2008–08/2009
Simulation for Process Variation	FhG defined Project	02/2008–01/2011
Development of Indoor Localizations System	FhG defined Project	10/2008–09/2010

## List of Publications and Scientific Theses 2008

## 1. Journal and Conference Papers

Deiters, W.; Hartmann, A.; Scherer, K.:

**Das Projekt SmarterWohnenNRW – IT gestützte Mehrwertdienste auf der Basis vernetzter Haustechnik.**

(Kongress Ambient Assisted Living <1, 2008, Berlin>).

In: Ambient Assisted Living. Berlin [u.a.]: VDE-Verl., 2008, pp. 59–62

Dimitrov, T.; Pauli, J.; Naroska, E.:

**Structured learning of component dependencies in Aml systems.**

(International Conference on Intelligent Agent Technology <2008, Sidney>).

In: 2008 IEEE WIC ACM International Conference on Web Intelligence and Intelligent Agent Technology. Piscataway, NJ: IEEE, 2008, pp.118–124

Durini, D.; Brockherde, W.; Hosticka, B. J.:

**Charge-injection photogate pixel fabricated in CMOS silicon-on-insulator technology.**

In: International journal of circuit theory and applications 36 (2008)

<http://www3.interscience.wiley.com/journal/121375861/abstract?CRETRY=1&SRETRY=0>

Durini, D.; Özkan, E.; Brockherde, W.; Hosticka, B. J.:

**Highly sensitive UV-enhanced linear CMOS photosensor.** (ESSCIRC <34, 2008, Edinburgh>).

In: ESSDERC ESSCIRC 2008. Bristol [u.a.]: IOP Publ. 2008, pp. 118–120

Durini, D.; Brockherde, W.; Ulfing, W.; Hosticka, B. J.:

**Time-of-Flight 3-D imaging pixel structures in standard CMOS processes.**

In: IEEE Journal of Solid-State Circuits 43 (2008) 7, pp. 1594–1602

Ekwinski, G.; Goehlich, A.; Trieu, H.-K.; Rymuza, Z.; Koszewski, A.:

**AFM testing of the nanomechanical behaviour of MEMS micromembranes.**

(European Symposium on Nano-Mechanical Testing <8, 2007, Hückelhoven>).

In: International Journal of Materials Research 99 (2008) 8, pp. 879–882

Fassbender, H.; Urban, U.; Görtz, M.; Trieu, H.-K.; Mokwa, W.; Schmitz-Rode, T.:

**Fully implantable blood pressure sensor for hypertonic patients.**

(Conference on Sensors <7, 2008, Lecce>).

In: IEEE Sensors 2008. Piscataway, NJ: IEEE, 2008, pp.1226–1229

Feldengut, T.; Wang, J.; Kolnsberg, S.; Kokozinski, R.:

**An analog front end for a passive UHF transponder with temperature sensors.**

(European Microwave Conference <38, 2008, Amsterdam>; European Microwave Week <11, 2008, Amsterdam>).

In: European Microwave Week 2008. Piscataway, NJ: IEEE, 2008, pp. 1200–1203

Feldengut, T.; Wang, J.; Kolnsberg, S.; Kokozinski, R.:

**A passive long-range UHF transponder with integrated temperature sensor.**

(European Workshop on RFID Systems and Technologies <4, 2008, Freiburg>).

In: RFID SysTech 2008. Berlin [u.a.]: VDE-Verl., 2008, without pagination

Feldengut, T.; Hennig, A.; Kolnsberg, S.; Kokozinski, R.:

**Wireless power transmission in sensor transponder systems.**

(Wireless Congress <2008, München>).

In: Wireless Congress 2008. Poing: WEKA Fachmedien, 2008, without pagination

Grinewitschus, V.:

**Assistenten für alle Lebenslagen.**

In: Elektrotechnik Jubiläumsausg. „Die Zukunft gestalten – Antworten der Elektrotechnik“ 90 (2008) 6, pp. 80–83

Grinewitschus, V.; Meyer, W.:

**Assistive Technologien für die Optimierung der stationären und ambulanten Betreuung von Personen.**

(Kongress Ambient Assisted Living <1, 2008, Berlin>).

In: Ambient Assisted Living. Berlin [u.a.]: VDE-Verl., 2008, pp. 159–162

Grinewitschus, V.; Scherer, K.:

**inHaus-2: Ein neues Konzept für die kooperative Entwicklung von Lösungen für das Betreute Wohnen.**

(Kongress Ambient Assisted Living <1, 2008, Berlin>).

In: Ambient Assisted Living. Berlin [u.a.]: VDE-Verl., 2008, pp. 137–141

- Hennig, A.:  
**Feasibility of deeply implanted passive sensor transponders in human bodies.**  
 (European Workshop on RFID Systems and Technologies <4, 2008, Freiburg>).  
 In: RFID SysTech 2008. Berlin [u.a.]: VDE-Verl., 2008, without pagination
- Hennig, A.:  
**RF energy transmission for sensor transponders deeply implanted in human bodies.**  
 (European Microwave Week <38, 2008, Amsterdam>; European Microwave Week <11, 2008, Amsterdam>).  
 In: European Microwave Week 2008. Piscataway, NJ: IEEE, 2008, pp. 424–427
- Klieber, R.; Trieu, H.-K.:  
**Assembly of ASICs for high temperature applications – material characterization and reliability testing.**  
 (Micromechanics Europe Workshop <19, 2008, Aachen>).  
 In: MME 2008. Aachen: Technische Hochschule, 2008, pp. 393–396
- Koch, C.; Görtz, M.; Trieu, H.-K.; Mokwa, W.:  
**The EPI-RET-3 wireless intraocular retina implant system: technical features – fabrication and assembly techniques.**  
 (ARVO Annual Meeting <2008, Fort Lauderdale, Fla.>).  
 In: ARVO 2008 Annual Meeting. Rockville, Md.: ARVO Office, 2008, p.154
- Koch, C.; Fassbender, H.; Nolten, U.; Görtz, M.; Mokwa, W.:  
**Fabrication and assembly techniques for a 3rd generation wireless epiretinal prosthesis.**  
 (Micromechanics Europe Workshop <19, 2008, Aachen>).  
 In: MME 2008. Aachen: Technische Hochschule, 2008, pp. 365–368
- Koch, C.; Görtz, M.; Trieu, H.-K.; Mokwa, W.:  
**First results of a study on a completely implanted retinal prosthesis in blind humans.**  
 (Conference on Sensors <7, 2008, Lecce>).  
 In: IEEE Sensors 2008. Piscataway, NJ: IEEE, 2008, pp. 1237–1240
- Krisch, I.; Görtz, M.; Hosticka, B. J.:  
**A wireless epiretinal prosthesis.**  
 (ARVO Annual Meeting <2008, Fort Lauderdale, Fla.>).  
 In: ARVO 2008 Annual Meeting. Rockville, Md.: ARVO Office, 2008, p. 230
- Meyer, F.; VomBögel, G.; Ressel, C.; Dimitrov, T.:  
**inHaus2 – Intelligent construction site logistics.**  
 (European Workshop on RFID Systems and Technologies <4, 2008, Freiburg>).  
 In: RFID SysTech 2008. Berlin [u.a.]: VDE-Verl., 2008, without pagination
- Mokwa, W.; Görtz, M.; Koch, C.; Krisch, I.; Trieu, H.-K.; Walter, P.:  
**Intraocular epiretinal prosthesis to restore vision in blind humans.**  
 (Annual International Conference of the IEEE Engineering in Medicine and Biology Society <30, 2008, Vancouver>).  
 In: Proceedings of the 30<sup>th</sup> Annual International Conference of the IEEE Engineering in Medicine and Biology Society. Piscataway, NJ: IEEE Operation Center, 2008, pp. 5790–5793
- Nachrodt, D.; Paschen, U.; ten Have, A.; Vogt, H.:  
**Ti/Ni(80%)Cr(20%) thin-film resistor with a nearly zero temperature coefficient of resistance for integration in a standard CMOS process.**  
 In: IEEE Electron device letters 29 (2008) 3, pp. 212–214
- Naroska, E.; Ressel, C.; Dimitrov, T.:  
**Automatisches Warnsystem zur frühzeitigen Erkennung fehlender Aktivität in der häuslichen Umgebung.**  
 (Kongress Ambient Assisted Living <1, 2008, Berlin>).  
 In: Ambient Assisted Living. Berlin [u.a.]: VDE-Verl., 2008, pp. 243–247
- Naroska, E.; Grinewitschus, V.; Stockmanns, G.; Scherer, K.:  
**inHaus: eine Forschungs-, Entwicklungs- und Testplattform für intelligente Umgebungen.**  
 In: Inno 13 (2008) 41, p. 5  
[http://www.ivam.de/files/mitteilungsdateien/1321\\_inno41\\_for\\_web.pdf](http://www.ivam.de/files/mitteilungsdateien/1321_inno41_for_web.pdf)
- Pieczynski, J.; Doncov, I.:  
**Modeling of high-voltage NMOS transistors using extended BSIM3 model.**  
 (International Conference Mixed Design of Integrated Circuits and Systems <15, 2008, Poznan>).  
 In: Proceedings of the 15<sup>th</sup> International Conference Mixed Design of Integrated Circuits and Systems. Łódź, 2008, pp. 75–80

Sommer, S. P.; Paschen, U.; Vogt, H.:

**Positive charge trapping induced by plasma charging damage in NMOS transistors.**

(ESSDERC <38, 2008, Edinburgh>).

In: ESSDERC ESSCIRC 2008. Bristol [u.a.]: IOP Publ. 2008, Fringe session P28, without pagination

Uhrmann, T.; Dimopoulos, T.; Brückl, H.; Lazarov, V. K.;

Kohn, A.; Paschen, U.; Weyers, S.; Bar, L.; Rührig, M.:

**Characterization of embedded MgO/ferromagnet contacts for spin injection in silicon.**

In: Journal of applied physics 103 (2008) 6, pp. 063709-1–063709-5

Urban, U.; Fassbender, H.; Görtz, M.; Trieu, H.-K.;

Steinseifer, U.; Schmitz-Rode, T.; Schnakenberg, U.:

**CHF-Monitoring – Bewertung von zwei alternativen Implantatkonzepten.**

(Kongress Ambient Assisted Living <1, 2008, Berlin>).

In: Ambient Assisted Living. Berlin [u.a.]: VDE-Verl., 2008, pp. 363–365

Vogt, H.:

**Films – Ein Programm zur Simulation von AR-Schichten.**

(Thüringer Kolloquium Dünne Schichten in der Optik <1, 2008, Jena>).

In: 4. Thüringer Grenz- und Oberflächentage & 1. Thüringer Kolloquium „Dünne Schichten in der Optik“. Jena: INNO-VENT e.V., 2008, pp. 282–283

VomBögel, G.:

**Grundlagen der RFID-Technologie und anwendungsspezifische Eigenschaften im Bauwesen.**

(Kongress RFID im Bau <2008, Berlin>).

In: RFID im Bau. Dresden: ARGE RFID, 2008, without pagination

VomBögel, G.:

**Moderne Baustellenlogistik durch Einsatz neuer Informations- und Kommunikations-Technologien.**

(Fachtagung Praxis Transportbeton <2008, Magdeburg>).

In: Beton 58 (2008) 9, Sonderteil Fachtagung, p. 9

Wang, J.; Feldengut, T.; Kolnsberg, S.; Kokozinski, R.:

**A concept for the analysis of cross sensitivities in modern RFID systems.**

(European Workshop on RFID Systems and Technologies <4, 2008, Freiburg>).

In: RFID SysTech 2008. Berlin [u.a.]: VDE-Verl., 2008, without pagination

## 2. Oral Presentations

Grinewitschus, V.:

**Intelligente Umgebungen: Anwendungen und Einsatzmöglichkeiten für mobile Roboter.**

Fraunhofer IPA, 2. Technologieforum, Stuttgart, November 14, 2008

Grinewitschus, V.:

**Wired and smart: embedded internet systems.**

Amigo Symposium, Eindhoven, February 28, 2008

Naroska, E.:

**Sicher Wohnen durch smarte Haustechnik – Chancen und Risiken des Bewohner-Monitorings.**

REHACARE Kongress, Düsseldorf, October 17, 2008

Scherer, K.:

**Making smart environments real.**

Rostocker Assistentztage <RASTA>, February 21, 2008

Scherer, K.:

**Der schlaue Raum als Freund und Helfer: Smart Home & Building – aktuelle Trends innovativer Technik in Räumen und Gebäuden.**

REHACARE Kongress, Düsseldorf, October 17, 2008

Scherer, K.:

**Smart Building – Mehrwert durch Breitbandkommunikation.**

BREKO Bundesverband Breitbandkommunikation Jahrestagung „Ein Netz für die Zukunft“, Berlin, November 13, 2008

Scherer, K.:

**Wie helfen Industrie und Forschung das effiziente Hotel zu bauen?**

ITB Hospitality Day, Berlin, March 6, 2008

Schrey, O.:

**Custom CMOS image sensors, architecture and design.**

Image Sensors Europe, London, March 19, 2008

Stevens, T.:

**Integrierte Haussteuerung: Komfort in den eigenen vier Wänden durch ganzheitliche Steuerkonzepte für Hausgeräte und Hausinfrastruktur.**

Fraunhofer-ISST Veranstaltung „Service-Wohnen zur Mieterbindung: Lösungskonzepte für die Wohnungswirtschaft und neue Potenziale für Dienstleister“, Dortmund, March 11, 2008

Stockmanns, G.:  
**Intelligent analysis of monitoring signals.**  
21<sup>st</sup> Annual Congress European Society of Intensive Care  
Medicine, Lissabon, August 29, 2008

Stockmanns, G.:  
**Signal analysis in neuromonitoring.**  
21<sup>st</sup> Annual Congress European Society of Intensive Care  
Medicine, Lissabon, August 29, 2008

Stockmanns, G.:  
**Die Zukunft des Wohnens für Jung und Alt – Ambient  
Intelligence und aktuelle Forschungstrends am Beispiel  
von inHaus2.**  
REHACARE Kongress, Düsseldorf, October 17, 2008

Thoß, S.:  
**Neuartiges Ausleseverfahren für induktive Näherungs-  
sensoren auf Basis von Sigma-Delta Modulation.**  
10. Workshop „Integrierte Analogschaltungen“, Berlin,  
March 10, 2008

VomBögel, G.:  
**RFID im Bauwesen: Evaluierung der RFID-Technologie  
zur Optimierung von logistischen Prozessen an ver-  
schiedenen Bauprodukten.**  
Euro-ID, Köln, May 15, 2008

VomBögel, G.:  
**RFID und Sensornetzwerke für die dezentrale Steue-  
rung von Materialfluss und Kommissionierung.**  
RFID-Praxistag Logistik, IHK, Dortmund, June 19, 2008

### 3. Patents

#### 3.1 Granted Patents

Jung, P.; Sappok, S.:  
**Vorrichtung und Verfahren zum Abwärtsmischen eines  
Eingangssignals in ein Ausgangssignal.**  
February 29, 2008  
JP 4087850

Krisch, I.; Brockherde, W.; Hosticka, B. J.:  
**Video endoscopy device.**  
March 6, 2008  
JP 506478

Müller, H.-C.; Greifendorf, D.; Lörcks, M.; Jansen, A.;  
Kokozinski, R.; Holzapfel, M.:  
**Datenübertragung zwischen mehreren Sendern und  
einem Empfänger.**  
November 19, 2008  
EP 1 835 664 B1

Nehrig, O.:  
**Apparatus and method for reading out a differential  
capacity with a first and second partial capacity.**  
April 8, 2008  
US 7,356,423 B2

#### 3.2 Laid Open Patent Documents

Boom, T. van den; Hosticka, B.-J.; Trieu, H.-K.:  
**Vorrichtung und Verfahren zum geregelten Transport  
mikrofluidischer Proben.**  
October 30, 2008  
DE 10 2007 018752 A1

Fritsch, D.; VomBögel, G.; Ledermann, T.; Wolfelschneider, H.:  
**Concept for determining the position of a passive trans-  
ponder in a radio system.**  
May 2, 2008  
PCT/EP2007/009145

Fritsch, D.; VomBögel, G.; Ledermann, T.; Wolfelschneider, H.:  
**Konzept zur Positionsbestimmung eines passiven Trans-  
ponders in einem Funksystem.**  
April 30, 2008  
DE 10 2006 049 862 A1

Grabmaier, A.; Boom, T. van den; Dahmen, U.; Dirsch, O.;  
Stockmanns, G.; Viga, R.; Balzani, D.; Brands, D.:  
**Vorrichtung und Verfahren zum Erfassen eines druck-  
abhängigen Parameters.**  
December 24, 2008  
DE 10 2007 0384402 A1

Krisch, I.; Brockherde, W.; Hosticka, B. J.:  
**Videoendoskopievorrichtung.**  
March 6, 2008  
JP 2008-506478

Trieu, H.-K.; Slotkowski, J.; Klieber, R.; Van Heest, J. C. M.;  
Koch, K.; Rutjes, F. P. J. T.; Nieuwland, P.J.; Wiebe, P.:  
**Chip holder, fluidic system and chip holder system.**  
May 2, 2008  
PCT/EP2006/010299

Trieu, H.-K.; Wiebe, P.; Klieber, R.:  
**Device and method for checking and monitoring the pressure in pressure pipes and/or conduits.**  
July 17, 2008  
PCT/EP2006/012513

Trieu, H.-K.; Schelle, B.; Slotkowski, J.; Ünlübayir, S.:  
**Elektrische Drucksensorvorrichtung.**  
July 16, 2008  
EP 1 944 597 A1

Vogt, H.; Russ, M.:  
**Bolometer and method for producing a bolometer.**  
March 13, 2008  
PCT/EP2006/008790

## 4. Theses

### 4.1 Dissertations

Bechen, B.:  
**Systematischer Entwurf analoger Low-power Schaltungen in CMOS anhand einer kapazitiven Sensorauslese.**  
In: Stuttgart: Fraunhofer IRB Verl., 2008  
Zugl.: Duisburg-Essen, Campus Duisburg Univ., Diss., 2008  
ISBN 978-3-8167-7579-9

### 4.2 Diploma Theses

Eiker, A.:  
**Analyse und Optimierung der Genauigkeit eines optoelektronischen Testsystems für die Charakterisierung von rauscharmen CMOS-Bildsensoren**  
Krefeld-Mönchengladbach, Campus Krefeld, Hochsch.,  
Dipl.-Arb., 2008

Eschke, J.:  
**Entwurf, Aufbau und Verifikation von modularen Leistungsverstärkern für einen RFID-Reader im UHF ISM-Band.**  
Dortmund, Fachhochsch., Dipl.-Arb., 2008

Faber, D.:  
**Entwurf und Optimierung eines Demodulators für ein passives UHF Transponder Front-End.**  
Duisburg-Essen, Campus Duisburg, Univ., Dipl.-Arb., 2008

Sänger, S.:  
**Optimierung der Trench-Isolation für einen SOI-CMOS-Prozess.**  
Darmstadt, Techn. Univ., Dipl.-Arb., 2008

Wösten, S.:  
**Analyse, Aufbau und Implementierung eines aktiven low-power Testtransponders im europäischen UHF-Band nach EPC Class 1 Gen 2-Standard (ISO 18000-6c).**  
Osnabrück, Fachhochsch., Dipl.-Arb., 2008

## 4.3 Master Theses

Emre, E.:  
**Camera system for an infrared sensitive microbolometer array.**  
Duisburg-Essen, Campus Duisburg, Univ., Master Thesis, 2008

Lehmann, B.:  
**Entwicklung eines optimierten Protokollstacks für HF-Sensortranspondersysteme in medizinischen Anwendungen.**  
Wuppertal, Univ., Master Thesis, 2008

## 4.4 Bachelor Theses

Beier, T.:  
**Optimierung von Reinigungsprozessen im CMP Bereich.**  
Düsseldorf, Fachhochsch., Bachelor Thesis, 2008

Doncov, I.:  
**BSIM3 Modellparameterextraktion eines 1,2 µm Prozesses mit Drucksensor- und Hochvoltoptionen mit Hilfe des IC-CAP Softwarepakets.**  
Düsseldorf, Fachhochsch., Bachelor Thesis, 2008

Feberwee, N.:  
**Charakterisierung von Packagingmaterialien für Hochtemperatur-Halbleiterbauelemente.**  
Düsseldorf, Fachhochsch., Bachelor Thesis, 2008

Gawlik, C.:  
**Parasitäre Feldeffekttransistoren in einer 0.35 µm CMOS Technologie.**  
Düsseldorf, Fachhochsch., Bachelor Thesis, 2008

Gerbecks, J.:

**Konzeption und Implementation einer mobilen, Senioren unterstützenden Infrastruktur für die häusliche Pflege.**

Duisburg-Essen, Campus Essen, Univ., Bachelor Thesis, 2008

Ghoshdastider, U.:

**Implementation of an application specific digital interface to control a high frame rate image array sensor in a 0,35  $\mu\text{m}$  CMOS technology.**

Duisburg-Essen, Campus Duisburg, Univ., Bachelor Thesis, 2008

Gorski, D.:

**Entwicklung einer Plattform zur Evaluierung von Protokollstacks für HF Sensortranspondersysteme.**

Duisburg-Essen, Campus Duisburg, Univ., Bachelor Thesis, 2008

Hanhan, K.:

**Analysis and enhancement of a force sensor for a decentralized system architecture.**

Duisburg-Essen, Campus Duisburg, Univ., Bachelor Thesis, 2008

Haverkamp, S.:

**Development of a passive RFID sensor transponder for humidity measurement.**

Duisburg-Essen, Campus Duisburg, Univ., Bachelor Thesis, 2008

Huypen, T.:

**Entwicklung einer generischen Regelsprache für ambiente Systeme.**

Venlo, Hogeschool, Bachelor-Thesis, 2008

Jawo, M.-O.:

**Development of a 3D-Laser scanner to acquire room geometry based on the Ethernut 3 platform and the generation of 3D models deploying object-oriented programming languages to simplify navigation in home automation.**

Duisburg-Essen, Campus Duisburg, Univ., Bachelor Thesis, 2008

Lessner, N.:

**Entwicklung eines Beschleunigungssensormoduls zur Verbesserung der Ortsauflösung von Lokalisierungssystemen.**

Duisburg-Essen, Campus Duisburg, Univ., Bachelor Thesis, 2008

Mertens, M.:

**Entwicklung eines automatisierten Testsystems für die Charakterisierung eines 0.35  $\mu\text{m}$  CMOS-Prozesses auf Wafer Ebene.**

Düsseldorf, Fachhochsch., Bachelor Thesis, 2008

Nguyen, T.:

**Installation und Charakterisierung eines Trenchmoduls in einer 0,35  $\mu\text{m}$  SOI CMOS Technologie.**

Düsseldorf, Fachhochsch., Bachelor Thesis, 2008

Süss, A.:

**Full-Custom-Design eines skalierbaren, Self-timed, Low-Power SRAMs für ein Generatorsystem in einer Submicron-Technologie.**

Düsseldorf, Fachhochsch., Bachelor Thesis, 2008

Waoh, J.:

**Implementation of a transponder functionality of a sensor transponder with the function for humidity and temperature measurement.**

Duisburg-Essen, Campus Duisburg, Univ., Bachelor Thesis, 2008

#### 4.5 Project Theses

Brockners, C.:

**Aufbau eines ultrasensitiven Rauschmessplatzes zur Charakterisierung des Rauschverhaltens von amorphen Widerständen und SOI-Zehner-Dioden.**

Duisburg-Essen, Campus Duisburg, Univ., Project Thesis, 2008

Gawlik, C.:

**Charakterisierung von Prozessschwankungen.**

Düsseldorf, Fachhochsch., Project Thesis, 2008

Kisters, C.:

**Entwicklung einer Benutzerschnittstelle für eine Simulationsumgebung der Ambienten Systeme.**

Duisburg-Essen, Campus Duisburg, Univ., Project Thesis, 2008

Ragunathan, D.; Fettane, A.:

**Untersuchung der Anbindungs- und Kommunikationsmöglichkeit von CAN Bus an einem drahtlosen Sensor-knoten (ZigBee).**

Dortmund, Fachhochsch., Project Thesis, 2008

Süss, A.:  
**Chipentwicklung und Layout für ein Generatorsystem zur skalierbaren Erzeugung von Submicron-Speicherchips.**  
Düsseldorf, Fachhochsch., Project Thesis, 2008

Zhou, H.:  
**Entwurf und Optimierung eines UHF Gleichrichters für passive Transponder.**  
Duisburg-Essen, Campus Duisburg, Univ., Project Thesis, 2008

## 5. Product Information Sheets

**Drahtloses Messen – Beispiel Fahrrad-Computer**  
IMS-Duisburg, 2008

**FlexRay™ Protocol  
Conformance Test System**  
IMS-Duisburg, 2008

**Passive UHF Transponder with Integrated Sensors**  
IMS-Duisburg, 2008

**Passiver UHF Transponder mit integriertem Temperatursensor**  
IMS-Duisburg, 2008

**Sensor Network  
Wireless Displays**  
IMS-Duisburg, 2008

**Sensornetzwerk  
drahtlose Displays**  
IMS-Duisburg, 2008

# Chronicle 2008



## New Trends in CMOS Imaging at Fraunhofer IMS

What will be the design of imager chips in the future? Which technique are sensors and cameras going to have? The 4<sup>th</sup> Fraunhofer IMS Workshop on CMOS Imaging (6<sup>th</sup> and 7<sup>th</sup> May, 2008) tried to give ideas about it and worked under the motto "Catching the Photons". Reknown speakers from European industry and specialists from universities talked about state of the art and possible developments of technology, sensors and imagers. One of the new topics introduced this time were imagers for Life Sciences which is an interesting new branch in the field of imaging. Again the programme with speakers like e.g. Johannes Solhusvik/Micron Norway and Koichi Mizobuchi/Texas Instruments succeeded in being interesting to the experts in Europe and

also Japan, Israel and U.S.A. Together with the preceding workshops in the last years Fraunhofer IMS established a well known forum on topics all around design, application which is taking place every two years. Very special this time was the location at the Tectrum in Duisburg which was designed by sketches of Sir Norman Foster. Because of its interesting architecture and also because of the great support at this place through the sponsors Helion, Aspect System, and ELMOS the participants were invited to participate discussion in a very special surrounding. All guests were delighted and promised to come back at the occasion of the next workshop!

For more information please have a look at our programm in the internet under [www.ims.fraunhofer.de](http://www.ims.fraunhofer.de) in the category events.



4th Fraunhofer IMS Workshop  
**CMOS Imaging**  
Catching the Photons

## Access to the future

November 5, 2008 saw the inauguration of an unusual building: inHaus2. For about one-and-a-half years, this building has been the subject of research and development concerning intelligent construction, new materials and energy-saving systems. But from now on, visitors will also be able to witness future-oriented, constantly changing and flexible room concepts being tested – for hotels, offices and nursing homes.

The cranes have been dismantled and the muddy paths have given way to an attractive park: inHaus2 is finished. "At least finished as far as construction is concerned," specifies Klaus Scherer of the Fraunhofer Institute for Microelectronic Circuits and Systems IMS, who heads the inHaus innovation center in Duisburg. "In terms of research and development, on the other hand, we are far from reaching the end. All the exciting projects planned with our application partners are now about to begin, and the labs, as we call them, have been or are being set up."

One of these is the Health and Care Lab, where new models are being developed which help to look after people in need of care, and the organization of care facilities is being made easier. Technical solutions can provide greater safety for elderly, disabled or sick people in need of care, without restricting their independence. In the next-generation nursing home with its networked room systems, cases of emergency can be automatically recognized and staff can react quickly. "But the idea goes much further than that, with sensors in each room automatically delivering electronic data to support the care documentation process. This would help to save an enormous amount of time and money, which in turn

would benefit the patients," explains Wolfgang Meyer of ambient assisted living GmbH. In order to find out how this idea would be received by the patients themselves and which measures would most effectively support the nursing staff, studies are being carried out at regular intervals with the help of everyone involved. On the occasion of the opening celebrations, the Fraunhofer Institute for Industrial Engineering IAO presented its showcase "Pflege 2020" (Care 2020), introducing a living environment for elderly people that enables them to remain active and independent, and ensures their safety.

The other two research areas – NextHotel and OfficeLab – are being coordinated by the IAO and implemented in close collaboration with Lindner Hotels and T-Systems. In order to ensure that the developments actually take users' needs into account, test specialists from the inHaus application partners regularly assess how practicable the concepts are in everyday life and how they can be marketed.

"Innovations concerning buildings have not developed anywhere near as dynamically as those in other sectors over the past decades, if we exclude all the smart glass facades. The great bursts of innovation we have experienced in information technology or biotechnology, for example, have not yet taken place in this domain. But that is about to change in a big way. The energy crisis, global warming and, above all, new requirements in terms of flexible use will induce a huge innovation competition, not only in Germany but also on a global scale. Everyone involved faces the same challenge – to realize ecologically, economically and socially sustainable buildings for living and working in," says Prof. Dr. Hans-Jörg Bullinger, President of the Fraunhofer-Gesellschaft.



The plans and ideas of the nine participating Fraunhofer Institutes and their approximately 60 industrial partners cover a wide diversity of subjects. What unites them all on this research platform is the goal of creating economical and environmentally friendly commercial properties – from construction and planning to materials research, running of the buildings, and various usages. “The visionary concepts being implemented here by the Fraunhofer researchers and their industrial partners will significantly change construction products and processes and the usage of buildings,” says Prof. Klaus Sedlbauer, director of the Fraunhofer Institute for Building Physics IBP. “This future-oriented model provides a great opportunity to positively and directly influence and improve people’s living environments.”

The state of North Rhine-Westphalia is already reaping the benefits: “The knowledge gained from the inHaus2 project with regard to lowering energy consumption in office buildings has been incorporated in the construction of the new building of the State Office for Data Processing and Statistics (LDS NRW). This means that inHaus2 has already entered the second chapter of its success story,” says innovation minister Professor Andreas Pinkwart.

A research program worth 27 million euros is scheduled to run until the end of 2011. Three-quarters of the approximately 9 million euros of investment funds required for the inHaus2 research facility is being provided by the EU and the state of North Rhine-Westphalia. The federal government, the city of Duisburg and the Fraunhofer-Gesellschaft are also supporting the project. The industrial partners and a range of public funding projects will each cover 50 percent of the costs for the inHaus2 research program. The joint activities are starting to pay off, as demonstrated

by the first results: These include all the developed and tested components revolving around the intelligent construction site, ranging from electronic delivery notes and RFID goods-reading gates for delivery trucks to a construction-site portal and a digital building record (Digitale Gebäudeakte). The partners HOCHTIEF AG and T-Systems are already putting these results into practice at the next major building site: the Elbphilharmonie concert building in Hamburg.

#### Participating Fraunhofer Institutes for

- Microelectronic Circuits and Systems IMS
- Building Physics IBP
- Software und Systems Engineering ISST
- Digital Media Technology IDMT
- Solar Energy Systems ISE
- Industrial Engineering IAO
- Manufacturing Engineering and Automation IPA
- Environmental, Safety and Energy Technology UMSICHT
- Material Flow and Logistics IML

#### Industrial partners (status: 11/2008) System partners

- BASF SE
- Henkel KGaA
- HOCHTIEF AG
- Josef Gartner GmbH
- OSRAM LIGHT CONSULTING GmbH
- SAINT-GOBAIN ISOVER G+H AG
- T-Systems
- Xella International GmbH

#### Component partners

- AppliedSensor GmbH
- Bene Deutschland GmbH
- Berker GmbH & Co. KG
- caverion GmbH
- CENO Membrane Technology GmbH
- curveLED GmbH
- Deutsches Kupferinstitut Berufsverband



- DORMA GmbH + Co. KG
- e:cue GmbH & Co. KG
- EBV Elektronik GmbH & Co. KG
- Elabo GmbH
- ESYLUX GmbH
- Gesellschaft für audiovisuelle Erlebnisse mbH
- HAFI Beschläge GmbH
- Hager Tehalit Vertriebs GmbH
- HANSA Metallwerke AG
- Intermundien GmbH
- KERMI GmbH
- Kieback&Peter GmbH & Co KG
- Klafs GmbH & Co. KG
- KRANTZ KOMPONENTEN caverion GmbH
- Lancom Systems GmbH
- LightLife
- Mauser Einrichtungssysteme GmbH&KoKG
- Menerga Apparatebau GmbH
- MLR System GmbH
- OBO BETTERMANN GmbH & Co. KG
- Odenwald OWA Faserplattenwerk GmbH
- Planet Digital GmbH & Co KG
- protel hotelsoftware GmbH (via Fraunhofer IAO)
- Ratioplast-Optoelectronics GmbH
- scemtec automation GmbH
- Schindler Lifts. Ltd.
- UNIPOR-Ziegel Marketing GmbH
- Vaillant GmbH
- VESTAMATIC GmbH
- Viega GmbH & Co. KG
- Villeroy & Boch AG
- Wilo AG
- WINI Büromöbel Georg Schmidt GmbH & Co KG
- Wirtschaftsbetriebe Duisburg - AöR
- Wolf Heiztechnik GmbH
- Zent-Frenger Gesellschaft für Gebäudetechnik mbH

#### **Application partners**

- ambient assisted living GmbH
- Duisburger Versorgungs- und Verkehrsgesellschaft mbH
- DüsseldorfCongress Veranstaltungsgesellschaft mbH
- Lindner Hotels AG

#### **Sponsors**

ad notam GmbH, Baulmann Leuchten, bimos-Sitztechnik, BRUCK GmbH & Co.KG, Crestron Germany GmbH, Deckendesign Redmer, Dometic GmbH, Drumm & Partner, Facet, FBF bed&more, FEIG ELECTRONIC GmbH, Freudenberg Bausysteme KG, Future-Shape GmbH, Geohaus Meßbild Engineering & Control GmbH, GP Acoustics GmbH, inHaus GmbH, Markus-Diedenhofen, Media Agentur Kepnik, nora systems GmbH, Rosink GmbH, Shure Distribution GmbH, Starmix, Stockheim GmbH & Co. KG, Stockmanns GmbH & Co. KG, t+t netcom, TOMBUSCH & BRUMANN, Vorwerk & Co. Teppichwerke GmbH & Co. KG

## Joseph von Fraunhofer Prize 2008 for wireless vision implant

About 30 million people around the world have grown legally blind due to retinal diseases. The EPI-RET project has sought for a technical solution for the past twelve years to help these patients. This work has resulted in a unique system – a fully implantable visual prosthesis.

For twelve years, experts from different disciplines in the fields of microelectronics, neurophysics, information engineering, computer science, materials science and medicine have been working to develop a visual prosthetic device for patients who have lost their sight through diseases of the retina. In September 2007, their effort was rewarded. In a clinical study including six patients, the team was able to demonstrate not only that a completely implantable vision prosthesis is technically feasible and proven functioning, but also that it enables patients to perceive visual images. "For normally sighted people that may not seem much, but for the blind, it is a major step," comments Dr. Hoc Khiem Trieu from the Fraunhofer Institute for Microelectronic Circuits and Systems IMS in Duisburg. "After years of blindness, the patients were able to see spots of light or geometric patterns, depending on how the nerve cells were stimulated." Dr. Hoc Khiem Trieu has been involved from the outset of this project, which was funded by the German Ministry of Education and Research. Together with Dr. Ingo Krisch and Dipl.-Ing. Michael Görtz he translated the specifications given by the medical experts and material scientists into an implant and chip design. The scientists receive the Joseph von Fraunhofer Prize 2008 for their work.

"A milestone was reached when the prosthetic system finally operated wirelessly and remotely controlled," explains Dr. Ingo Krisch. "A great deal of detailed work was necessary before the implant could be activated without any external cable connections." "The designs became smaller and smaller, the materials more flexible, more robust and higher in performance, so that the implant now fits comfortably in the eye," reports Michael Görtz. The system benefits from a particular disease pattern, and it uses a specific operating principle to restore sight: Suffering from retinitis pigmentosa, the light sensitive cells are destroyed, but the connection of the nerve cells to the brain remains intact. The scientists have bypassed the defects of the retina by means of a visual prosthesis. The complete system comprises the implant and an external transmitter integrated in a spectacle-frame. The implant system converts the image patterns into interpretable stimulation signals. Data and energy are transferred to the implant by a telemetric link. The nerve cells inside the eye are then stimulated according to the captured images. Those intact cells are innervated by means of three-dimensional stimulation electrodes that rest against the retina like small studs.

EPI-RET GmbH, a spin-off of this project consortium, intends to market the vision prosthesis in about three years' time after a new clinical study of selected patients has been completed with the final product.

*H.-K. Trieu*

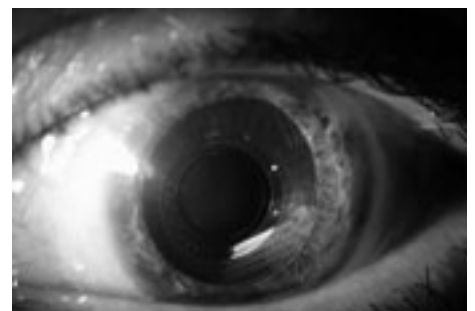

## Trade Fair SENSOR+TEST 2008

Nuremberg, May 6–8, 2008 – Once again the international community in sensor, measuring, and testing technologies got together to present their highlights in transducer and system development. This annual event is one of the most important platforms for Fraunhofer IMS to present its innovative portfolio of micro sensors, transponders, and sensor networks. With 562 exhibitors and 7900 highly qualified trade visitors this trade fair offered a high class forum for technical discussion with engineers in R&D and decision makers.

This year Fraunhofer IMS has set its focus on wireless micro sensors. One object of exposition is a sensor network for application in greenhouses which allows an optimisation of the energy efficiency by monitoring the local distribution of temperature, humidity, and light. Another example of a wireless sensor application is a bicycle computer recording wirelessly the velocity of the vehicle. Apart from agriculture and

consumer electronics wireless micro sensors have found their way into the building sector. Integrated pressure sensor tags in vacuum isolation panels monitor the vacuum quality of the isolating material. A highlight of this year's exhibition is an implantable monitoring system for hypertension. This development unifies all unique selling points of the IMS pressure sensor technology excellently. Apart from the tiny dimension of the integrated pressure sensor – which including packaging fits in a 1 mm catheter – low power consumption and transponder capability are the features of the battery less implant. This device is powered by inductive coupling and the monitoring data are transmitted by using an interference proof in the form of a digital secured procedure to reach an external reading station.

German visitors as well as international ones were attracted by this bundle of innovative solutions for the various application areas. In many cases the visitors have pointed out in advance Fraunhofer IMS as the potential R&D partner for solving their specific problems. Hence, many profound discussions were done with the very well prepared visitors resulting in interesting follow ups. Altogether Fraunhofer IMS is very satisfied with the whole trade fair and is looking forward to the 2009 event.

*Cornelia Metz, Hoc Khiem Trieu*



Figure 1: Dr. Norbert Kordas, a senior engineer from Fraunhofer IMS, presenting the demonstrator of the pressure sensor implant for monitoring of hypertension.

## New Trade Fair Presentation

For the first time Fraunhofer IMS had an exhibition on the international trade fair for optical technologies OPTATEC 2008 from June 17. – 20 in Frankfurt. On a shared booth of the OptecNet Deutschland e.V. the newest research and development results were presented. With more than 500 exhibiting companies from 28 countries, more than 5500 expert visitors, the trade fair for future optical technologies, components, systems and manufacturing confirmed its reputation as an industry meeting place with worldwide participation and standing.

One of the highlights at the IMS booth was the time-of-flight camera demonstrator, a result of the European research project "PREVENT". This camera takes three-dimensional images (2D images plus range image) at real-time video rates. The heart of the camera is the IMS CMOS imager with extremely fast electronic shutter and very low noise. Another important highlight was the announcement of the new 0.35  $\mu\text{m}$  CMOS opto process which enables IMS to fulfil many demands for custom image sensors and other optical devices. Fraunhofer IMS develops and runs this process in its own semiconductor fab in Duisburg.

## inHaus at the Federal Chancellery of Germany

The inHaus Center of Fraunhofer Gesellschaft was invited to present the newest technical inventions in the area of smart living for the Open day 2008 in the Federal Chancellery. The exhibition revealed new developments for energy-efficient living, such as decentralised heating pumps and smart metering.

Decentralised heating pumps help to reduce energy consumption up to 30 per cent. The new device is controlled by a computer programme with an

integrated time schedule so that heat is only generated when and where it is needed. At the Open day, Fraunhofer IMS exhibited and presented different functions of the programme in the Federal Chancellery. One of the main benefits of the device, which was produced by Fraunhofer IMS in cooperation with WILO, is that the heating can now dispense with regulating stop valves since the computer optimises heat distribution automatically. Hence, each individual room can be heated according to personal needs in an energy-efficient way.

The guests were also visibly impressed by Smart Metering, a new device for transparent energy consumption. This gadget, which was developed by Fraunhofer IMS together with RWE and Hager, displays current data about energy consumption on any computer in the house, as well as on PDAs or Smart Phones. All details about the current energy consumption, and that of the last few hours, days and even months are presented in graphics. Thus, house owners know about the amount of energy used for different applications at all times – even in stand-by mode – and can adapt their consumption patterns accordingly. In times of energy-efficient and environmentally friendly living the exhibition of these ground-breaking devices at the Federal Chancellery was a huge success.







# Press Review

## Heißer Draht zum Kuhstall

Die beschaulichen Zellen, in denen der Bauer seine Kühe beim Namen kennt, sind längst vorbei. Heute bleibt in der Milchwirtschaft wenig Zeit für die Tiere. Auch erste Anzeichen einer Krankheit können leicht übersehen werden. Helfen soll ein kleiner Sensor im Farnen der Kuh, der ihren Gesundheitszustand überwacht und rechtzeitig Alarm schlägt. Das System ermittelt den pH-Wert und die Temperatur innerhalb des Farnens. Die Daten werden über eine eingekapselte Mess- und drahtlos an externe Empfangsmodule im Stallband des Tieres übertragen. Ein Sensornetzwerk leitet die Signale an eine zentrale Datenbank weiter. Der Bauer bekommt sofort einen Warnhinweis, wenn ein

Richtwert über oder unterschritten wird. Wissenschaftler vom Fraunhofer-Institut für Mikroelektronische Schaltungen IMS in Duisburg haben das System entwickelt und können es auch an viele weitere Anwendungen in der Land- und Forstwirtschaft anpassen.

Die Entwicklung erfolgte gemeinsam mit niederländischen und deutschen Partnern in einem grenzüberschreitenden Projekt. Kofinanziert wird es durch das EU-Programm INTERREG IIIA der European Rhein-Weald, durch das Ministerium für Wirtschaft, Mittelstand und Energie des Landes Nordrhein-Westfalen sowie durch die Provinz Gelderland.



Ein drahtloses Messsystem ermöglicht eine präzisere Haltung von Rindern. © Fraunhofer IMS/IMS

## Fraunhofer Magazin 04/2008

## Kleine Bauteile mit großer Wirkung

Wird die Produktion einzelner Bauteile wie Sensoren oder Mikrochips abgebrochen, geraten oft ganze Produktionen ins Stocken. Hamsterkäufe verzögern das Problem lediglich. Forscher am Fraunhofer IMS können die Herstellung übernehmen und das Produkt sogar optimieren.

Ein kleiner Aufkleber mit dem Wörtchen »Neu« prangt am Lieblingsshampoo und kündigt an, dass es mit der bisherigen Rezeptur vorbei ist. Also entweder daran gewöhnen oder ein neues Produkt suchen. Was im privaten Bereich lediglich lästig ist, kann sich für Firmen als gefährlicher Schlag entpuppen: Nimmt ein Zulieferer einen Sensor oder ein Halbleiterbauteil aus seinem Programm, kann dies gesamte Produktionslinien gefährden. Denn viele Geräte sind genau auf diese Bauteile angepasst und können nicht ohne weiteres mit Ersatzchips oder Ersatzsensoren bestückt werden.

wenden platziert und der Markt leer gekauft, doch solche Hamsterkäufe schaffen meist nur eine kurze Verschaffepause, bevor das Problem erneut auftaucht.

Kundenspezifische Lösungen auch in kleinen Stückzahlen.

Was tun? Das Fraunhofer-Institut für Mikroelektronische Schaltungen und Systeme IMS aus Duisburg kennt diese Schwierigkeiten aus einer Vielzahl von Kundenanfragen – und stellt Bauteile und Sensoren im Kund-

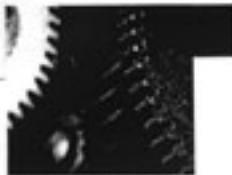

Die »Kittchen« im Gehäuse – kleine Bauteile wie Sensoren können nicht ohne weiteres ausgetauscht werden. Foto: jenslo.de / Jürgen Acker

## Kostspielige Folgen in sensiblen Bereichen

Ein Beispiel ist ein sicherheitsrelevantes Teil der Radaufhängung eines Flugzeugs nicht mehr lieferbar, muss unter Umständen das gesamte System neu zugelassen werden – ein teures Unterfangen, das Firmen enorme Mengen an Geld und Zeit kosten kann. Ähnlich ist es bei medizinischen Geräten, Helikopter-»Last-Order«-Bestellungen»



## VµE Nachrichten Dezember 2008

### Empfindsame Helfer

Die drahtlose Energie- und Informationsübertragung eröffnet neue Möglichkeiten in medizinischen oder industriellen Anwendungen. Bei dieser Technik, die bereits bei medizinischen Implantaten oder bei der Messung von Federdruck in ROW zum Einsatz kommt, erfassen sogenannte intelligente Sensoren zunächst physikalische Größen wie Druck, Temperatur oder Feuchtigkeit. Die Messwerte werden dann von einem mikroelektronischen Sensor-Transponder erfasst, umgewandelt und an ein externes Lesegerät gesendet.



Klein aber oho: der Sensor-Transponder aus dem Fraunhofer IMS. Foto: Fraunhofer IMS

Ein wichtiges Anwendungsfeld der neuen Sensor-Transponder ist beispielsweise die Überwachung von Körperdaten. Lieferungen von Medikamenten oder Lebensmittel werden mit Temperatur-Sensor-Transpondern, UDRN, Container und Lager werden mit Lesegeräten ausgestattet. Wird beispielsweise an einem der Produkte die zulässige Höchsttemperatur überschritten, kann dies vermerkt und darauf reagiert werden.

## VµE Nachrichten Dezember 2008

## Nicht unter Druck setzen lassen!

Wer diesen Ratsschlag befolgt, fühlt sich wohl in seiner Haut. Doch was, wenn der Druck von innen kommt? Erhöhter Blutdruck, Augeninnendruck oder Hirndruck, der nicht rechtzeitig erkannt wird, kann unsere Gesundheit erheblich gefährden. Umso wichtiger ist es für Risikopatienten, ihre Werte immer im Blick zu haben. Ganz einfach funktioniert dies mit einem neuen Implantat aus dem Fraunhofer IMS.

Die miniaturisierten, medizinischen Implantate erleichtern den behandelnden Ärzten den Arbeitsalltag und ermöglichen den Patienten eine optimale Kontrolle ihrer Vitalfunktionen. Die kleinen drahtlosen Helfer besitzen integrierte kapazitive Druck- und Temperatursensoren und erfassen die physiologischen Parameter an ihrem jeweiligen

gespeichert. So kann der Arzt die Daten seines Patienten beim nächsten Praxisbesuch auslesen und die weitere Behandlung anpassen. Die Erfassung von Sensordaten aus dem menschlichen Körper stellt hohe Anforderungen an medizinische Implantate.

### Vielfältige Implantatlösungen

Das Fraunhofer-Institut für Mikroelektronische Schaltungen und Systeme IMS in Duisburg hat sich der Lösung dieser anspruchsvollen Aufgabe angenommen und entwickelt vielfältige Implantatlösungen. Diese basieren meist auf batterielosen Transpondersystemen mit kapazitiven On-Chip-Drucksensoren und integrierten Auswertungen, welche die Messwerte mittels elektromagnetischer Kopplung aus dem Körperinneren übertragen. Die geringe Größe sowie das energieeffiziente Funktionsprinzip gewährleisten eine kontinuierliche und problemlose Kontrolle jeglicher Druckparameter im menschlichen Körper.



Implantationsort. Über eine Antennenspitze, die dem Implantat gleichzeitig zur Energiegewinnung dient, werden die Messwerte zu einem externen Lesegerät übertragen und

Die Redewendung »etwas aber tot« trifft hier auf den Punkt: Miniaturisierte medizinische Implantate erleichtern den behandelnden Ärzten in Zukunft den Arbeitsalltag und ermöglichen den Patienten eine optimale Kontrolle ihrer Vitalfunktionen. Foto: Fraunhofer IMS

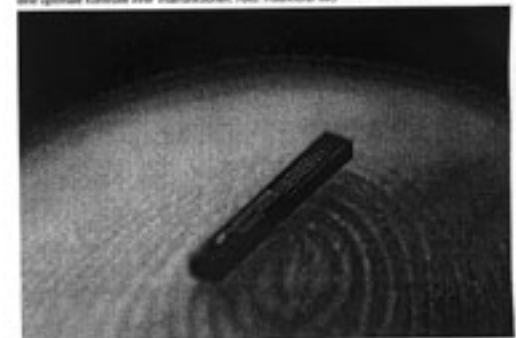

## VµE Nachrichten Juni 2008

### Auf den Punkt getroffen

dann die Position dieses Punktes und berechnet auf Grundlage der Lichtwellenlänge die Distanz zum Objekt.

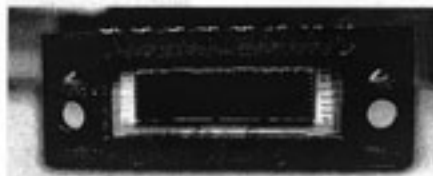

Nichtes Planlos: der Triangulations-Sensor aus dem Fraunhofer IMS. Foto: Fraunhofer IMS

Präzision ist in Produktionsprozessen das A und O. Kleine Ungenauigkeiten bei der Vermessung der zu produzierenden Objekte führt zu mangelhaften Ergebnissen und kann im schlimmsten Fall die gesamte Produktionsreihe unbrauchbar machen. Um ein punktgenaues Abbild des zu produzierenden Objekts zu erhalten, setzt die Industrie optische Sensoren ein, die in der Lasertechnologie auf Basis des Triangulationsprinzips arbeiten. Trifft der Laserstrahl auf das zu messende Objekt, wird er dort als kleiner Punkt reflektiert. Dieser Punkt wird über ein Objektiv auf einem Positionssensor (CMOS-Zellenarray) abgebildet. Der Empfänger des Sensors erfasst

Auf diese Weise tastet der Laserstrahl Oberflächen, wie z. B. Metall, Holz, Gummi und sogar hochreflektierende Materialien wie Glas, Stahl oder Silizium-Wafer ab und ermittelt dabei alle erforderlichen Prozess- und Qualitätsparameter: Ungenauigkeiten wie Vibrationen, Auslenkungen, Spiel oder Schweißungen, die bei Produktionsprozessen oftmals auftreten, aber auch Unregelmäßigkeiten im Material (z. B. Welligkeit) können auf diese Weise genau gemessen werden.

Das Fraunhofer-Institut für Mikroelektronische Schaltungen und Systeme IMS hat für dieses Verfahren einen hochgenauen CMOS-Bildsensor entwickelt und produziert. Dieser Sensor liefert die nötigen Daten für Bildsensoren am Fraunhofer IMS. Mit diesem Sensor können wir unseren Kunden Abstellplatzmerkmale in punkto Geschwindigkeit und Dynamik geben, die im europäischen Wettbewerbsvorteil am Markt verschaffen. Mit Hilfe des hochpräzisen Bildsensors können auch extrem schwierige Oberflächen wie beispielsweise spiegelnde Metallflächen wie beispielsweise in der Automobilindustrie vermessen werden. Die dabei notwendige Lichtintensität wird dem Reflexionsfaktor des Messobjekts automatisch angepasst.

# Die Trainingsmanager

Radfahren wie die Profis – kein Problem mit den neuen High-End-Bike-Computern «Bike and Body Control» von Trekloc. Mit Hilfe von mehr als 30 Funktionen können auch Freizeitradler damit ein individuelles Trainingsprogramm absolvieren. Speziell für Trekloc haben Fraunhofer-Forscher eine sichere kabellose Datenübertragung entwickelt.



Die neueste Technik kann man selber am PC lassen positionieren lassen. © Trekloc

Mit der Serie 88 2008 Alpin haben sich auch Profis alle Informationen im Blick. © Trekloc



Radfahren macht Spaß und hält fit – wer mit zu großem Gang und stark überhöhter Pedalfrequenz durch die Landschaft rast, tut sich jedoch selbst nicht Gutes. Der kabellose High-End-Bike-Computer «Bike and Body Control» von Trekloc hilft, das Tempo so zu halten, dass der Puls im optimalen Bereich bleibt. Das best Time also, heißt die Liane und ist das Allgemeinwissen. Die professionelle Bike-Computer-Familie von Trekloc richtet sich sowohl an Freizeitsportler, unterstützt aber auch Profis beim ambitionierten Training für Weltkämpfe der Spitzensportler. Mit mehr als 30 Funktionen haben Profis mit der neuen Serie 88 2008 sogar alle wichtigen Informationen schnell und sicher parat. Zu den gängig-

sten Daten wie Pulzfrequenz, Geschwindigkeit oder zurückgelegte Kilometer können Informationen über Höhe oder Steigung.

Erzmal wird hier die störungsfreie kabellose digitale Datenübertragung «Radio Select» eingesetzt, die in den Laboren des Fraunhofer-Instituts für Mikroelektronische Schaltungen und Systeme IMS in Duisburg in Zusammenarbeit mit Trekloc entstand. Hans-Christian Müller und sein Team entwickelten die neue geschickte Messwert- und Funkübertragung. «Das wird am Rahmen des Vorderrads und an einer Speiche ein Sensor angebracht, der jedes Mal, wenn sich der Vorderrad des Bikes dreht, die Radumdrehung misst. Bisher funktionierten diese Technologie nicht störungsfrei, schon die Signal eines nebenan fahrenden Rads, einer Straßenbahn, aber auch ein Handy oder PC konnte Fehler bei der Datenübertragung verursachen», erklärt der Experte. «Jetzt werden die Messwerte bereits innerhalb der Sensortysteme digital verarbeitet und anschließend zusammen mit Sicherungsdaten an den Fahrradcomputer übertragen.»

Die Signalkommunikation erfolgt lediglich unidirektional, ohne Interaktion zwischen Sender und Empfänger. Dies ermöglicht den Einsatz kostengünstiger Komponenten. Ein ebenfalls ein IMI entwickelter und zum

Feldtest angepasster Antikollisions-Mechanismus stellt die zuverlässige Übertragung der Messwerte von jedem Sensor an den Fahrradcomputer sicher. Das heißt, auch die gemessenen Pulswerte werden störungsfrei übertragen. Eine weitere Besonderheit: Die Daten des Fahrradcomputers lassen sich per Funk zu einem PC übertragen. So kann der Radfahrer im Nachhinein die Strecke nicht nur in Geolinen Revue passieren lassen. Eine detaillierte Analyse von Puls- und Trittfrequenz, Geschwindigkeit und Höhe ermöglicht eine individuelle Anpassung des Trainingsprofils an die nächste Tour.

Im Trend: neue Funktionen sichern geringeren Energieverbrauch

Eine weitere Besonderheit der Trekloc Bike-Computer ist der geringe Energieverbrauch. Denn: «Damit sind und fällt die Auswahl der Hauptenergie elektronischer Fahrradcomputer», weiß Müller. «Ummer drücken, energieeffizientes Übertragungssystem reduziert den Verbrauch ebenso wie die «Wake-up-Mechanismen, die dafür sorgen, dass sich Sensor und Fahrradcomputer beim Laufen automatisch einschalten.» Das neue System ist so sparsam, dass handelsübliche Knopfzellen mindestens ein Jahr lang gemeinsamen Bike-Verzögerungen zurecht kommen.

## Fraunhofer Magazin 03/2008

### Messen

#### Drucksensor im Auge

> Ein erhöhter Druck im Auge (Grüner Star) kann zu Gesichtsfeldausfällen oder gar Erblindung führen. Zusätzlich neigen die Betroffenen im Alter auch oft zum Grauen Star. Die Linse trübt sich und muss operativ durch eine künstliche ersetzt werden. Damit danach der Augeninnendruck einfacher zu überprüfen ist, entwickeln Forscher vom Fraunhofer-Institut derzeit einen winzigen Sensor, der in der künstlichen Augenlinse sitzt und so vor Ort den Augeninnendruck messen kann. Der Sensor soll in zwei bis drei Jahren marktreif sein. Mit einem Zusatzgerät kann der Patient dann selbst den Druck im Auge kontrollieren. >



Wissen + Gesundheit 01/2008

### KOMPAKT

#### „NextHotelLab“: Rohbau ist fertig

DUISBURG (RP) Stabübergabe im dreistöckigen Forschungsbau auf dem Gelände des InHaus-Innovationszentrums der Fraunhofer-Gesellschaft an der Lotharstraße in Neudorf. Auf der Baustelle haben die Mauer- und Zimmerleute ihre Arbeiten abgeschlossen. Jetzt übernehmen die Forscher der Fraunhofer-Gesellschaft zusammen mit den Experten der Lindner Hotels das Geschehen. Auf rund 800 Quadratmetern gestalten sie die vier Musterküche – im Forscherjargon „Labs“ – des „NextHotelLab“. Realisiert werden zur Eröffnung im November zunächst das FutureHotel Showcase und das FlexibleLab.

Rheinische Post 03.09.2008

## Die Region als Hightech-Standort

WISSENSCHAFTLICHE Die Zusammenarbeit mit dem regionalen Wirtschaft mit wissensbasierten Forschungsaktivitäten ist ein wichtiger Schritt für die Entwicklung innovativer Produkte. Durch ein „Minderheitsbündnis“ in dieser Hinsicht noch ein großes an Hochschulen, an die beteiligten Partner der gerade im letzten gemeinsamen Initiative „Wissensbündnis“ und insbesondere am „NextHotelLab“, kurz „NHL“. Die „Minderheitsbündnis“ Industrie- und Hochschullösungen – Duisburg-Weed-Kolleg und Fraunhofer-Innovationen in der Region haben sich damit zum Ziel gesetzt, den Know-how-Transfer zwischen Wirtschaft und Wissenschaft zu erleichtern.



Die Gründer (v.l.) Detlev Balthus, Anton Grahmann, Peter Walden, Eckart Haeberlein, Stefan Bartschlagener, Wolf-Gerdhard Bratt, Stefan Jung.

schonungsorientierten Ende zwar stark, nicht aber weiter fortsetzt werden, so die Senatoren BEX, Udo-Wesche Duisburg-Essen, Fraunhofer-Institut für Mikroelektronische Schaltungen und Systeme Duisburg, Institut für Energie- und Umwelttechnik (IUTA), Duisburg, Institut für Metall- und Leichtmetalltechnik (IML), Essen-Lindorf. Das soll durch beschleunigtem Wissensaustausch und die Zusammenarbeit gelingen. Dazu gehören, HighTech für die Unternehmen schneller nutzen zu können, Technologiezentren zu bilden, kleine und mittlere Unternehmen an EU-Forschungsprogramme heranzuführen sowie die Hochschullösung im Bereich der technischen Berufe zu verbessern.

Rheinische Post 02.01.2008

## Feldforschung – ganz real

### Fraunhofer IMS-Sensornetze in der Landwirtschaft

Für den normalen Beobachter mag es ungewöhnlich erscheinen, das Ingenieure aus dem Bereich der Halbleiterforschung ihre Experimente und Messungen im Freien und nicht im Labor durchführen, aber genau das machen momentan Mitarbeiter des Fraunhofer-Instituts für Mikroelektronische Schaltungen und Systeme (IMS) aus Duisburg.

nen Messstation, die es ermöglicht, unterschiedliche physikalische Werte zu messen.

Ziel dieses, von der Euroregio geförderten, Projektes ist es, die



Photo Fraunhofer IMS

Auf einem Kartoffelfeld im jenseitigen Emsenrich interessieren sich die Forscher aus Duisburg aber weniger für die Pflanzen, als für das auf dem Kartoffelfeld von ihnen installierte drahtlose Sensornetz. Dieses Funknetz besteht aus kleinen Funkplatinen, die in der Lage sind selbstständig miteinander ein Funknetz aufzubauen und Daten zu einer Basisstation zu senden. Ausgestattet mit Sensoren wird

klimatische Veränderungen direkt in der Umgebung der Pflanze zu messen und daraus Rückschlüsse für die weitere Behandlung zu ziehen. Ferner erhoffen sich die Mitarbeiter der Landwirtschafts-

## Beschaffungsdienst Gallabau April 2008

### Was kosten die Kartoffeln?

Preisschilder an Supermarktreagen zu ändern, ist meist mit Rennerei für die Angestellten verbunden. Mit einem System von vernetzten Displays kann

das Personal die Preise anpassen. Forscher des Fraunhofer-Instituts für Mikroelektronische Schaltungen IMS in Duisburg haben das System mit der Firma renzel media entwickelt. Über einen zentralen Rechner im Büro kann der Filialeiter die Preise unkompliziert aktualisieren. Dazu wurde in jedem Screen am Regal ein Empfänger integriert. Über einen Sender im zentralen Computer lassen sich die Displays einzeln ansteuern. Sind etwa Erdbeeren im Sonderangebot, muss der Filialeiter lediglich die Datei, die den neuen Preis enthält, in das Hauptverzeichnis kopieren – und schon aktualisiert sich die Anzeige am Erdbeer-Regal. Die Software, mit der die Preisschilder erstellt werden, liefert die Firma renzel media mit.



Mit vernetzten elektronischen Displays lassen sich die Preise im Supermarkt leichter anpassen. © Fraunhofer IMS

Fraunhofer Magazin 03/2008



## Tourismus Schunkeln im Nirwana

Forscher entwerfen das Hotel der Zukunft. Der Gast kann dort in ungeheuren Annehmlichkeiten schlafen. Allerdings muss er in Kauf nehmen, dass er bis ins Detail angeleuchtet wird.

**T**ausende Kilometer von zu Hause entfernt ist das Wasser bereits heiß, die Witterung angenehm lau und der Bett entstehend komfortabel. Doch wenn der Hundstun ausbricht auch der ersten Nacht dann die Augen aufschlagt und aus dem Fenster schaut, blüht er in die Höhe. An seinem Vorgarten mit feiner Sicht auf das Grundstück, auf dem der angelegte Nachbar wohnt. Ein Alptraum?

Vermutlich nur der Scherz einer überzogenen Phantasie. Derzeit schlafen auch die jedoch ansonsten durchaus als Fortschritt gelten. In dieser Woche eröffnet die Fraunhofer-Gesellschaft im Rahmen einer Art Laboratorium, das einzig seinem Ziel gewidmet ist: Gesucht wird nach dem Hotelstandard für das 21. Jahrhundert.

1000 Quadratmeter Forschungsfläche stehen dafür in dem Duisburger Zentrum zur Verfügung. Schon existiert der Prototyp eines Zimmers, wie es Reisende in nächster Zukunft erleben werden.

Die tolle Herberge hat nur noch wenig gemein mit der traditionellen Unterkunft. Einmal mehr ist es die Qualität, die den Kunden herausheben wird. Hier schon erwartet der künftige reise Kunde

an die entsprechende Stimmung einer Lounge im Sonderbereich Berlin-Mitte.

Der Gast empfängt ein Personalmitglied in der Form einer überdimensionalen Kaffeebohne. Zugleich soll der Unbekannte hier ganz traditionell die Aussicht genießen. Am Abend lässt sich der Schreiber im Hochstuhl in eine Liegenwand verwandeln, auf der Flügel abgestellt werden können.

Doch damit nicht genug: In die wünschenswerte Fläche lassen sich per digitale Bildschirme einlesen - etwa wenn in der Hotelanlage ein Zimmer oder eben vom Ausblick aus dem Eigenheim.

Mit dieser Spezies werden sich die Fraunhofer-Gesellschaft bereits im kommenden Winter in eine Richtung verheißende Zukunft für die künftige Hotelbranche. Denn von der ist es auch Ansicht der Wissenschaftler außerordentlich schön bestellt. „Selbst in den besten Hotels in Deutschland ist vieles nicht zu Ende gefahren“, sagt Klaus Scherer, der Leiter des Duisburger Innovationszentrums.

Wie weit ist es schon das Ausland? Was der Deutsche auf Reisen geht, muss er das Resort mindestens gar nicht mehr

verlassen - er kann ja im Hotel selbst die tollsten Dinge erleben.

In einer Lockenklasse in Dubai etwa ist die Abendgesellschaft mit Blick auf ein imposantes Aquarium, in dem Rochen und andere Meerestiere umherstreifen.

Noch näher an der Natur schlägt der Gast in des Unterwasserzimmers jenseits der Welt. So das dortige ohnehin langweilig anmutende. Selbst die komplette Abwesenheit jeglicher Lärms kann zum futuristisch anmutenden Erlebnis werden. In schwimmenden Zimmern wird der Tourist in einem bei einem Grad Celsius davorgetriebenen Lichtfeld auf Polarkontinenten - dem Sternkontinent - sein eigenes Gefühlsleben genießen können.

Der deutsche Gastgewerbe kommt dagegen denkbar weit- und einflussreich dabei. „Hier betreten Sie mit dem Hotelbesitzer eine Innovationszone“, lautet die Zentralsache Scherer. „Da haben Sie dann einen Rufvernehmer, und das war's.“ Angesichts solcher Missstände wandert er wenig, wenn die Kundlichkeitsmaßnahmen der Gegenwart ergriffen. Gäre in Japan etwa ist das Nichts ganz dem Hotelwesen im Bad lauter, damit ein Mensch mitunter Schritte in die Perle des Jahrhunderts dringt, berichtet Hotelmanager Scherer.

Der Steuerung des Raumklimas gilt entsprechend die besondere Aufmerksamkeit der Fraunhofer-Forscher. Als vertikales Schichtenbild dessen kann jene noch immer unzureichendes Konzepte, in denen die Temperaturüberlagerung nicht regierbar ist. Für das Projekt hat die Laborleitung deshalb einen speziellen Treppchen

bedingte Hausbuch: Was es bereits gibt - was noch kommt

## Geräte mahnen die Wartung an

Sie warnen den Energieverbrauch aus und informieren bei Bedarf den Service. Auch in Hamburg ist dies bald schon möglich.

Hans-Jing Meier

„Dieser Tag, hier ist die Firma Meyer. Das Heizung hat sich bei uns zur Wartung angemeldet.“ So könnte Dialog zwischen Hausbesitzer und Dienstleister in Zukunft lauten, wenn es nach den Forschern des Fraunhofer-Innovationszentrums (IZ) geht.

Das entscheidende Element ist das heute schon existiert. „Wir konzentrieren uns auf den Fehler“, sagt Jürgens. „Wir wissen, dass die Heizungsanlage, die wir heute in den Häusern haben, sehr alt ist.“ Auf Energieeffizienz, Wohnen im Alter und Dienstleistungen, die das Wohlbefinden im eigenen Haus steigern.

Genau Energieeffizienz ist ein großes Thema. Laut Angaben des Bundeswirtschaftsministeriums (BWK) verbrauchten im Jahr 2006 private Haushalte 30 Prozent der gesamten in Deutschland konsumierten Energie. (Zur Vergleich: In einem durchschnittlichen Haushalt werden 100 Kilowattstunden (kWh) verbraucht.) „Aber bei dem Preis für eine Kilowattstunde Strom müssen die meisten Menschen sparen.“ Weil in diesem Punkt Wärme und Energie fehlen, muss hier immer noch viel erreicht werden.

erweitert.

„Was weiß schon, dass in einem Haus die Heizungsanlage einen Bedarf von 20 bis 30 Watt Stromleistung haben. Das ist die gleiche Energiemenge, die von einem Personal-Mikrowellenprodukt verbraucht wird“, betont Jürgens. „Man versteht deshalb den Bedarf der Heizungsanlage und kann entsprechende Informationen zum Verbrauch zur Verfügung zu stellen.“

Großes Augenmerk legt auch auf dem Thema Wohnen im Alter. „Langsam setzt sich die Erkenntnis durch, dass es nicht nur die barrierefreie Dusche ist, die einem ein langes Wohnleben in den eigenen vier Wänden ermöglicht“, so Jürgens. „Aber es gibt auch andere Möglichkeiten, um ein langes Leben zu ermöglichen.“ Dazu gehören zum Beispiel ein intelligentes System, das die Heizung über den Zustand des Patienten informiert, wenn bestimmte Abfälle in dem Haus nicht den vorgegebenen Profilen entsprechen. Bewegung sich dagegen alle im zweiten Kabinen, wenn der Patient nicht befehligen. Man könnte auf dem Wege eine sehr große das Betreuungsbedarf feststellen und ihn anpassen. Auch Medikamente oder andere Vorkehrungen können automatisch nachbestellt werden, wenn ein bestimmtes Verhalten beobachtet wird.

So wie das Innovations- und die Duisburger Technologie schon heute ein intelligentes System entwickelt sei, werde es allerdings noch ein bis fünf Jahre dauern.

Im Hamburger Innovations-Park werden erste Entwicklungen bereits in die

Praxis umgesetzt: In den denkmalgeschützten Gebäuden des ehemaligen Fraunhofer- und Verwaltungsbaus der Hamburger Zigarettenfabrik entstehen bis zum Sommer 2008 37 experimentelle Mietwohnungen. Dazu installiert die Fraunhofer-Gesellschaft eine Smart-Grid, die den gesamten Stand der Fließleistung und Erzeugung in diesem Bereich steuert. „Die Technologie ermöglicht eine dynamische Stromverteilung und eine intelligente Energiemanagement mit hohen Bedarfsanforderungen durch leicht bedienbare Displays“, erklärt Geschäftsführer Klaus Scherer. Darüber hinaus sollen in Zusammenarbeit mit dem Fraunhofer-Institut für Produktionstechnik und Fertigungstechnik in Braunschweig Service-Wohnen im Bereich Service-Wohnen (www.szw.fraunhofer.de) entwickelt werden. Darunter werden intelligente Heizungsanlagen, wie die monatliche Abrechnung von Energie, eine Verbrauchsanalyse mit Verbrauchsvorhersagen oder der Zugriff auf ein elektronisches Adressbuch für die angeschlossenen Geräte. Diese Informationen sollen besser nutzbar sein, wenn eine Dritte aus dem Haus kommt, die das Haus nutzt, geschied wird.

Spiegel 45/2008

GEDANKENSCHMIEDE FÜR INNOVATIVE IDEEN

## Reise nach Übermorgen

Auf 600 Quadratmetern erforscht die Fraunhofer-Gesellschaft das Urlaubsdomizil der Zukunft. Zwei der vier Musterküche sind gestern geöffnet. Wissenschaft trifft Wirtschaft

Von Margarete de Clair

Duisburg hat sich gestern eine Innovation für Touristen aus aller Welt zu bieten: Das neu eröffnete Fraunhofer-Innovationszentrum für die Zukunft der Reise. Das Fraunhofer-Institut für die Zukunft der Reise hat sich gestern eine Innovation für Touristen aus aller Welt zu bieten: Das neu eröffnete Fraunhofer-Innovationszentrum für die Zukunft der Reise.

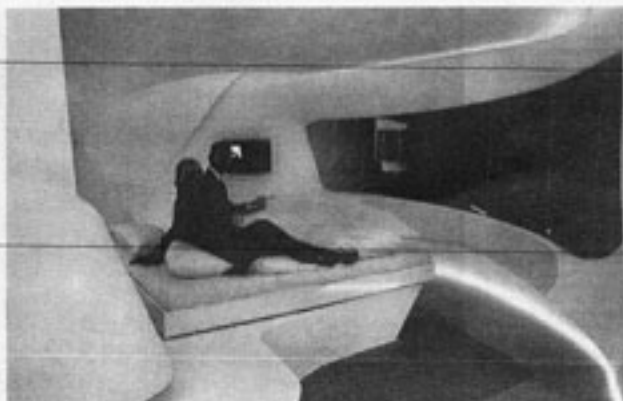

Entspannung soll leichter werden das Futurhotel-Duisburg zeigt, wie die Zukunft aussehen könnte. Foto: Angelika Batti, st-ort

Influenz2

Das Fraunhofer-Institut für die Zukunft der Reise hat sich gestern eine Innovation für Touristen aus aller Welt zu bieten: Das neu eröffnete Fraunhofer-Innovationszentrum für die Zukunft der Reise.

Erweiterung des Futurhotel-Duisburg. Statt Küche und Konten prüfen in persönlich gehaltenen Kassen und Büros. Ein großer Personalassistent wird auf Wunsch und Knopfdruck aus Display auf dem Tisch vor dem neuen Einfließen gesteuert oder Videokonferenzen abhalten kann.

Ein weiteres der „Lebe“-Konzepte Musterküche zeigt, wie beweglich Wände sein können. Im Flexibel-Lab werden die einzigen Hotelzimmer der Zukunft erforscht, die sich in ein Wohnzimmer, ein Büro, ein Schlafzimmer oder zwei Einzelzimmer verwandeln lassen. Die Räume in der Zukunft hat begonnen, zum Gewöhnlichen umher.

Anhand der Konzepte werden weitere vier weitere Lebe für das Fraunhofer-Institut für die Zukunft der Reise entwickelt. In der Zukunft wird es um Technik gehen, während im Flexibel-Lab die Sinne des Gastes angesprochen werden sollen. Die Räume in der Zukunft hat begonnen, zum Gewöhnlichen umher.

Allgemeine Hotel und Gastronomie-Zeitung 05.01.2008

WAZ 06.11.2008

# Blinde sehen wieder Licht

Im Aachener **Optik-Klinikum** wurde eine Sehprothese vorgestellt, die Patienten mit **Netzhautschwund** wieder eine rudimentäre Wahrnehmung ermöglicht. Sie können dann zumindest Lichtpunkte, Umriss und Helligkeit erkennen.

VON GISEL HANSMANN

**AMOR** Linsen und Gläser erkennen? Das ist für viele Blinde ein Problem. „Die Patienten sind sehr dankbar, wenn sie wieder etwas sehen können“, sagt Professor Dr. Volker Dierker, Leiter der Augenklinik im Aachener Optikum. „Man kann als Blinder nur durch die Hände und den Gehörapparat mit der Welt verbunden sein. Das ist ein sehr einsames Leben.“

## „Dieses System hat alle Vorteile auf seiner Seite“

beginnt, die jetzt am Aachener Optikum vorgestellt wurde, ist das erste, das eine rudimentäre Wahrnehmung ermöglicht.



Im Aachen vorgestellt: Ein Exemplar der weltweit ersten implantierbaren Sehprothese.

Die Sehprothese besteht aus einem kleinen Empfänger, der in das Auge implantiert wird, und einem externen Sender, der an der Hand getragen wird. Der Empfänger besteht aus einer Kammer, die Licht in elektrische Signale umwandelt. Diese Signale werden über einen Draht zum externen Sender übertragen, der sie über eine Antenne in Form von Lichtpunkten, Umrissen und Helligkeit wieder in die Welt überträgt.

Die Sehprothese ist ein Beispiel für die neuesten Entwicklungen in der Medizintechnik. Sie ermöglicht es, die Sehprothese zu implantieren und sie über einen Draht mit einem externen Sender zu verbinden. Der Empfänger besteht aus einer Kammer, die Licht in elektrische Signale umwandelt. Diese Signale werden über einen Draht zum externen Sender übertragen, der sie über eine Antenne in Form von Lichtpunkten, Umrissen und Helligkeit wieder in die Welt überträgt.

Die Sehprothese ist ein Beispiel für die neuesten Entwicklungen in der Medizintechnik. Sie ermöglicht es, die Sehprothese zu implantieren und sie über einen Draht mit einem externen Sender zu verbinden. Der Empfänger besteht aus einer Kammer, die Licht in elektrische Signale umwandelt. Diese Signale werden über einen Draht zum externen Sender übertragen, der sie über eine Antenne in Form von Lichtpunkten, Umrissen und Helligkeit wieder in die Welt überträgt.

# Funkchip im Auge

## Neue Sehprothese für Blinde

Sechs erblindete Menschen haben dank einer neuartigen Sehprothese teilweise ihr Augenlicht zurück bekommen. Zumindest „helle Flecken“ hätten die Versuchsteilnehmer wieder ausmachen können, teilte Projektleiter **Wolfgang Mokwa** von der RWTH Aachen am Montag mit. Das besondere an dieser Prothese sei, dass sie ohne Kabel funktioniere. Das weltweit einzige drahtlose System vereinfache die Handhabung für die Patienten mit der Erbkrankheit **Retinitis pigmentosa**, sagte Mokwa. Das System besteht aus einem in die Netzhaut eingepflanzten Mikrochip, der Signale von einer Kamera empfängt. Bei bisherigen Systemen wird der Datentransport per Kabel durch den Schläfenknochen erledigt. Darauf kann das Aachener System verzichten, da der implantierte Chip Funktionssignale von außen empfangen kann. Das Bundesforschungsministerium fördert das Projekt seit 1995 mit 17,5 Millionen Euro. Nach Abschluss der ersten erfolgreichen Tests wird das Projekt nun durch die Firma **Epirote** in Gießen weiter getragen. In zehn Jahren sollen Blinde mit Hilfe solcher Retina-Implantate wenigstens wieder Konturen in ihrer Umgebung wahrnehmen können. **hach**

## Ständig unter Druck

(Jenseitig) Durch die Integration von kleineren, hochkomplexen Implantaten in das menschliche Körper sollen komplizierte Messungen der Vitalparameter wie z.B. Aggregationsdruck, Blutzucker, Hämoglobin und Blutdruck durch tragbare, das die Patienten sich in ihrer Haut verbergen können. Die Entwicklung von Sensordaten aus dem menschlichen Körper stellt hohe Anforderungen an medizinische Implantate. Das Fraunhofer IMS in Duisburg hat sich der Lösung dieser anspruchsvollen Aufgabe angenommen und entwickelt vielfältige

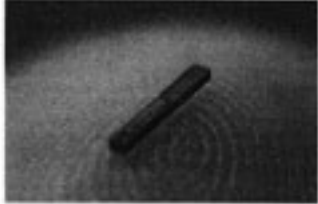

„Klein, aber fein“: Implantat auf einer Fingerkuppe

kleinere und behandelbare Arten in Zukunft des Arbeitsalltags und ermöglichen den Patienten eine optimale Kontrolle ihrer Vitalfunktionen.

Die kleinen drahtlosen Helfer besitzen integrierte kapazitive Druck- und Temperatursensoren und erfassen die physiologischen Parameter in ihrem jeweiligen Implantationsort. Über eine Antennenanlage, die dem Implantat gleichzeitig zur Energiegewinnung dient, werden die Messwerte in einen externen Lesegerät

Implantationsort. Diese liefern meist auf batteriebetriebenen Transpondersystemen mit kapazitiven Oszillationsdruck- und temperaturabhängigen Auswertungen, welche die Messwerte mittels elektromagnetischer Kopplung aus dem Körperinneren übertragen. Die geringe Größe sowie das energieeffiziente Funktionsprinzip gewährleisten eine kontinuierliche und problemlose Kontrolle jeglicher Druckparameter im menschlichen Körper. [www.ims.fhg.de](http://www.ims.fhg.de)

## Rheinische Post 12.03.2008

### Implantat: Drucksensor im Auge

Seitens werden sich zunehmend in der Sehprothese. Die Sehprothese ist ein Beispiel für die neuesten Entwicklungen in der Medizintechnik. Sie ermöglicht es, die Sehprothese zu implantieren und sie über einen Draht mit einem externen Sender zu verbinden. Der Empfänger besteht aus einer Kammer, die Licht in elektrische Signale umwandelt. Diese Signale werden über einen Draht zum externen Sender übertragen, der sie über eine Antenne in Form von Lichtpunkten, Umrissen und Helligkeit wieder in die Welt überträgt.

Die Sehprothese ist ein Beispiel für die neuesten Entwicklungen in der Medizintechnik. Sie ermöglicht es, die Sehprothese zu implantieren und sie über einen Draht mit einem externen Sender zu verbinden. Der Empfänger besteht aus einer Kammer, die Licht in elektrische Signale umwandelt. Diese Signale werden über einen Draht zum externen Sender übertragen, der sie über eine Antenne in Form von Lichtpunkten, Umrissen und Helligkeit wieder in die Welt überträgt.

Die Sehprothese ist ein Beispiel für die neuesten Entwicklungen in der Medizintechnik. Sie ermöglicht es, die Sehprothese zu implantieren und sie über einen Draht mit einem externen Sender zu verbinden. Der Empfänger besteht aus einer Kammer, die Licht in elektrische Signale umwandelt. Diese Signale werden über einen Draht zum externen Sender übertragen, der sie über eine Antenne in Form von Lichtpunkten, Umrissen und Helligkeit wieder in die Welt überträgt.

Süddeutsche Zeitung 11.03.2008

## Fraunhofer-Preis

# Kabellose Sehprothese

Erkrankungen der Netzhaut führen weltweit bei etwa 30 Millionen Menschen zum Erblindenden. Zwölf Jahre lang wurde im Projekt **EP-RET** daran gearbeitet diesen Patienten zu helfen. Entstanden ist ein weltweit einzigartiges System: eine komplett implantierbare Sehprothese.

Zwölf Jahre lang arbeiteten Neurochirurgen, Medizintechniker, Informatiker und Mediziner an einer Sehprothese für Patienten, die im Augenlicht durch Erkrankungen der Netzhaut erblindet sind. Im September 2007 fand die Studie in der Berliner Klinik mit sechs Patienten wurde die erste Sehprothese implantiert. Die erste Sehprothese ist ein Beispiel für die neuesten Entwicklungen in der Medizintechnik. Sie ermöglicht es, die Sehprothese zu implantieren und sie über einen Draht mit einem externen Sender zu verbinden. Der Empfänger besteht aus einer Kammer, die Licht in elektrische Signale umwandelt. Diese Signale werden über einen Draht zum externen Sender übertragen, der sie über eine Antenne in Form von Lichtpunkten, Umrissen und Helligkeit wieder in die Welt überträgt.



Die Sehprothese ist ein Beispiel für die neuesten Entwicklungen in der Medizintechnik. Sie ermöglicht es, die Sehprothese zu implantieren und sie über einen Draht mit einem externen Sender zu verbinden. Der Empfänger besteht aus einer Kammer, die Licht in elektrische Signale umwandelt. Diese Signale werden über einen Draht zum externen Sender übertragen, der sie über eine Antenne in Form von Lichtpunkten, Umrissen und Helligkeit wieder in die Welt überträgt.

Die Sehprothese ist ein Beispiel für die neuesten Entwicklungen in der Medizintechnik. Sie ermöglicht es, die Sehprothese zu implantieren und sie über einen Draht mit einem externen Sender zu verbinden. Der Empfänger besteht aus einer Kammer, die Licht in elektrische Signale umwandelt. Diese Signale werden über einen Draht zum externen Sender übertragen, der sie über eine Antenne in Form von Lichtpunkten, Umrissen und Helligkeit wieder in die Welt überträgt.

Fraunhofer Magazin 03/2008

## Praxis Physiotherapie 02/2008

Die Sehprothese ist ein Beispiel für die neuesten Entwicklungen in der Medizintechnik. Sie ermöglicht es, die Sehprothese zu implantieren und sie über einen Draht mit einem externen Sender zu verbinden. Der Empfänger besteht aus einer Kammer, die Licht in elektrische Signale umwandelt. Diese Signale werden über einen Draht zum externen Sender übertragen, der sie über eine Antenne in Form von Lichtpunkten, Umrissen und Helligkeit wieder in die Welt überträgt.

## Durchblick im Herzen

Zwei Forscher haben ein kleines Gerät entwickelt, das durch Blut hindurchströmen kann. In einem eigenen Internetauftritt wollen sie die Einführung perfektionieren und vermarkten.



Die Sehprothese ist ein Beispiel für die neuesten Entwicklungen in der Medizintechnik. Sie ermöglicht es, die Sehprothese zu implantieren und sie über einen Draht mit einem externen Sender zu verbinden. Der Empfänger besteht aus einer Kammer, die Licht in elektrische Signale umwandelt. Diese Signale werden über einen Draht zum externen Sender übertragen, der sie über eine Antenne in Form von Lichtpunkten, Umrissen und Helligkeit wieder in die Welt überträgt.

Die Sehprothese ist ein Beispiel für die neuesten Entwicklungen in der Medizintechnik. Sie ermöglicht es, die Sehprothese zu implantieren und sie über einen Draht mit einem externen Sender zu verbinden. Der Empfänger besteht aus einer Kammer, die Licht in elektrische Signale umwandelt. Diese Signale werden über einen Draht zum externen Sender übertragen, der sie über eine Antenne in Form von Lichtpunkten, Umrissen und Helligkeit wieder in die Welt überträgt.

Die Sehprothese ist ein Beispiel für die neuesten Entwicklungen in der Medizintechnik. Sie ermöglicht es, die Sehprothese zu implantieren und sie über einen Draht mit einem externen Sender zu verbinden. Der Empfänger besteht aus einer Kammer, die Licht in elektrische Signale umwandelt. Diese Signale werden über einen Draht zum externen Sender übertragen, der sie über eine Antenne in Form von Lichtpunkten, Umrissen und Helligkeit wieder in die Welt überträgt.

Technology Review Juni 2008

## Deutsches Ärzteblatt 07.01.2008

# Arbeitswelten

## Die Hoffnung im Auge

Die Sehprothese ist ein Beispiel für die neuesten Entwicklungen in der Medizintechnik. Sie ermöglicht es, die Sehprothese zu implantieren und sie über einen Draht mit einem externen Sender zu verbinden. Der Empfänger besteht aus einer Kammer, die Licht in elektrische Signale umwandelt. Diese Signale werden über einen Draht zum externen Sender übertragen, der sie über eine Antenne in Form von Lichtpunkten, Umrissen und Helligkeit wieder in die Welt überträgt.

Die Sehprothese ist ein Beispiel für die neuesten Entwicklungen in der Medizintechnik. Sie ermöglicht es, die Sehprothese zu implantieren und sie über einen Draht mit einem externen Sender zu verbinden. Der Empfänger besteht aus einer Kammer, die Licht in elektrische Signale umwandelt. Diese Signale werden über einen Draht zum externen Sender übertragen, der sie über eine Antenne in Form von Lichtpunkten, Umrissen und Helligkeit wieder in die Welt überträgt.



Fraunhofer-Journal 05/2008

Copyright 2008 by  
Fraunhofer-Gesellschaft  
Hansastraße 27 c  
80686 München

ISSN 1435-0874  
Annual Report  
Fraunhofer-Institut für  
Mikroelektronische  
Schaltungen und Systeme

Director:  
Prof. Dr. rer. nat. A. Grabmaier

Adresses:  
IMS Duisburg  
Finkenstraße 61  
47057 Duisburg  
Phone +49 (0) 2 03/37 83-0  
Fax +49 (0) 2 03/37 83-2 66  
E-mail  
martin.van.ackeren@ims.fraunhofer.de  
Internet [www.ims.fraunhofer.de](http://www.ims.fraunhofer.de)

Editorial Staff: Martin van Ackeren



Warenkorb

Bestand

Suchen

Verfügbare Gerichte

Rezepte aus der Zeit

Produkteigenschaften

**Gefüllte Paprikaschoten**



**Gefüllte Paprikaschoten**

**Zutaten:**

- 200 g Fleisch
- 200 g Reis
- 100 g Zwiebeln
- 100 g Karfiol
- 100 g Paprika

Suchen

Verfügbarkeit überprüfen

Warenkorb

Warenkorb

Systeminfo

Küche

Kühlen

Heizung

Licht

Medien

Hilfe

Wohnhaus