

## **Renewable integration and primary control reserve demand in the Indian power system**

**Autoren: A. Kannan, W. Heckmann, D. Strauß-Mincu**

Veröffentlicht:

1st International Conference on Large-Scale Grid Integration of Renewable Energy in India, New Delhi, India, September 06-08, 2017

Kontakt:

Fraunhofer-Institut für Windenergie und Energiesystemtechnik, IWES

Anlagentechnik und Verteilungsnetze

Netztechnik und Integration

Königstor 59

34119 Kassel

[www.energiesystemtechnik.iwes.fraunhofer.de](http://www.energiesystemtechnik.iwes.fraunhofer.de)

# Renewable integration and primary control reserve demand in the Indian power system

Arun Kannan

Division Systems Engineering  
and Distribution Grids  
Fraunhofer IWES  
Kassel, Germany  
[arun.kannan@iwes.fraunhofer.de](mailto:arun.kannan@iwes.fraunhofer.de)

Wolfram Heckmann

Division Systems Engineering  
and Distribution Grids  
Fraunhofer IWES  
Kassel, Germany

Dr. Diana Strauss-Mincu

Division Systems Engineering  
and Distribution Grids  
Fraunhofer IWES  
Kassel, Germany

**Abstract**— Control reserves are very important for power system operators in order to avoid large frequency deviations and secure a stable grid. India is currently in the process to quantify and establish control reserves. This paper mainly presents the estimation of primary control reserve or frequency containment reserve (FCR) within the Indian national grid by sizing it equal or larger than the reference incident. The estimated FCR has been analyzed by creating a step load disturbance equal to FCR by considering the system peak load condition. Further, the investigation of frequency response is carried out with the reduction of directly coupled aggregated inertia constant due to the integration of renewable energy sources (RES) by modelling a single area power system and a single mass model using Simulink.

**Keywords:** control reserves, primary control reserve or FCR, inertia constant, reference incident, renewable energy sources or RES, single area power system, single mass model, fast frequency reserve or FFR

## I. Introduction

In a complex interconnected electrical power system, the balance between generation and load is critical for the system operation within a frequency range of 50 Hz  $\pm 0.1\%$  to  $-0.2\%$  [1]. However, any disturbance in the power system in the form of outage of power plants, load forecast error, outage of transmission line due to overloading and high penetration of renewables with uncertainties in the available generation output is causing a deviation in the frequency away from its set value. This deviation of frequency is initially dependent on the aggregated inertia constant ( $H$ ) of the system and the load damping constant ( $D$ ) which is supported by a passive share of the network-frequency-dependent load [2]. However, the integration of RES into the electrical grid leads to a reduction of  $H$ , which is due to the massive grid integration of energy sources with non-rotational mass, that do not have stored kinetic energy like conventional generation does. Modern wind turbines have stored kinetic energy but are connected to the electrical grid through power electronic converters. Therefore, with the reduction in  $H$  increases the rate of change of frequency (ROCOF) and consequently the load shedding and generation shedding during an under-frequency and over-frequency event respectively.

In order to avoid large frequency deviations, the creation of control reserves becomes very important.

The dynamical hierarchy of the reserves release is depicted in Figure 1.

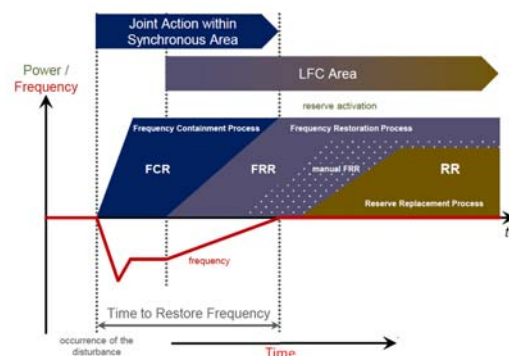

Figure 1: Dynamic hierarchy of Load-Frequency Control (LFC) [3]

The first conventional control reserves is FCR which is provided fully within a few seconds, usually 30s [4], after the occurrence of frequency deviation due to a disturbance. The release of FCR within the whole synchronous area during a disturbance stabilizes the frequency at a new quasi-steady state value within the permissible maximum frequency deviation in the time frame of seconds. The frequency restoration reserve (FRR) controls the frequency towards its set point value by activation of FRR and replaces the activated FCR. The reserve replacement (RR) replaces the activated FRR and/or supports the FRR by activation of the reserve replacement process (RR) [5].

In India, even though FCR is compulsory according to the Indian Electricity grid Code (IEGC) [6], there is no information on how much reserve should be available all the time. The generators which are in service do not provide sufficient reserves from their installed capacity due to technical difficulties or commercial reasons. Due to this, load shedding has to be activated during the under-frequency operation [7]. In order to avoid the forced shutdown of customer loads, the dimensioning of FCR is very important so that the reserve power would be activated for any frequency change beyond the operating limits.

The basic requirement of FCR is to withstand the reference incident (which is defined as an event which is large enough to create a maximum instantaneous power deviation between generation and demand in the synchronous area [5]) such that the system frequency will be within the maximum

frequency deviation immediately after the disturbance and stabilizing the system frequency within the maximum quasi-steady state frequency deviation without activating any automatic load shedding. The reference incident has to take into account the maximum power imbalance between generation and demand in the synchronous area and can be found by taking into account at least:

- the loss of the largest power plant
- the loss of a line section
- the loss of a bus bar
- the loss of the largest load at one connection point, as well as
- the loss of a HVDC interconnector

that might lead to the biggest active power imbalance with an (N-1) failure. However, within a large synchronous area, there is a certain probability of dependent or even independent double faults. Therefore, (N-2) criterion is considered for dimensioning the reference incident for the synchronous area in continental Europe [5].

## II. System modelling

The electrical power system is non-linear and time-varying in nature. However, a simple low-order linearized model can be used to analyze frequency control during load disturbance because the frequency response dynamics are relatively slow, ranging from seconds to minutes [2].

### A. Generation-load model

The swing equation of a synchronous machine in case of a small perturbation is given by (1)

$$\Delta f_r(s) = \frac{f_0}{2HG} * [\Delta P_m(s) - \Delta P_e(s)] \quad (1)$$

where H is the aggregated inertia constant in MWs/ MVA, G is the total rated power of the generators in MVA (base power),  $f_0$  is reference grid frequency in Hz,  $\Delta f_r$  is small change in rotor frequency in Hz,  $\Delta P_m$  is small change in mechanical power in MW,  $\Delta P_e$  is small change in electrical power in MW [2].

In general, power system loads are a composite of various electrical devices. Resistive loads consume power independent of frequency. The motor loads draw electrical power changes with frequency due to changes in motor speed. The overall frequency-dependent characteristic of a composite load may be expressed as

$$\Delta P_e = \Delta P_L + D \cdot \Delta \omega_r \quad (2)$$

where  $\Delta P_e$  is small change in electrical power in MW,  $\Delta P_L$  is non-frequency load change in MW,  $D\Delta\omega_r$  is frequency sensitive load change in MW. The equation (1) is again rewritten as

$$\Delta f_r(s) = \frac{f_0}{2HG} \cdot [\Delta P_m(s) - \Delta P_L(s) - D \cdot \Delta \omega_r] \quad (3)$$

### B. Prime mover model

In this paper, it is assumed that the FCR is provided only by conventional generation. Therefore, only steam turbine modelling is considered. The time constant of the turbine controllers is assumed as a time delay caused by the presence of the re-heater, since the delays between the control valves and the high- and low-pressure turbines are significantly smaller. The time delay is represented as below

$$\frac{\Delta P_m}{\Delta P_v} = \frac{1}{1+T_h \cdot s} \quad (4)$$

where  $\Delta P_v$  is change in steam valve position in MW,  $\Delta P_m$  is small change in mechanical power in MW,  $T_h$  is time constant of the turbine caused by the presence of re-heater which is considered to be 5s [8].

### C. Governor model

The governor adjusts the steam/hydro/gas turbines valve/gate to bring the frequency back to the scheduled value whenever there is increase/decrease in the electrical load. The detailed characteristic of such a governor is shown in Figure 2.

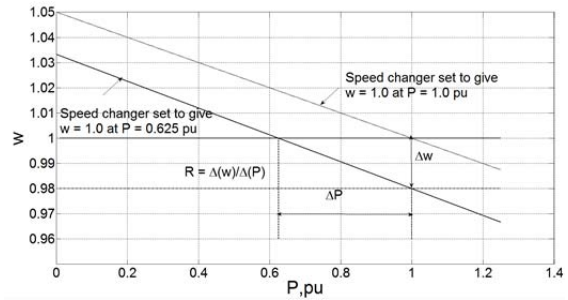

Figure 2: Governor steady-state speed characteristics [9]

The slope of the curve represents the speed regulation R which determines the steady-state speed versus load characteristic of the generating unit [8]. The mechanism of speed governor acts as a comparator whose output  $\Delta P_g$  is given by (5)

$$\Delta P_g = \Delta P_{ref} - \frac{1}{R} \cdot \Delta f \quad (5)$$

where  $\Delta P_{ref}$  is reference set power in MW, R is speed regulation or droop in Hz/MW,  $\Delta f$  is frequency deviation in Hz. The  $\Delta P_g$  is transformed to the steam valve position using amplifier in a linear fashion and represented in the form of a simple time constant in s-domain as

$$\Delta P_v(s) = \frac{1}{1+T_g \cdot s} * \Delta P_g(s) \quad (6)$$

where  $T_g$  is the governor time constant,  $\Delta P_v$  is the change in steam valve position. By combining all the equations in s-domain form, we obtain the complete block diagram of a generating unit with a steam turbine and governor with frequency control loops by considering the load change  $\Delta P_L$  as input and frequency deviation  $\Delta f$  as the output and the block diagram is implemented using Simulink which is shown in Figure 3. Some of the additional control

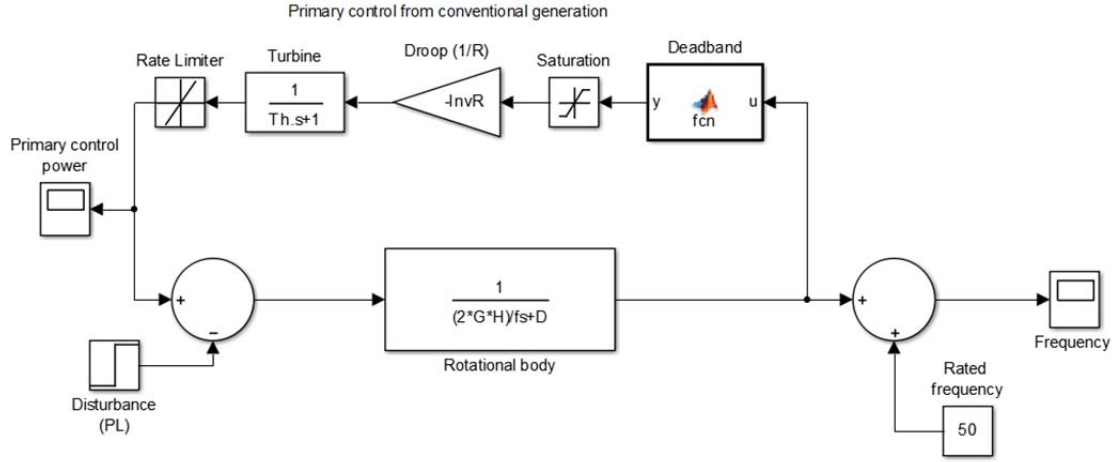

Figure 3: Simulink model of a load frequency control of a single area system

blocks are considered in the Simulink model and the reason for modelling these control blocks are explained below.

- The dead-band control block is considered such that the primary control activation is not triggered until the frequency deviation towards the nominal frequency is exceeded by  $\pm 30$  mHz [6].
- FCR reacts instantaneously and shall achieve full activation at less than or equal to 30s, if the frequency deviation towards the nominal frequency is equal to  $\pm 200$  mHz [1]. Therefore, the same amount of primary control will be released even if the  $\Delta f$  is greater than  $\pm 200$  mHz. In order to limit the frequency deviation to  $\pm 200$  mHz, the saturation control block has been modeled (see Figure 3).
- Instead of the governor time constant, a rate limiter control block has been modeled such that the deployment of power would be varied with different ramp rates.
- In order to get the frequency deviation with respect to the nominal frequency, the output  $\Delta f$  will be added with the nominal frequency (50 Hz).

The complete Simulink model which is shown in Figure 3 represents the complete Indian national grid by considering the different control areas as a single area system and the entire turbine-generator model as a single mass model.

### III. Estimation of FCR demand

Based on the data received from [10], it has been observed that there are congestions in the transmission lines especially in the region of coastal Gujarat where there is an aggregated capacity of about 10,000 MW. Based on [11], the demand of Gujarat is low and the generation is very high which means that the Western region is having an excess of generation, mainly exported to other regions through a 400 kV transmission line that satisfies only the (N-1) contingency with the help of system protection scheme (SPS) [12]. However, from [10], [13], it is understood

that the large generating complex (3000 MW or above) should satisfy (N-2) contingency. Since there is a large export of generation from western region to the other parts, there is a possibility of cascading trips due to the overloading of the lines in the vicinity of this region. Due to this vulnerability, there is a chance of system split such that the Gujarat would be completely isolated from the rest of the grid due to overloading of the lines. In such a case, on one side, there would be excess of generation and low demand in Gujarat and on the other side, a shortage of generation and a high demand in the rest of the grid. This situation of not satisfying the (N-2) contingency which is leading to the possibility of system split is considered as the reference incident for the whole synchronous area of Indian power system.

Such a situation of system split was practically observed in Turkey in March 2015, due to multiple failures, the Western and Eastern subsystem of Turkey underwent a power deficit and surplus of about 4700 MW respectively [14].

Based on these assumptions, an outage of 8000 MW has been assumed as a credible contingency for the whole Indian power system. Therefore, a FCR of 8000 MW has been estimated for the entire synchronous area.

### IV. Case Studies

Studies have been carried out to analyze the frequency response of the Indian national grid for the estimated FCR during the step load disturbance. The parameters which are defined in the above Simulink model are discussed one by one.

The case studies are performed for system peak load. By referring the recent National load dispatch center (NLDC) monthly report (Especially from the month of September and October 2015), it has been recorded the highest peak load which is very close to 150 GW. Therefore, for the analysis, 150 GW has been considered as a system peak load which is same as total generated power (G) as shown in the equation (1). These case studies have been carried out by considering 8000 MW as the primary control contribution from the conventional generation. Studies

are performed with a step load disturbance equal to FCR of 8000 MW at 1s for different values of H to check the dynamic frequency response. Different values of H from 1 MWs/MVA to 6 MWs/MVA in step of 1 MWs/MVA are considered to understand how the system behavior changes because it reduces as more renewables are added into the system. Since there is no information of the contribution from RES and conventional generation for different values of H for Indian power system, the relative comparison has been brought by considering the German power system. The H of close to 5 MWs/MVA has 100% contribution from conventional generation, H of close to 2.6 MWs/MVA has 47% contribution from RES and H of close to 1 MWs/MVA has 80% contribution from RES [15]. This is given in order to give a feeling of how much RES and conventional generation contributes for different values of H.

The load damping constant D of 3-4%/Hz has been considered based on [16]. In order to represent D in terms of MW/Hz, it has to be calculated in the following manner. We know that the system peak load is 150 GW. Therefore,

$$\text{With } D = 3\%/Hz$$

$$D = 3/100 * 150 \text{ GW} = 4500 \text{ MW/Hz}$$

$$\text{Similarly, with } D = 4\%/Hz$$

$$D = 4/100 * 150 \text{ GW} = 6000 \text{ MW/Hz.}$$

As we know, the estimated FCR of India is 8000 MW which will be activated fully, if there is a frequency deviation of +/-200 mHz. Therefore, the droop characteristic R is calculated as

$$1/R * 200 \text{ mHz} = 8000 \text{ MW}$$

$$1/R = 40000 \text{ MW/Hz}$$

Rate limiter is defined as the rate at which all the primary control reserve of 8000 MW should be activated within 30 s. Therefore,

$$\text{Rate limiter} = 8000 \text{ MW}/30 \text{ s}$$

$$\text{Rate limiter} = 266.667 \text{ MW/s}$$

All the studies are performed and the results are judged based on the below factors:

- One of the first factor is the maximum frequency deviation or in other terms minimum frequency point. This metric is very important with respect to the frequency stability of the power system and management frequency control (i.e. performance of the primary and secondary control and coordination of the reserves). The value of the metric is  $\pm 1000$  mHz in 50 Hz systems. The reason being that the load shedding at different locations based on the priority of the type of load will start from 48.8 Hz [17]. After considering some measurement errors and safety margin, maximum frequency deviation of  $\pm 1000$  mHz has been considered.
- The second factor is selected as the time to reach the minimum frequency point. The

minimum frequency point and the time to reach this point are determined by the energy released during the inertial response stage. The time to reach the minimum frequency point has an influence on the frequency response stages. It affects the frequency control such as primary and secondary control [18].

Since there is no information available on how the ROCOF is measured, it has not been considered in the studies. Studies are carried out for different scenarios. The details of all parameters considered for all the scenarios are shown in Table 1.

## 1. Scenario 1

Studies have been carried out for  $D = 3\%/Hz$  and the FCR deployed within 30s at the ramp rate of 266.67 MW/s. Figure 4 indicates the behavior of the dynamic frequency response with step load disturbance of 8000 MW at 1s. The  $\Delta f$  of 1045 mHz has been observed for the H of 6 MWs/MVA. As the H is reduced due to the introduction of more renewables, the  $\Delta f$  is increasing. Therefore,  $\Delta f$  of 1530 mHz for H of 1 MWs/MVA is the maximum which has been observed from the study. With the introduction of more inverter coupled RES, the H could decrease down to 1 MWs/MVA which results in an additional increase in  $\Delta f$  of 485 mHz compared with H of 6 MWs/MVA. The time to reach minimum frequency point is also reduced as the H is decreased. All the  $\Delta f$  observed for different H are not within the maximum  $\Delta f$  of +/- 1000 mHz and quasi steady state  $\Delta f$  settles at slightly more than 49.8 Hz due to the FCR and therefore, it is within the maximum permissible quasi-steady-state deviation of +/-200 mHz [4]. The activation of primary control power for all H during peak load condition is shown in Figure 8.

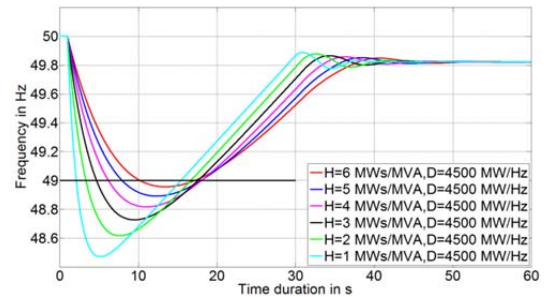

Figure 4: Dynamic frequency response for Scenario 1

## 2. Scenario 2

Studies have been carried out by considering  $D = 4\%/Hz$  and the FCR deployed within 30s at the ramp rate of 266.67 MW/s. Figure 5 indicates the dynamic frequency response with the  $\Delta f$  of 860 mHz has been observed for the H of 6 MWs/MVA. It has been observed that the  $\Delta f$  for H of 3 MWs/MVA is 1016 mHz which is marginally higher but satisfies the maximum  $\Delta f$  of 1000 mHz. With further reduction in the H due to more inverter coupled RES, the  $\Delta f$  of 1182 mHz for H of 1 MWs/MVA has been observed from the study. All the  $\Delta f$  observed with H less than 3 MWs/MVA are not within the maximum frequency

Table 1: Parameters considered for different scenarios

Scenarios	Disturbance PL (MW)	Peak Load G (GW)	Self-regulating loads D (MW/Hz)	Inertia H (MWs/MVA)						Rate limiter (MW/s)	Droop 1/R (MW/Hz)
				6	5	4	3	2	1		
Scenario 1	8000	150	4500	6	5	4	3	2	1	266.667	40000
Scenario 2			6000							*400	
Scenario 3											
Scenario 4										**800	

\*400 MW/s rate limiter means, all the primary control reserve would be activated within 20s (i.e. 8000 MW/20s)

\*\*800 MW/s rate limiter means, all the primary control reserve would be activated within 10s (i.e. 8000 MW/10s)

deviation of +/- 1000 mHz. Quasi steady state frequency settles at slightly more than 49.8 Hz which is within the maximum permissible limit of +/-200 mHz. The activation of FCR for all variations of H during peak load condition is similar to Figure 8.

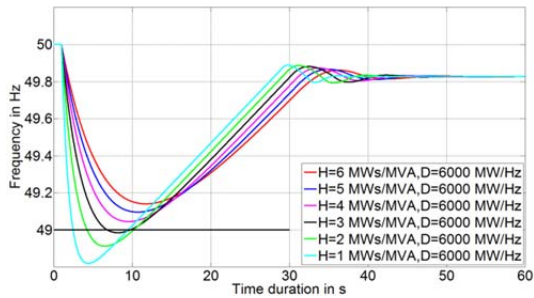

Figure 5: Dynamic frequency response for Scenario 2

### 3. Scenario 3

Studies have been carried out for  $D = 4\%/Hz$  with a much faster rate of FCR deployed within 20s at the ramp rate of 400 MW/s. This scenario is being carried out to check the behavior of the system frequency with a faster FCR. Faster FCR or fast frequency response (FFR) could be provided by inverter coupled generators/storage, thus mitigating the described challenges in systems with low H values. The faster deployment of FCR is qualitatively possible with the combination of conventional generation and RES. However, further investigations need to be performed to calculate the share between them to reach the all the primary reserve activation within 20s. Figure 6 indicates that the maximum frequency deviation increases with the decrease in H. All the  $\Delta f$  observed for  $H \leq 1$  MWs/MVA are not within the maximum  $\Delta f$  of +/- 1000 mHz. Quasi steady state  $\Delta f$  is within the permissible limit of +/-200 mHz. The activation of FCR for all the values of H is shown in Figure 8.

### 4. Scenario 4

Studies have been carried out for  $D = 4\%/Hz$  with a much faster rate of FCR deployed within 10s at the ramp rate of 800 MW/s compared to all previous scenarios. This scenario is being carried out to check the behavior of the system frequency with a fast FCR. The faster deployment of FCR is qualitatively possible with the combination of conventional generation and RES. However, further investigations need to be performed to calculate the share between

them to reach the all the primary reserve activation within 10s. Figure 7 indicates that the maximum frequency deviation increases with the decrease in H. All the  $\Delta f$  observed for  $H \leq 1$  MWs/MVA are not within the maximum  $\Delta f$  of +/- 1000 mHz. Quasi steady state  $\Delta f$  is within the permissible limit of +/-200 mHz. The activation of FCR for all the values of H is shown in Figure 8.

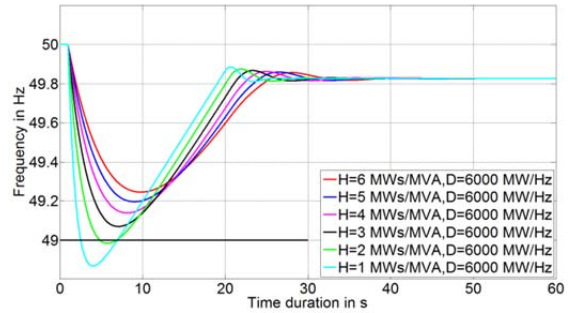

Figure 6: Dynamic frequency response for Scenario 3

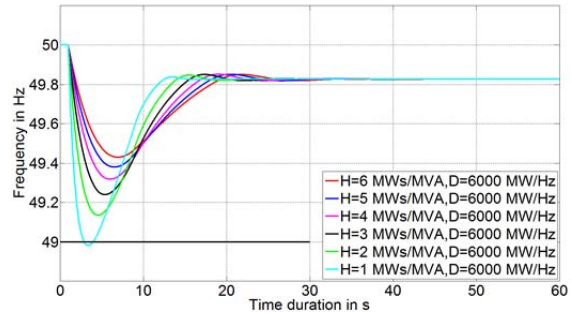

Figure 7: Dynamic frequency response for Scenario 4

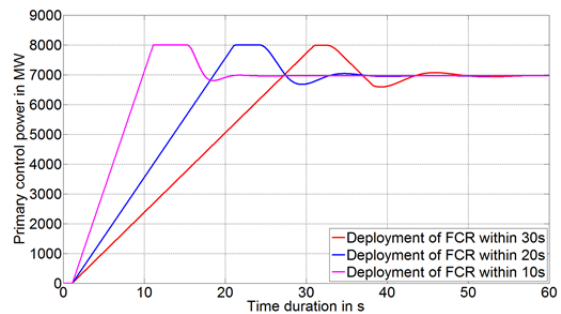

Figure 8: Deployment of FCR with different ramp rates

The summary of all the scenarios is shown in Figure 9. It gives information of how both maximum frequency deviation and time to reach minimum

frequency point varies when the H values are varied from 1 MWs/MVA to 6 MWs/MVA. It can be understood from the figure that there is a large frequency deviation and the time to reach the minimum frequency point is faster if H is reduced. However, both of them improve, if the FCR is activated much faster for the different values of H.

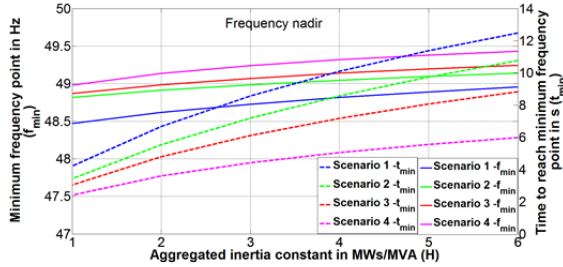

Figure 9: Variation of the frequency nadir in the 4 investigated scenarios for different values of H

## V. Conclusion

The paper presents the estimation of FCR for the entire Indian national grid by considering the worst case scenario and by analyzing the behavior of system frequency with the estimated FCR for a step load disturbance in the Indian power system by using a Simulink model. The power system stability has been analyzed for the case of H reduction due to high shares of inverter coupled RES. All results and findings presented in this paper are based on a single area system and a single mass model. From this paper, several observations have been noted. Firstly, the increase in the percentage of inverter coupled RES reduces H and increases  $\Delta f$  and also the time to reach the minimum frequency point is faster.

Secondly, the higher the D, there is less reduction in the maximum  $\Delta f$  and therefore the system  $\Delta f$  recovers very fast with a better quasi-steady state  $\Delta f$  with the help of FCR.

Finally, considering the current situation of the Indian power system, the contribution of renewables is very low compared with the conventional generation during the peak load condition. Therefore, it is very safe to assume the value of aggregated H to be more than 3 MWs/MVA. With  $D = 4 \text{ \%}/\text{Hz}$  during the peak load condition, the operational metrics of maximum  $\Delta f$  is within the allowable limit of  $\pm 1000 \text{ mHz}$  and steady frequency deviation is within the allowable limit of 49.8 Hz.

However, in future, with higher shares of inverter coupled RES, there is a necessity to provide the inertial response in order to maintain the system frequency within the allowable range. This could be provided from RES as FFR which can be activated immediately ( $< 2$  seconds) for a time span of up to several seconds after the disturbance [19]. The FFR can be provided by RES by means of deloaded operation (i.e. creating a power reserve by operating the units at a sub-optimal operating point), energy storage systems (ESS) and other technologies. Also, the estimated FCR demand for the entire Indian

national grid needs to be analyzed frequently in order to maintain the frequency within the allowable maximum frequency deviation.

## VI. Acknowledgement

The authors would like to thank the support from POSOCO in furnishing the data. The research work has partly been performed within the framework of a GIZ project related to the "Green Energy Corridors" investigations. The authors are solely responsible for the content of this publication.

## VII. References

- [1] "Central electricity regulatory commission," New Delhi, India, January 2014.
- [2] H. Bevrani, "Robust Power System frequency Control", Springer, PP. 15-17, 2009.
- [3] "ENTSO-E: Supporting Document for the Network Code on Load-Frequency Control and Reserves," June 2013.
- [4] A. Ulbig, T. S.Borsche and G. Andersson, "Impact of low rotational inertia on power system stability and operation," April 2014.
- [5] M. d. I. T. Rodriguez, M. Scherer, D. Whitley and f. Reyer, "Frequency Containment Reserves Dimensioning and Target Performance in the European Power System," July 2014.
- [6] CERC, "Indian Electricity Grid code," New Delhi, India, April 2010.
- [7] CERC, "Annexure1, Report of the committee on spinning reserve," New Delhi, India, September 2015.
- [8] P. Kundur, "Power System Stability and Control", McGraw-Hill, Inc, PP. 425, 1994.
- [9] H. Saadat, "Power System Analysis", New York: The McGraw-Hill Companies, 1999.
- [10] POSOCO, "Reliable operation of the Mundra generation pocket in coastal Gujarat," New Delhi, India, December 2012.
- [11] POSOCO, "Prioritization of elements for removal of congestion based on criticality and frequency of congestion," New Delhi, India, November 2010.
- [12] POSOCO, "Prioritization of Transmission systems under implementation to relieve congestion," New Delhi, India, March 2015.
- [13] CEA, "Draft report of national electricity plan - Transmission (Volume 2)," India, February 2012.
- [14] ENTSO-E, "Report on Blackout in Turkey on 31st March 2015," September 2015.
- [15] I. A. Nassar and H. Weber, "Influence of Increasing Intermittent Renewable Energy Sources on the Power System," in Konferenz für Nachhaltige Energieversorgung und Integration von Speichern - NEIS 2013, September 2013.
- [16] NRPC, "Under frequency load shedding scheme in Northern Region (NR)," New Delhi, India, January 2010.
- [17] "Procedure for assessment of frequency response characteristic (FRC) of control areas in Indian power system," New Delhi, India.
- [18] M. Altin, U. Annakkage, F. Iov and P. Kjaer, "Methodology for Assessment of Inertial Response from Wind Power Plants," in IEEE PES general meeting, July 2012.
- [19] F. Van Hulle, I. Pineda and P. Wilczek, "REserviceS - Economic grid support services by wind and solar PV," September 2014.